



# ARM Group Inc.

Earth Resource Engineers and Consultants

December 19, 2017

Ms. Barbara Brown  
Project Coordinator  
Maryland Department of the Environment  
1800 Washington Boulevard  
Baltimore, MD 21230

Re: Maintenance Cleanup Plan – Tin Mill Canal  
Transmittal of Revised Pages  
Tradepoint Atlantic  
Sparrows Point, MD 21219

Dear Ms. Brown:

On behalf of EnviroAnalytics Group, LLC (EAG), ARM Group Inc. (ARM) is providing the attached revised pages of the Maintenance Cleanup Plan for the Tin Mill Canal (Revision 2 – November 28, 2017) to the Maryland Department of the Environment (MDE) and United States Environmental Protection Agency (USEPA). The USEPA provided an email on December 12, 2017 which requested that the reporting plans for the project be modified to more specifically indicate the nature and schedule of progress submittals, and to indicate that the submittals will be provided to the USEPA and the MDE. In response to the USEPA's email, minor text revisions have been made to pages 21 and 23 of the Maintenance Cleanup Plan for the Tin Mill Canal to provide an additional explanation of the planned progress submittals and to confirm that they will be submitted to the USEPA and MDE. Hard copy replacement pages are attached for incorporation into the previously provided document, and the enclosed CD provides a compiled PDF of the entire report (Rev. 3 – 12/18/17) with the inserted replacement pages.

If you have any questions, or if we can provide any additional information at this time, please do not hesitate to contact ARM Group Inc. at 410-290-7775.

Respectfully Submitted,  
ARM Group Inc.

Stephen B. Fulton, P.E., P.G.  
Senior Engineer

Attachments:

(1) Revised pages 21 and 23 (Revision 3, dated December 18, 2017)

cc: Erich Weissbart - USEPA  
James Calenda - EAG

# MAINTENANCE CLEANUP PLAN FOR THE TIN MILL CANAL

TRADEPOINT ATLANTIC  
SPARROWS POINT, MARYLAND

Prepared For:



## ENVIROANALYTICS GROUP

1650 Des Peres Road, Suite 230  
Saint Louis, Missouri 63131

Prepared By:



## ARM GROUP INC.

9175 Guilford Road  
Suite 310  
Columbia, Maryland 20146

ARM Project No. 170208M

Respectfully Submitted,

A handwritten signature in black ink that reads "Stephen B. Fulton".

Stephen B. Fulton, P.E., P.G.  
Senior Engineer

A handwritten signature in black ink that reads "Neil Peters".

T. Neil Peters, P.E.  
Senior Vice President

## TABLE OF CONTENTS

---

1.0	Introduction.....	1
1.1.	Site Description.....	1
1.2.	Regulatory Setting.....	1
1.3.	Work Plan Objectives.....	2
2.0	Sediment Characterization Results .....	4
2.1.	Chemical Characterization .....	4
2.2.	Physical Characterization.....	4
2.3.	Remediation Waste Characterization .....	5
2.4.	Screening Level Risk Assessment.....	5
2.5.	Remediation Recommendations.....	6
3.0	Proposed Maintenance Cleanup Work for TMC .....	7
3.1.	General .....	7
3.2.	Planning Activities .....	7
3.2.1.	Outfall Survey.....	7
3.2.2.	Dewatering Studies .....	7
3.3.	Project Implementation .....	10
3.3.1.	Erosion and Sediment Controls .....	10
3.3.2.	Vegetation Removal.....	11
3.3.3.	Demolition/Removal of Structures .....	11
3.3.4.	Staging Area Construction.....	12
3.3.5.	Canal Water Management.....	12
3.3.6.	Sediment Excavation and PCB Vertical Delineation.....	13
3.3.7.	Handling and Dewatering of Excavated Sediments.....	15
3.3.8.	Waste Characterization and Disposal .....	16
3.3.9.	On-Site Waste Disposal .....	17
3.3.10.	Channel Restoration and Capping .....	18
3.3.11.	Equipment Decontamination and Removal .....	19
3.3.12.	Health and Safety Measures.....	19
3.3.13.	Dust Control.....	19
3.3.14.	Project Oversight and Documentation .....	21
4.0	Permits, Notifications and Contingencies.....	22
5.0	Implementation Schedule.....	23
6.0	References.....	24

## TABLE OF CONTENTS (CONT.)

---

### FIGURES

Figure 1	Area A & B Parcels.....	Following Text
Figure 2	Tin Mill Canal Site Plan .....	Following Text
Figure 3	Existing Tin Mill Canal Groundwater Wells.....	Following Text
Figure 4	Process Flow for PCB Sediment Removal Area .....	Following Text

### DRAWINGS

Sheet 1	Tin Mill Canal Removal Plan .....	Following Text
Sheet 2	Profile and Cross Sections .....	Following Text
Sheet 3	Tin Mill Canal Work Areas .....	Following Text
Sheet 4	Disposal Plan .....	Following Text
Sheet 5	Details .....	Following Text
Sheet 6	Details 2 .....	Following Text

### APPENDICES

Appendix A	Outfall Survey Summary .....	Following Text
Appendix B	Supporting Calculations.....	Following Text
Appendix C	Project Authorizations .....	Following Text
Appendix D	Landfill Berm Information.....	Following Text
Appendix E	TMC Sediment TCLP Information.....	Following Text



## 1.0 INTRODUCTION

ARM Group Inc. (ARM), on behalf of EnviroAnalytics Group (EAG), has prepared this Maintenance Cleanup Work Plan (Work Plan) for a portion of the Tradepoint Atlantic property that has been designated as Parcel B16, the Tin Mill Canal (TMC). In general, this Work Plan provides for the maintenance of the TMC through the removal of accumulated sediments from the canal to restore its flow capacity, followed by capping of the residual materials to provide for long-term protection of human health and the environment. The remedial activities presented in this Work Plan are based on the findings and recommendations of the “Sediment Characterization Report for the Tin Mill Canal – Revision 2” dated November 15, 2017, and also on the “Statement of Basis” for Parcel B16 Tin Mill Canal issued by the United States Environmental Protection Agency on July 25, 2017.

### 1.1. SITE DESCRIPTION

The TMC is a constructed swale that currently serves as a conveyance for stormwater runoff and groundwater base flow from an approximately 800-acre drainage area of the Sparrows Point site. Waters collected in the TMC are routed to the Humphrey’s Creek Waste Water Treatment Plant (HCWWTP) for treatment prior to discharge via the NPDES permitted Outfall 014. The average volume of water flowing through the canal to the HCWWTP during dry weather is approximately 3,000 gallons per minute (gpm), but can increase to over 50,000 gpm during storm events. The TMC is located in the central portion of the Sparrows Point property, south of Interstate 695 and Highway Route 158. An aerial photo that shows the location of the canal is provided as Figure 1.

The TMC is approximately 7,500 feet in length, 30 to 50 feet wide and 15 feet below grade. The canal was constructed from slag and includes numerous point discharges (outfalls) from the site storm sewer system. The eastern portion of the TMC began operating in the early 1950s. The western (remaining) portions of the canal and HCWWTP were completed and began operating in approximately 1969. Since its construction, the TMC has historically also conveyed wastewater discharged from numerous manufacturing facilities associated with former steelmaking and steel finishing operations at the Sparrows Point site. Over the years, some of the heavier particles and oils in the wastewaters from the steel manufacturing facilities have settled to the bottom of the TMC. The canal still receives and controls stormwater runoff from the Site; the HCWWTP remains operational to treat stormwater runoff prior to discharge. An outfall summary is included in Appendix A.

### 1.2. REGULATORY SETTING

Environmental actions for the TMC, and for the site in general, are being implemented pursuant to the following:

- Multi-Media Consent Decree (Decree) between Bethlehem Steel Corporation, the United States Environmental Protection Agency, and the Maryland Department of the Environment (effective October 8, 1997); this Decree has been modified in accordance with a stipulated order entered into by Sparrows Point LLC and the respective agencies effective July 28, 2014;
- Administrative Consent Order (ACO) between Sparrows Point Terminal, LLC and the Maryland Department of the Environment (effective September 12, 2014); and
- Settlement Agreement and Covenant Not to Sue (SA) between Sparrows Point Terminal, LLC and the United States Environmental Protection Agency (effective November 25, 2014).

The original Consent Decree for the Sparrows Point facility dealt with many issues associated with ongoing iron-making, steel-making, coking, byproduct, plating, and finishing operations. To the extent that these operations are no longer conducted, and the associated facilities no longer exist, many specific requirements of the Decree are no longer applicable and have been removed in accordance with the stipulated order implementing modifications to the Decree. The TMC is part of the acreage that remains subject to the requirements of the Decree as documented in correspondence received from EPA on September 12, 2014.

### **1.3. WORK PLAN OBJECTIVES**

In general, the objectives of the cleanup work for the TMC are to restore the canal surface to near the original grades, and to leave it in a condition that is protective of both human health and the environment. The proposed measures generally include the removal of solids settled within the canal and subsequent channel stabilization work as previously summarized in the Site Conceptual Cleanup Plan (SCCP; EAG, August 2014a).

As noted above, the canal has been used historically for the conveyance of both stormwater and wastewater to a central wastewater treatment plant (HCWWTP) prior to discharge to surface water through a NPDES-permitted discharge outfall. Materials that contain polychlorinated biphenyls (PCBs), oil/grease, and other constituents have been deposited in the TMC over time from process sewer discharges associated with the steel finishing operations. These materials are located within the entire length and width of the canal and affect water currently being controlled and discharged through the canal. The canal still receives and controls stormwater runoff from the Site; the HCWWTP remains operational to treat stormwater runoff prior to discharge.

Based on the site conditions, the proposed cleanup work focuses on the mitigation of future exposure pathways from contaminated sediment, impacts to stormwater conveyed by the canal, and elimination of contaminants from the aggregate TMC discharge requiring treatment at the HCWWTP as follows:

- Sediment - Prevent potential future direct exposure to contaminated sediments located within the TMC; and
- Surface Water - Mitigate impacts to stormwater conveyed by the TMC and reduce to the extent practical the need for ongoing treatment of stormwater at the HCWWTP.

To accomplish these goals, the proposed work includes removal and disposal of impacted sediments associated with the canal, and the installation of acceptable isolation and channel stabilization materials (i.e., engineered cap) above the sediments left in place to prevent direct contact exposures and support future stormwater conveyance through the TMC. Sediments will be excavated to restore the flow capacity and expose the currently buried discharge ends of outfall pipes along the canal. All impacted sediments currently in the TMC will be capped or removed, thereby rendering an assessment of potential ecological impacts unnecessary while achieving protection of water quality resources. These proposed measures and the supporting rationale are presented in the balance of this Work Plan.

## 2.0 SEDIMENT CHARACTERIZATION RESULTS

A detailed investigation of the TMC and associated sediments was conducted to support the planning and design of the maintenance work for the TMC. The results and recommendations from this detailed investigation were presented in the “Sediment Characterization Report for the Tin Mill Canal – Revision 2” dated November 15, 2017 (SCR), and the major findings and recommendations from that report are presented in this section to provide some additional background and basis for the proposed work.

### 2.1. CHEMICAL CHARACTERIZATION

Based on the significant sampling and testing conducted, the primary constituents of concern in the canal sediments include oil & grease and PCBs.

The oil & grease was generally detected throughout the canal. During former steelmaking operations, oils within contact wastewaters were managed through a series of baffles and oil skimmers installed at specific locations along the canal. While there is no specific action level for removal of sediments containing oil & grease, sediments will generally be removed along the entire length of the canal to allow for the removal of the existing oil-control structures, and as necessary to restore the flow capacity of the canal after allowing for the placement of a 2-foot thick barrier layer (cap). The proposed work has been designed to manage elevated levels of oil & grease that will be encountered during the sediment removal work so as to minimize discharges of oil & grease to the HCWWTP. The estimated total volume of sediments to be removed from the canal is approximately 72,000 cubic yards (see calculation in Appendix B).

Aroclor 1242, Aroclor 1248, Aroclor 1254, Aroclor 1260, and total PCBs were identified in sediment samples collected from the TMC. Several deep sediment samples exceeded the level that would warrant mandatory delineation and excavation of total PCBs (i.e., 50 mg/kg). The extent of the TMC where total PCBs were identified above 50 mg/kg has been laterally delineated as generally shown on Sheet 1 of the attached Drawings. Because samples with PCB concentrations over 50 mg/kg were from deep sampling depth intervals, further vertical delineation is required and is planned to be conducted during the sediment excavation process. Material exceeding the threshold of 50 mg/kg is required to be excavated and disposed of at a permitted off-site commercial landfill approved to accept TSCA-regulated PCB waste. The estimated volume of sediments to be excavated from the PCB-impacted area is approximately 9,000 cubic yards (see calculation in Appendix B).

### 2.2. PHYSICAL CHARACTERIZATION

As presented in the SCR, the sediments were typically described as dark black fine silt; oily/greasy; and sludge-like. The moisture content of selected samples ranged from 28 to 41.4%,

and dry densities ranged from as high as 109 pounds per cubic foot (pcf) for material described as dryish to 76.8 pcf for more typical material. Therefore, the excavated sediment will need to be dewatered, possibly with the use of drying agents, to remove free liquids to make it suitable for transport off-site or to the on-site Greys Landfill. Potential drying processes and reagents were evaluated through bench-scale testing as discussed later in this Work Plan.

### **2.3. REMEDIATION WASTE CHARACTERIZATION**

To support the proposed sediment removal activities, waste characterization activities were previously completed to determine disposal options for the excavated sediments. To supplement earlier waste characterization assessments, and as detailed in the SCR, Toxicity Characterization Leaching Procedure (TCLP) testing of discrete and composite sediment samples recovered from numerous transects along the canal was completed for regulated volatile, semi-volatile and metal constituents. Based on that sampling, no exceedances of the TCLP regulatory limits for hazardous waste were identified (details of the TCLP sampling activities and results, including sample location map and summary table, are provided in Appendix E). Furthermore, none of the maximum detected concentrations or maximum method detection limits (MDLs) for all hazardous constituents (except for PCBs) exceeded their respective health-based levels below which contaminated environmental media would be considered to no longer contain hazardous waste (“contained-in” criteria, i.e., Adjusted RSLs). Therefore, with the exception of sediment with concentrations of PCBs greater than 50 mg/kg, the contaminated environmental media that will be excavated from the canal will be considered “contained out” and will not require management as a hazardous waste unless future TCLP testing indicates otherwise.

Sediments or contaminated media containing total PCB concentrations greater than 50 mg/kg are subject to disposal requirements under TSCA. Therefore, material with total PCB concentrations greater than 50 mg/kg will be excavated and segregated for transport and disposal off-site to a permitted hazardous waste landfill approved to accept TSCA-regulated waste.

The sediments contain a high moisture content and exhibit the presence of free liquids. As a result, and to meet the applicable requirements for no free-draining liquids prior to transportation or disposal of solid waste, dewatering, potentially combined with drying agents, will be required prior to disposal in the on-site Greys Landfill or transport off-site to a TSCA-permitted landfill. As discussed in Section 3 of this Work Plan, treatability testing was conducted prior to full-scale implementation of the work in support of the development of an appropriate approach to eliminate free liquids prior to transportation and disposal.

### **2.4. SCREENING LEVEL RISK ASSESSMENT**

Based on an assessment of potential exposure risks as presented in the SCR, it was determined that institutional controls should be implemented for the protection of future site workers to ensure proper oversight and management of any future construction activity near the canal that

could involve temporary disturbance of the proposed TMC cap or contained materials (e.g., utility or road crossing). In addition, this Work Plan includes provisions for implementation of a site-specific health and safety plan during the work.

## **2.5. REMEDIATION RECOMMENDATIONS**

As presented in the SCR, sufficient remedial investigation data has been collected to evaluate the nature and extent of constituents of concern in the TMC and further investigation is not warranted. The following actions were recommended to restore the TMC's flow capacity and to cap residual materials to provide for long-term protection of human health and the environment:

- Sediments impacted by elevated PCBs (>50 mg/kg) in the northern portion of the TMC are required to be excavated. Lateral delineation has been completed, but the depth of sediments containing PCB concentrations greater than 50 mg/kg should be delineated during removal activities. Material exceeding the threshold of 50 mg/kg should be excavated and disposed of at a TSCA-permitted off-site landfill. Excavated sediments with concentrations of PCBs less than 50 mg/kg are considered non-hazardous and can be disposed at Greys Landfill.
- Supplemental excavation of sediments should be implemented to achieve appropriate hydraulic slope and cross-sectional area and to facilitate placement of an engineered barrier for protection of the current and future site worker and water quality in the canal discharging to Bear Creek in compliance with stormwater permit conditions. Sediments should be excavated to depths to restore the flow capacity subsequent to placement of the engineered barrier. This engineered barrier can be designed to help achieve acceptable stormwater quality for discharge without active treatment. Environmental capping, after excavation of sediments containing PCB concentrations exceeding 50 mg/kg, would be an acceptable remedy for protection of current and future site workers.
- Institutional controls should be implemented for the protection of future workers to ensure proper maintenance of the engineered barrier, as well as proper oversight and management of any future intrusive activity that would disturb sediments from below the cap. These institutional controls would include a requirement for written notice to the MDE of any future intrusive activities, and may require worker health and safety requirements for any excavations of substantial time periods, and proper management and characterization of any material disturbed at the Site.

## **3.0 PROPOSED MAINTENANCE CLEANUP WORK FOR TMC**

### **3.1. GENERAL**

The proposed work for the TMC is detailed in this section, with support from the attached Figures, Drawings and Appendices. As discussed above, the proposed work generally involves the following:

- excavation and removal of sediment from the TMC to address sediments with PCB concentrations greater than 50 mg/kg, and accumulated sediments that contain elevated levels of oil & grease that restrict the flow capacity of the canal; and
- restoration of the remaining slag fill and sediments by covering with an engineered barrier that will support acceptable future stormwater conveyance through the TMC and protect water quality.

### **3.2. PLANNING ACTIVITIES**

Prior to the start of equipment mobilization and sediment excavation activities, various planning and preparation activities have been or will be conducted to finalize the design plans and prepare for project implementation. The most significant of these activities are discussed in the following subsections.

#### **3.2.1. Outfall Survey**

In March of 2017 a detailed inspection and survey of the canal was conducted to support the final design and development of this Work Plan. Supplemental topographic surveying was conducted in August of 2017. This work included detailed topographic surveying of the canal invert and banks, identification of critical features and potential obstructions along the canal such as sand bars, scour areas, vegetation and trees, utilities, bridge abutments and other structures, and all influent pipes and outfalls, and additional details regarding the influent pipes and channels such as size, invert elevations, material of construction, flow rate (if any), and general condition. Findings from this investigation are generally summarized in Appendix A of this Work Plan, and are generally shown on Sheet 2 of the attached project Drawings.

#### **3.2.2. Dewatering Studies**

Based on the anticipated presence of free-draining liquids in the excavated sediments, and the need to eliminate free-draining liquids from any materials transported off-site or to the on-site Greys Landfill, bench and field-scale treatability studies have been conducted to help develop a practical and cost-effective approach to address this requirement. As discussed later in this Work Plan, it is currently anticipated that the dewatering process will involve the placement of



excavated sediments in windrows on a series of dewatering pads constructed along the canal to allow for gravity drainage of water, likely combined with the use of one or more drying agents with associated mechanical mixing processes. The bench and field-scale treatability study activities are described below:

- On August 4, 2017, sediment samples were collected from five locations along the TMC. These sediment samples were used for the bench-scale testing and geotechnical lab testing. The five locations were selected to present a reasonable worst case range of oil and water contents and sediment types anticipated to be encountered during the work (i.e., 3 of the samples were collected immediately upstream from existing oil-removal stations, along with an overall upstream location and a downstream location). Sample locations are shown on Figure 2. The samples were collected with an excavator working from the bank of the canal, and placed into a number of 5-gallon buckets for each location. A portable secondary containment device was used to prevent spillage of sediments during the sample collection activities. Sediment samples were not collected from the PCB-containing area.
- The collected samples were transported to the existing dewatering pad located near the upstream end of the canal. From each of the sample locations, one bucket of sediments was spread out on the dewatering pad to facilitate gravity drainage and air drying. A plastic tarp was placed over each of the sediment piles to prevent erosion and wetting during rainfall events.
- On August 22, 2017, samples of the collected sediments were placed into bottles and submitted to JLT Laboratories Inc. of Canonsburg, Pennsylvania for geotechnical analysis of the following: moisture content; grain size analysis; density; and permeability. For the moisture content tests, samples from each location were submitted of the raw (“Pre”) samples from the sealed buckets, as well as samples of the sediments that had been set out on the pad and allowed to air dry for approximately 4 days (“Post”). After initial laboratory screening of the samples, the laboratory concluded that too much oil was present in the samples and the requested grain size, permeability, and density tests could not be properly conducted. The moisture content tests are summarized in the table below:

<b>Sample</b>	<b>Moisture Content (%)</b>	<b>Sample</b>	<b>Moisture Content (%)</b>
TS1-Pre	97.74	TS1-Post	69.77
TS2-Pre	90.17	TS2-Post	60.41
TS3-Pre	76.77	TS3-Post	56.79
TS4-Pre	39.41	TS4-Post	30.88
TS5-Pre	24.68	TS5-Post	20.05



- On August 24, 2017, bench-scale testing was conducted for sediments collected from the five sampling locations. The bench-scale testing included the following assessments for eliminating free-draining liquids as necessary for on-site and off-site disposal: raw sediments (no amendments or exposure); sediments that had been allowed to air dry; and the sediments following the addition of various amounts of cement kiln dust (CKD), lime kiln dust (LKD), and phragmites (which had been collected previously and allowed to air dry for a few weeks). These assessments were completed using the EPA Paint Filter Liquids Test (Method 9095B) to determine the presence of free-draining liquids. Prior to starting the tests, all buckets of raw sediments were homogenized with a paint mixer. The test results are generally summarized below:
  - Three (TS1, TS3, and TS5) of the five raw (initial) samples failed the paint filter test. However, the sediment samples from all three of these locations that had been subjected to air drying passed the paint filter test.
  - Reagents (CKD and LKD) were hand mixed with the raw sediment samples starting with 5 percent (%) by volume and increasing in 5% intervals if necessary to pass the paint filter test. All samples passed the paint filter test with the addition of only 5% of CKD or 5% LKD, except for sample TS5 where the addition of 10% CKD was required to pass the paint filter test for CKD (it passed at 5% LKD).
  - The dried phragmites was chopped up and mixed into the sample with the highest water content (TS1) at approximately 10% and 20% by volume. The 10% mix of phragmites did not pass the paint filter test but the 20% mixture did pass.
- In addition to the free-liquid testing discussed above, oil stability tests and free liquid stabilization tests were also completed as discussed below:
  - The oil stability test was completed on sample TS2, which had a large amount of oil content observed in the settled liquid. LKD was added to the raw sediment sample at concentrations of 5%, 10%, and 20% (by volume) to assess the structural stability of the treated material. A 500 milliliter (mL) sample was mixed at the concentrations mentioned above and placed back in the 500mL beaker and turned upside down to release the sample from the beaker. The structural stability (based on observed slumping of the sample after being dumped from the beaker) increased with reagent concentration.
  - To help replicate the disturbance associated with off-site transportation of the materials, and to help ensure that free liquids are not created as a result of such

disturbance, samples were mixed with LKD starting with 5% and increasing in 5% intervals. The two test locations used for this test were TS2 (large amount of oil) and TS5 (large amount of water). TS2 was mixed in 5% intervals up to 30%, while TS5 was mixed in 5% intervals up to 20%. These mixes sat for approximately seven days and were then checked to see if any free liquid was observed. Based on field observations, no free liquids were observed in any of the samples that had been mixed with at least 20% LKD.

Due to the success of the LKD with free liquid stabilization at lower percentages than CKD and phragmites, it is currently planned that LKD will be the primary drying reagent utilized for this project. The final mix designs will be based on the sediment conditions encountered in the field during the work, and possibly the results of supplemental testing.

### **3.3. PROJECT IMPLEMENTATION**

Details of the proposed project implementation are presented in the following subsections of this Work Plan, with supporting information presented on the Drawings and Figures attached to the end of this document.

#### **3.3.1. Erosion and Sediment Controls**

Erosion and sediment controls will be installed prior to commencing work. These controls will be constructed in accordance with the 2011 Maryland Standards and Specifications for Soil Erosion and Sediment Control. The erosion and sediment control measures will generally include the following to prevent contaminated sediments from exiting the Site:

- Work will generally be conducted within or adjacent to the canal, allowing for any eroded sediments to be returned to the canal work area. The area surrounding the canal generally slopes towards the canal, and water in the canal is routed to the HCWWTP for treatment prior to discharge.
- The area of disturbance will be minimized at any one time, with the excavation work conducted between a section of canal that is isolated by upslope and downslope coffer dams to help control surface water and sediment erosion.
- Work will be conducted from upslope to downslope so that runoff from active work areas will not be directed across completed channel sections.
- Stockpiled sediments undergoing drying will be managed on a controlled dewatering pad with curbing, and will be covered with tarps if warranted to support erosion control.
- Following sediment removal in each section of the canal, the exposed canal bottom and side slopes will be capped and covered with an erosion-resistant rip-rap lining. Existing steep canal side slopes will be reduced to 2H:1V to improve long-term stability.

- Truck hauling roads to the on-site Greys Landfill will be periodically inspected and maintained (e.g., repair rutting, sweeping of excessive dirt, etc.) to control erosion and sediment migration.

Erosion and sediment control information, including sequence of construction, limits of disturbance, planned staging areas and haul routes, water control measures, and canal lining details are presented in the project drawing sheets attached to this Work Plan. As noted on Sheet 1 of the drawings, land disturbance associated with the overall site development activities will not be conducted within the TMC construction access area until the sediment removal and capping activities have been completed within that section of the TMC.

### 3.3.2. **Vegetation Removal**

Prior to the start of any earthmoving activities, vegetation within the planned area of sediment excavation, and also within planned staging and support areas, will be cut down to the ground surface. The removed vegetation will be segregated from the sediments to be excavated to minimize the volume of materials requiring special management as part of the work. Based on recent surveys of the canal, the significant majority of this vegetation consists of tall, perennial grasses (phragmites). Due to the volume of these grasses, and based on experience with other projects, these grasses will be spread out on the ground surface in the vicinity of the canal to facilitate air drying to reduce the moisture content and volume of these materials, and to render them potentially suitable for use as a sediment drying agent. If appropriate based on the sediment conditions encountered during the work, these grasses will be chopped or shredded following drying, and made available for incorporation into the excavated sediments to support the elimination of free-draining liquids from the sediments. The potential rate at which these grasses would be added to the wet sediments would be based on relevant field observations. Any removed vegetation not otherwise used (e.g., for sediment drying) or recycled (e.g., chipped for mulch), will be properly disposed.

### 3.3.3. **Demolition/Removal of Structures**

Some existing concrete, metal, and other structures along the canal will be removed during the course of the work to provide for equipment operation and support the excavation of sediments along the entire canal. These structures include utilities, oil-removal stations, fencing, canal crossing manways, inactive outfalls, and other features. Canal road crossings, active utilities and other features that can be worked around will not be demolished or removed. Existing monitoring wells that are located along the canal (see Figure 3) will be protected from damage or properly closed following approval from MDE. The portions of structures to be removed that are located above the canal sediments and water level will be demolished in a controlled fashion, with the resulting debris re-used on site as clean fill where appropriate (e.g., crushed concrete), or will otherwise be recycled (e.g., metal) or reused on site, or sent off-site for recycling or proper disposal. Structural components that are located below the canal sediment or water level

elevation will be kept within the vicinity of the canal following removal, and subsequently decontaminated through washing and removal of all visible debris and staining for reuse or off-site disposal, or will be crushed and used as excavation backfill below the final cap to be constructed along the canal. Structures that currently hold back water or restrict flow in the canal will generally be removed in a gradual and progressive manner starting at the upslope end of the canal. For demolition and removal of the oil-removal stations, any significant amounts of free-phase oils that could be released downstream will first be removed by skimming or pumping, and oil-absorbent booms or pads will be placed immediately downstream of the stations prior to and during removal of the stations to further help restrict the downstream migration of free-phase oils that have collected upstream of the stations. Recovered oils and oily wastes will be properly containerized and shipped off-site for recycling or disposal in accordance with applicable regulations.

#### 3.3.4. Staging Area Construction

To support the management of sediments excavated from the canal, a series of staging areas will be constructed along the canal as generally shown on the attached Drawings (Sheets 1 and 5), and potentially elsewhere along the canal as needed to provide for equipment access and staging during the work. As noted on Sheet 1, the staging area referred to as Dewatering Pad No. 1 is already in place, and it consists of a paved asphalt area measuring 150' by 150' constructed over an impermeable membrane and enclosed on three sides by a constructed earthen berm. Additional staging areas or material dewatering pads will be constructed along the canal with recycled asphalt or compacted slag fines underlain by a geomembrane liner, and will include a perimeter containment berm with vehicle access ramp, and will be sloped to drain back to the canal (for the non-PCB-contaminated areas) or into collection sumps at the corners of the pad (for the PCB-contaminated areas) as shown on Sheet 5 of the Drawings. The pads will be sized to provide sufficient area for the placement and management of excavated sediments for dewatering and mixing with drying agents if needed.

#### 3.3.5. Canal Water Management

Stormwater and groundwater discharging to the canal will be managed during the course of the work to help facilitate sediment excavation and to minimize sediment erosion and migration during the course of the work. A typical layout of the planned canal water management system is presented as the “Typical Channel Bypass Pumping” detail on Sheet 5 of the Drawings. The canal water management will initially be established at the upslope end of the canal, where the sediment removal activities will begin, and will then be moved progressively downstream as each section of the canal is excavated and then backfilled and capped. As shown on Sheet 5, the canal water management system will consist of two primary components as discussed below:

- Surface Water: Surface water flow in the canal upslope and downslope of the active work area will be controlled by a system of coffer dams and bypass pumping. Coffers

dams will be installed upstream and downstream of the active work area, and keyed into the canal bottom and sidewalls to help restrict water flow. It is currently anticipated that the coffer dams will be constructed of well-graded aggregate with 20-mil plastic liners, but sand bags or other barriers may alternately be used as indicated on the project drawings. Surface water in the canal upslope of the work area will then be pumped with a centrifugal trash pump or pumps that will be sized to accommodate low-volume storm events, although the coffer dams will be removed and the work will be suspended in the event of storm flows that exceed the available pumping capacity; in such a case in the PCB-contaminated work area, any exposed sediments will be covered to help prevent erosion and downstream migration. The pump intake will be established to minimize suspended solids in the pumped water, and the water will be discharged back to the canal at a location downstream of the active work area.

- Groundwater: Within the active work area between the coffer dams, groundwater (and any additional surface water that may enter the work area from direct runoff or via an existing outfall) will be removed from the work area by pumping with one or more dewatering pumps as necessary to facilitate excavation of the sediments. This water will also be pumped in a manner to minimize suspended solids, and will be discharged to the canal at a location downstream from the active work area. The dewatering pump(s) will be sized to accommodate the anticipated groundwater base flow to that section of the canal, plus some additional surface water flow. Groundwater pumped directly from the PCB-contaminated sediment work area will be treated to help remove PCBs prior to discharge to the canal as generally shown on Sheet 5 (Drawings) and Figure 4 (flow chart).

### 3.3.6. Sediment Excavation and PCB Vertical Delineation

Sediment excavation activities will be initiated following the removal of water from each active working section of the canal to the extent practical. In general, the sediment excavation activities will be conducted from excavation equipment working along one side of the canal, with the excavated sediments placed directly onto an adjacent dewatering pad, or transported to the nearest dewatering pad via sealed haul trucks. Prior to removal from the banks of the canal, and to the extent practical, the sediments will be moved to one side of the canal and placed into temporary stockpiles that can drain directly back into the canal to help remove the bulk of the free liquids. Loading will be conducted immediately adjacent to the canal to the extent possible so as to minimize potential sediment spillage beyond the canal. Plastic tarps, portable secondary containment pads, and/or similar measures will be used during truck loading activities where appropriate to help prevent sediment spillage to the ground surface beyond the canal. Any sediment that is inadvertently spilled or released to the ground during loading operations will be contained and/or over-excavated and managed with the excavated canal sediments.

Except for the area of PCB contamination (see Sheet 1 of the Drawings), which is discussed further below and where sediment excavation may be deeper, sediments will be excavated to restore the flow capacity and expose the currently buried discharge ends of outfall pipes along the canal (see Sheets 2, 5 and 6 of the Drawings for typical details). After the discharge end of any outfalls within the active work area are exposed, that section of outfall pipe, if 24 inches in diameter or larger, will be flushed out with pipe cleaning equipment, and the associated water and sediments will be directed to the active work area and managed concurrently with the canal water and excavated sediments; outfall pipes less than 24 inches in diameter will be capped and closed.

Sediments with PCB concentrations greater than 50 mg/kg will be removed within the previously delineated area of PCB contamination (see Sheet 1). Sediments from this reach of the canal will be managed separately from the sediments removed from the other sections of the canal because of additional protocols and controls associated with the management of PCB-impacted sediments and pore water. Although the lateral delineation of the PCB-impacted sediments has been completed, additional vertical delineation will be completed as part of the work to ensure that the sediment removal activities include all sediments greater than 50 mg/kg, and to allow for the segregation of any shallow sediments that may have PCB concentrations less than 50 mg/kg to minimize off-site disposal costs.

Prior to or during the sediment removal process in the PCB-contaminated area (shown on Sheet 1 of the Drawings, and based on the sampling results presented in the SCR), additional sampling of shallow sediments will be conducted to determine the depth of any sediments with PCB concentrations less than 50 mg/kg. For cost and timing reasons, sampling may initially be conducted with PCB field test kits (e.g., Clor-N-Soil) to provide an initial guide for the separate segregation of shallow sediments with concentrations less than 50 mg/kg, but with concentrations to be confirmed with laboratory testing prior to removal of the sediments from the contaminated soil dewatering pad. After excavation of the PCB-contaminated sediments has reached the known depth of PCB concentrations greater than 50 mg/kg, confirmation sampling will be conducted across the bottom of the excavation to verify that all sediments with PCB concentrations of greater than 50 mg/kg have been removed. Again, field test kits may initially be used to support the sediment removal process on a real-time basis, but the vertical extent of excavation will be confirmed with the collection of grab sediment samples on a 25-foot grid across the excavation bottom and laboratory analysis of the samples for PCBs by EPA Method 8082. If any bottom samples exceed a PCB concentration of 50 mg/kg, additional sediment removal will be conducted in any such locations, followed by additional confirmation sampling at the same spacing until the final bottom confirmation samples all have PCB concentrations less than 50 mg/kg. All sample collection, preservation, chain-of-custody and other procedures for the samples submitted to the analytical laboratory will be in accordance with the approved Quality Assurance Project Plan (QAPP) for the site.



### 3.3.7. Handling and Dewatering of Excavated Sediments

Excavated sediments will be directly loaded onto, or transported to, an on-site dewatering pad located adjacent to the canal for dewatering, and confirmation sampling in the case of the sediments excavated from the PCB-contaminated area, prior to subsequent loading, transportation and final disposal. The dewatering process is currently anticipated to include the following processes, as generally depicted on the attached Drawings (Sheet 5), although the actual process may vary depending on the sediment conditions encountered during the work, contractor input, and other factors:

- **Dewatering/Drying:** The general dewatering/drying process for all of the excavated sediments will consist of spreading the sediments into separate windrows across the dewatering pads to facilitate gravity drainage and evaporation. As warranted by field conditions, the selected drying agents (i.e., LKD and potentially dried and ground up phragmites) will be mixed into the sediments to support the drying process, and the windrows will be periodically mixed in-place with an excavator, specialized mixing equipment, or other equipment to maximize the rate of drainage and solar drying. During periods of inactivity or wet weather, the piles will be covered with weighted plastic tarps to help keep them dry. Fluids drained from the sediments will be collected and managed in general accordance with the procedures discussed below, with separate processes applicable to the sediments from the PCB-contaminated area versus the sediments from the other sections of the canal. The dewatering process (i.e., solar drying, gravity drainage, and/or reagent addition) will continue until the sediments no longer have any free-draining liquids as determined by the paint filter test (i.e., SW-846 Method 9095B). The paint filter test will be conducted in the field at a minimum frequency of 1 sample (representing a 10-part composite) for every 500 cubic yards of material; additional testing of materials will be conducted if heterogeneous conditions are encountered and potential free liquids are suspected within any portion of the dewatered sediments prior to loading for transportation and disposal. The most appropriate combination of gravity drainage and reagent addition, as well as the most appropriate quantity of reagent addition, will likely vary along the canal and throughout the project (e.g., based on variable weather), but has generally been estimated for sizing of the dewatering pads, scheduling estimates, and preliminary reagent volume estimates as shown in the calculations presented in Appendix B.
- **Management of Fluids:** Fluids drained from the sediments from non-PCB areas will generally be directed back to the canal, while fluids drained from the sediments from the PCB-contaminated section will be directed to sumps or small berms located at the downslope edge of the dewatering pad(s) for collection and treatment before being discharged back to the canal for final treatment through the HCWWTP. For the sediments removed from the PCB-contaminated area, the fluids will be collected into

20,000-gallon (approximately) portable frac tanks with baffles or weirs for flow equalization, settling of solids, and separation of free oils, followed by passing through a particulate filter and granular activated carbon (GAC) treatment system (currently planned to consist of two 2,000-pound liquid-phase carbon vessels connected in series) for PCB removal prior to being discharged back to the canal at a downstream location for final treatment through the HCWWTP. The goal for treated fluids discharged back to the canal from the PCB-impacted area will be Non-Detect for total PCBs by USEPA Method 8082. Following any oil separation, a sample of the water from the frac tank will be collected and analyzed for total organic carbon (TOC) and total PCBs for use in estimating the treatment capacity of the GAC vessels. A water sample will subsequently be collected from a sample port between the primary and secondary GAC vessels for analysis of total PCBs by USEPA Method 8082 at approximately 50%, 80% and 100% of the estimated lifespan of the primary GAC vessel. As soon as any PCBs are detected in the sample between the primary and secondary GAC vessels, the secondary GAC vessel will become the primary vessel (i.e., first vessel in series), and the old primary vessel will be replaced with fresh GAC and will become the new secondary vessel; this process will be repeated as necessary until the PCB-treatment activities are completed. Any solids collected from the holding tank(s) will be removed, dewatered, and combined with the other sediments for subsequent sampling and disposal. The fluids management process for sediments removed from the PCB-contaminated area is summarized on Figure 4. For the sediments removed from the non-PCB-contaminated areas, the fluids will be visually inspected for the presence of free-phase oils. If significant free-phase oils are detected, the water will be treated through oil-absorbent booms, skimmer, frac tank with weir, or similar method prior to being discharged back to the canal, and the oily wastes will be properly containerized and removed from the site for recycling or disposal; the absence of a visible oily sheen will be the performance goal for treated fluids from the non-PCB areas being discharged back to the canal. If significant free-phase oils are not observed, the drained fluids will be discharged back to the canal directly without treatment.

### 3.3.8. Waste Characterization and Disposal

After field testing indicates that the sediments no longer have any free-draining liquids per the paint filter test, the sediments will be ready for removal from the dewatering pads and subsequent loading, transportation and disposal.

For the sediments removed from the PCB-contaminated area, one representative ten-part composite sample (separate, approximately equal volume aliquots will be collected randomly and homogenized) will be collected for every 500 cubic yards of material and submitted to an analytical testing laboratory for analysis of PCBs by EPA Method 8082 (all sample collection, preservation, chain-of-custody and other procedures for the samples submitted to the analytical laboratory will be in accordance with the approved QAPP for the site). Materials that are



determined to have PCB concentrations equal to or greater than 50 mg/kg will be shipped off-site by a licensed waste hauler in accordance with the applicable regulations for disposal at a TSCA-permitted landfill. Materials excavated from the PCB-contaminated areas that are determined by laboratory analysis to have PCB concentrations less than 50 mg/kg will be directed to the on-site landfill (Greys). No soils or sediments removed from the PCB-containing area of the TMC will be disposed of at Greys Landfill without prior approval from MDE.

Sediments removed from the non-PCB-contaminated areas are currently planned for disposal at the on-site Greys Landfill. However, to help ensure that sediments with PCB concentrations of equal to or greater than 50 mg/kg are not placed into the on-site landfill, a ten-part composite sample from at least every 1,000 cubic yards of these materials (i.e., one aliquot from each 100 cubic yard [or smaller] batch) will be collected and analyzed for PCBs by EPA Method 8082 prior to loading and transportation. If PCB concentrations equal to or greater than 50 mg/kg are detected, additional sampling will be conducted to help narrow down the volume of sediments with PCB concentrations equal to or greater than 50 mg/kg. Sediments confirmed to have PCB concentrations equal to or greater than 50 mg/kg will be loaded and shipped off-site by a licensed waste hauler in accordance with the applicable regulations for disposal at a TSCA-permitted landfill. Sediments confirmed to have PCB concentrations less than 50 mg/kg will be loaded and transported to the on-site Greys Landfill. If required by the MDE, additional TCLP testing will be conducted prior to transportation to Greys Landfill. Based on any such additional testing, any materials that exceed the TCLP hazardous waste concentration thresholds will be sent off-site for disposal at a RCRA-permitted landfill; no hazardous waste will be disposed of into Greys Landfill.

All loading and transportation activities will be conducted in a manner to prevent the spill or release of impacted sediments to the environment, and to prevent accelerated soil erosion. Materials approved for placement in the on-site Greys Landfill will be loaded into secure haul trucks for transportation to the landfill. Materials scheduled for off-site disposal will be loaded into gondola rail cars or intermodal containers provided by the waste hauling company. On-site haul roads will be periodically inspected and maintained as necessary to prevent sediment tracking to other areas (e.g., by periodic sweeping) and excessive rutting, erosion or other roadway degradation. The planned staging and loading areas and haul route from the canal to the landfill is shown on the attached Sheet 3. Dust will be controlled as required along the haul roads by water spraying with a water truck. The quantities of all materials that are sent off-site for disposal or transported to the on-site landfill for disposal will be recorded.

### 3.3.9. On-Site Waste Disposal

Sediments that are approved for on-site disposal will be transported to the on-site Greys Landfill for placement, grading, and compaction. The sediments will be dumped out, spread, and compacted within a relatively flat section of the landfill as generally shown on the attached Sheet 4. Sufficient disposal capacity exists in the landfill based on a comparison of the available

landfill space (approximately 150,000 cubic yards per the most recent capacity evaluation for the second quarter 2017) to the estimated volume of sediments to be disposed (approximately 70,000 cubic yards as shown in the Appendix B calculations). As shown on Sheet 4, a containment berm has been constructed at the top of Greys Landfill to provide a cell for the management of the excavated and dewatered sediments; additional information regarding this berm is presented as Appendix D of this Work Plan.

The materials will generally be placed in working lifts of up to 2 feet thick, and graded and compacted with a bulldozer to reduce volume and increase strength. Compaction efforts will be continued until the materials are firm and stable, and when additional passes of the compaction equipment do not result in any notable additional volume reduction. Depending on the moisture content and consistency of the materials, reagent addition may be conducted following placement into the landfill to support effective spreading and compaction of the materials. The working surface will be periodically inspected and surveyed to ensure proper grading and drainage in accordance with the provisions of the Greys Landfill Facility Operations Manual (February 2015). Because the materials are essentially soil or soil-like, periodic daily cover, which is required to be placed above construction and demolition debris, will not be placed above the sediments, although intermediate and final cover will be placed in accordance with the landfill operations manual following completion of the sediment placement activities.

Slope stability modeling has been conducted for the landfill based on the anticipated total sediment thickness (i.e., approximately 12 feet thick based on current volume estimates and the planned placement area) and total unit weight (up to approximately 125 pcf). The results of this modeling (presented at the end of Appendix B) indicate acceptable factors of safety for all cases evaluated even when assuming a highly conservative internal friction angle of only 10 degrees, so additional strength testing will not be required to confirm stability of the landfill.

### **3.3.10. Channel Restoration and Capping**

Following sediment excavation within each of the active work areas, and prior to the removal and relocation of the coffer dams and pumping systems, the residual sediments and fill materials will be covered with a 2-foot thick (minimum) cap to prevent future direct contact exposure risks and protect water quality in the canal discharging to Bear Creek in compliance with stormwater permit conditions, and to provide a non-erosive canal lining that will facilitate future stormwater conveyance. Additional aggregate fill will be placed in the PCB-contaminated sediment removal area as necessary to achieve the desired subgrade elevations prior to cap placement. As generally depicted on Sheets 5 and 6 of the Drawings, the cap is planned to consist of a geotextile filter fabric overlain by finely graded aggregate and rip-rap lining up to the final canal grade. The proposed rip-rap lining has been sized in accordance with applicable Maryland procedures for erosion and sediment control to prevent scour and provide an erosion resistant surface based on the anticipated maximum flow velocities associated with projected flow rates in the canal, including the outfall discharge locations. Based on the calculated flow velocities, the

required minimum rip-rap lining ranges from Class 0 (placed at 12” thick) to Class I (placed at 18” thick), and the project has been conservatively designed to use Class I rip-rap along the entire canal; the rip-rap sizing calculations are summarized in Appendix B.

### 3.3.11. Equipment Decontamination and Removal

Following completion of the work within each area, equipment will be properly decontaminated to prevent the tracking of contamination to other areas of the site or off-site areas. Decontamination will generally involve dry brushing to remove any dirt and loose sediments, followed by steam-cleaning or high pressure water washing to remove any residual solids. Decontamination water will generally be directed into the sumps of the dewatering pads where practical, or directly into the canal for subsequent treatment through the HCWWTP. Collected solids will be returned to the canal and placed below the cap where possible, or will be managed in a manner consistent with the excavated sediments.

### 3.3.12. Health and Safety Measures

A site-specific HASP will be developed to present the minimum requirements for worker health and safety protection for the project. All contractors working on the Site will be required to prepare their own HASP that provides a level of protection at least as much as that provided by the site-specific HASP, or on-site contractors may elect to adopt the HASP provided. The HASP for this project will be a minor modification to an earlier site-specific HASP developed for the site. All workers conducting the TMC maintenance cleanup activities will be required to be OSHA-certified for hazardous waste operations.

### 3.3.13. Dust Control

Overall dust control methods shall include:

- Periodic site wetting and dust suppression of active work areas where dry materials are present. Over-spraying of water shall be avoided in order to prevent erosion or sediment control complications.
- Reduced vehicle speeds.
- Minimizing drop heights.
- Covering dry stockpiles with tarps.
- Stabilizing exposed surfaces as soon as possible.

General construction operations, including removal of existing structures and utilities, sediment excavation and transport, and cap construction activities will be performed at the Site. To limit worker exposure to contaminants borne on dust and windblown particulates, dust control measures will be implemented, if warranted, when the above activities are performed in areas with impacted materials. The action level proposed for the purpose of determining the need for dust suppression techniques (e.g., watering and/or misting) and/or continuous monitoring during

the response and development activities on Site will be 3.0 mg/m<sup>3</sup>. The lowest of the site-specific dust action levels, OSHA PELs, and ACGIH TLV was selected as the proposed action level.

If visible dust is generated in the breathing zone, air monitoring will be implemented as follows:

- at the start of intrusive activities;
- periodically during intrusive activities (15-minute intervals);
- when contaminants other than those previously identified are being handled;
- when a different type of operation is initiated or conditions change;
- if personnel are working in areas with obvious particulate contamination; and
- if a sufficient reasonable interval has passed so that exposures may have significantly changed.

Air monitoring will be performed using a ThermoElectron Corporation Personal Data RAM 1000AN dust monitor or equivalent real-time air monitoring device. If the action level (3.0 mg/m<sup>3</sup>) is exceeded as a result of conditions occurring at the Site, operations will be stopped and dust suppression implemented. The background dust concentration will be utilized to evaluate whether Site activities are the source of the action level exceedance. Background concentrations will be based on measurements over a minimum of a one hour period at the upwind Site boundary. This upwind data will be used to calculate a time weighted average background dust concentration. The background dust concentration may need to be recalculated periodically during the work day, based on changed upwind conditions. Operations may be resumed once monitoring indicates that dust concentrations are below the action level.

As applicable, air monitoring will be conducted during response and development implementation activities in the immediate work zones and surrounding areas to assess levels of exposure to Site workers, establish that the work zone designations are valid, and verify that respiratory protection being worn by personnel, if needed, is adequate. Concurrent with the work zone air monitoring, perimeter air monitoring will also be performed to ensure contaminants are not migrating off-site. Perimeter monitoring will include monitoring along the perimeter of the Site, including both the downwind and upwind portions of the Site. The concentration measured in the downwind portion of the Site shall not exceed the concentration in the upwind portion. If exceedances attributable to Site conditions are identified downwind for more than five minutes, dust control measures and additional monitoring will be implemented. The dust suppression measures may include wetting or misting through use of a hose connected to an available water supply or a water truck stationed on Site.

Dust control measures will be implemented as described above to address dust generated as a result of construction and response activities conducted on Site. However, based on the nature of the area and/or on-going activities surrounding the Site, it is possible that windblown particulates may come from surrounding areas. As discussed above, the dust concentration in the upwind

portion of the Site will be considered when monitoring dust levels in the work zone. A pre-construction meeting will be held to discuss the potential of windblown particulates from other activities impacting the air monitoring required for this response plan. Site contact information will be provided to address the possibility of upwind dust impacts.

### 3.3.14. Project Oversight and Documentation

Construction Oversight by a qualified Environmental Professional (EP) will be conducted to ensure and document that the project is completed as planned and that appropriate environmental and safety protocols are followed. The following information will be collected during the course of the work:

- daily observations of construction activities including:
  - demolition activities conducted;
  - oil removal volumes;
  - volume of sediments excavated;
  - volume of LKD and/or phragmites added to excavated sediments;
  - sediment drying and management activities on dewatering pad;
  - volume of material removed from the dewatering pads;
  - volume of material transported to Greys Landfill;
  - volume and destination of material transported off-site for disposal;
  - extent of canal lining and cap construction completed;
  - water management and treatment activities; and
  - sediment delineation and waste characterization sampling;
- analytical results for all solids and fluids that are sampled;
- measurements of cap thickness;
- waste manifests for materials shipped off-site for disposal; and
- photographs of the sediment excavation and cap construction work.

Progress reports will be submitted to the MDE and EPA during and following the completion of the work as summarized below:

- **Weekly:** after the start of the work, weekly progress reports will be submitted via email to summarize the major work activities from the prior week and the major activities planned for the following week and month;
- **Monthly:** beginning two months after the start of the sediment excavation work, monthly progress reports will be submitted to present the volume of sediments excavated, the volume of materials transported to Greys Landfill and off-site, and any other notable observations or results from the reporting period; and
- **Final:** a final report will be submitted within 60 days following the completion of the work to document that the work was completed in accordance with the approved Work Plan; it will include analytical results, disposal records, selected photographs, etc.

## **4.0 PERMITS, NOTIFICATIONS AND CONTINGENCIES**

The participant and their contractors will comply with all local, state and federal laws and regulations by obtaining any necessary approvals and permits to conduct the activities contained herein.

A Joint Permit Application (JPA) was prepared and submitted to the MDE Water Management Administration to obtain approval for the proposed activities described in this Work Plan. The JPA was approved by the MDE, and a copy of the Authorization to Proceed is provided as Appendix C of this Work Plan. A copy of the authorization from the US Army Corps of Engineers is also included in Appendix C.

In addition to MDE approval of this Work Plan, approval will be obtained from the Baltimore County Soil Conservation District prior to initiation of land disturbance activities for this project. This Work Plan and the attached Drawings are being submitted to the County to facilitate their review and approval. Supporting letters from the MDE (regarding no additional erosion and sediment control measures needed) and Baltimore County (regarding stormwater management variance) are provided in Appendix C.

Contingency measures will include the following:

1. the MDE will be notified immediately of any previously undiscovered contamination, previously undiscovered storage tanks and other oil-related issues, and citations from regulatory entities related to health and safety practices; and
2. any significant change to the implementation schedule will be noted in the progress reports to MDE.

## 5.0 IMPLEMENTATION SCHEDULE

The currently anticipated project implementation schedule is shown below. Once the work is started, it will be conducted continuously throughout the year, weather permitting. This schedule is subject to change based on actual dewatering rates, weather conditions, contractor rate of progress, agency approvals, and other factors. Progress reports will be submitted to MDE and EPA periodically (see Section 3.3.14 of this Work Plan) to document the progress of the work and any revisions to the project schedule.

<b><u>Task</u></b>	<b><u>Projected Completion Date</u></b>
Anticipated Work Plan Approval	December 21, 2017
Equipment Mobilization and Site Staging	January 1, 2018
Vegetation Removal and Drying (first section)	January 1, 2018
Sediment Excavation and Capping	January 30, 2019

## 6.0 REFERENCES

ARM Group, Inc. (2016). *Quality Assurance Project Plan: Sparrows Point Terminal Site*.  
Revision 3. April 5<sup>th</sup>, 2016.

EnviroAnalytics Group (EAG), 2014. *Site Conceptual Cleanup Plan*. August 2014.



---

---

## **FIGURES**

---

---





Image courtesy of USGS Earthstar Geographics SIO © 2016 Microsoft Corporation

  
 ARM Group Inc.
   
 Earth Resource Engineers
   
 and Consultants

0 375 750 1,500
   
 Feet

- Site Boundary
- Private Property
- Area A Boundaries
- Area B Boundaries

**Tradepoint Atlantic**  
**Area A and Area B Parcels**  
 August 1, 2016

EnviroAnalytics Group  
 Area A: Project 150298M  
 Area B: Project 150300M

Tradepoint Atlantic  
 Baltimore County, MD

**Figure**  
**1**



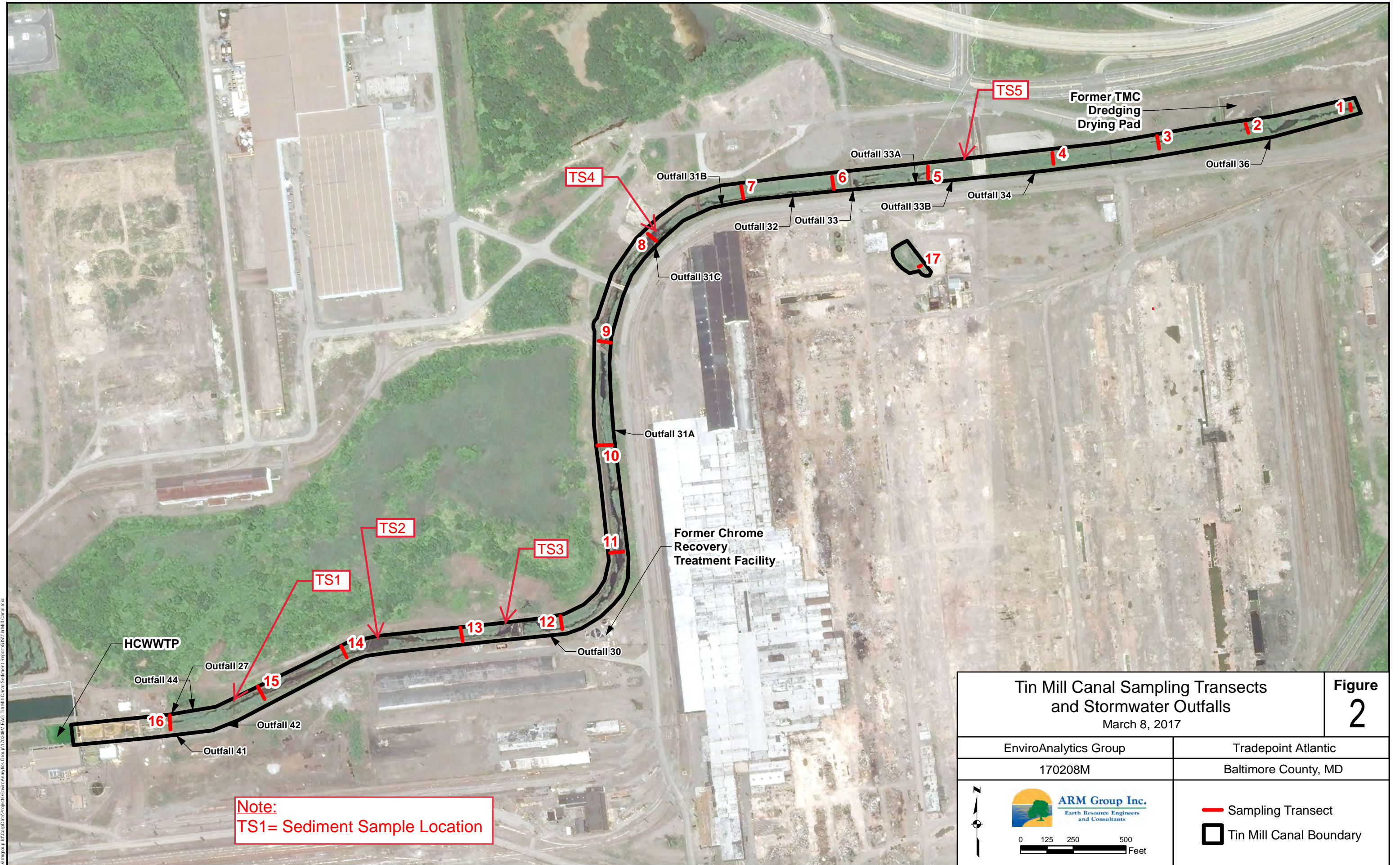



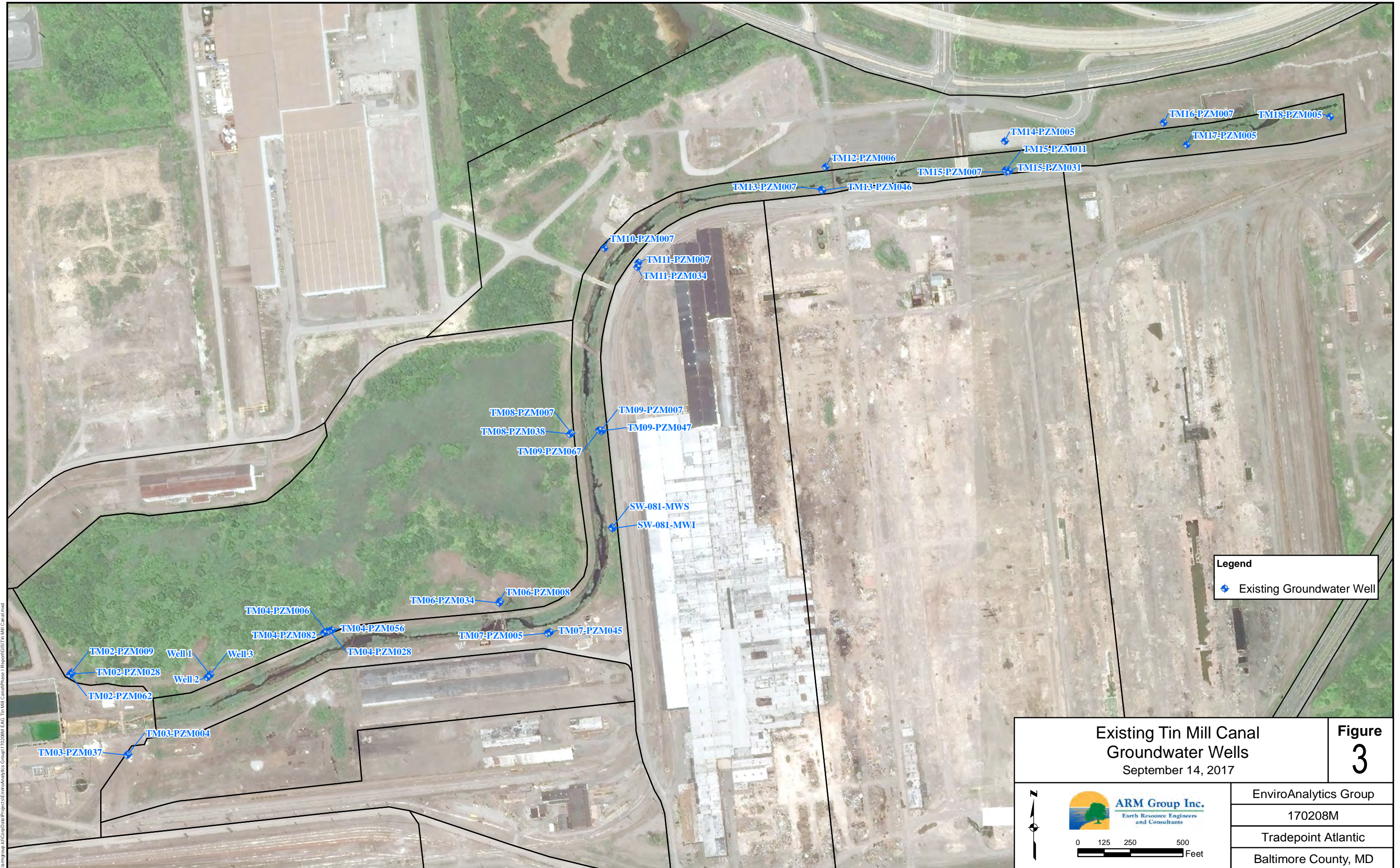



Existing Tin Mill Canal  
Groundwater Wells  
September 14, 2017

Figure  
3



**ARM Group Inc.**  
 Earth Resource Engineers  
 and Consultants

0 125 250 500  
 Feet

EnviroAnalytics Group
170208M
Tradeport Atlantic
Baltimore County, MD

\imggroup\del\CompData\Project\EnviroAnalytics Group\170208M\_EAG\_Tin Mill Canal\Phase 1\Report\GIS\Tin Mill Canal.mxd



**FIGURE 4**  
**PROCESS DIAGRAM: TIN MILL CANAL SEDIMENT REMOVAL PLAN**  
**SOLIDS AND LIQUIDS HANDLING FOR PCB-CONTAMINATED AREA**

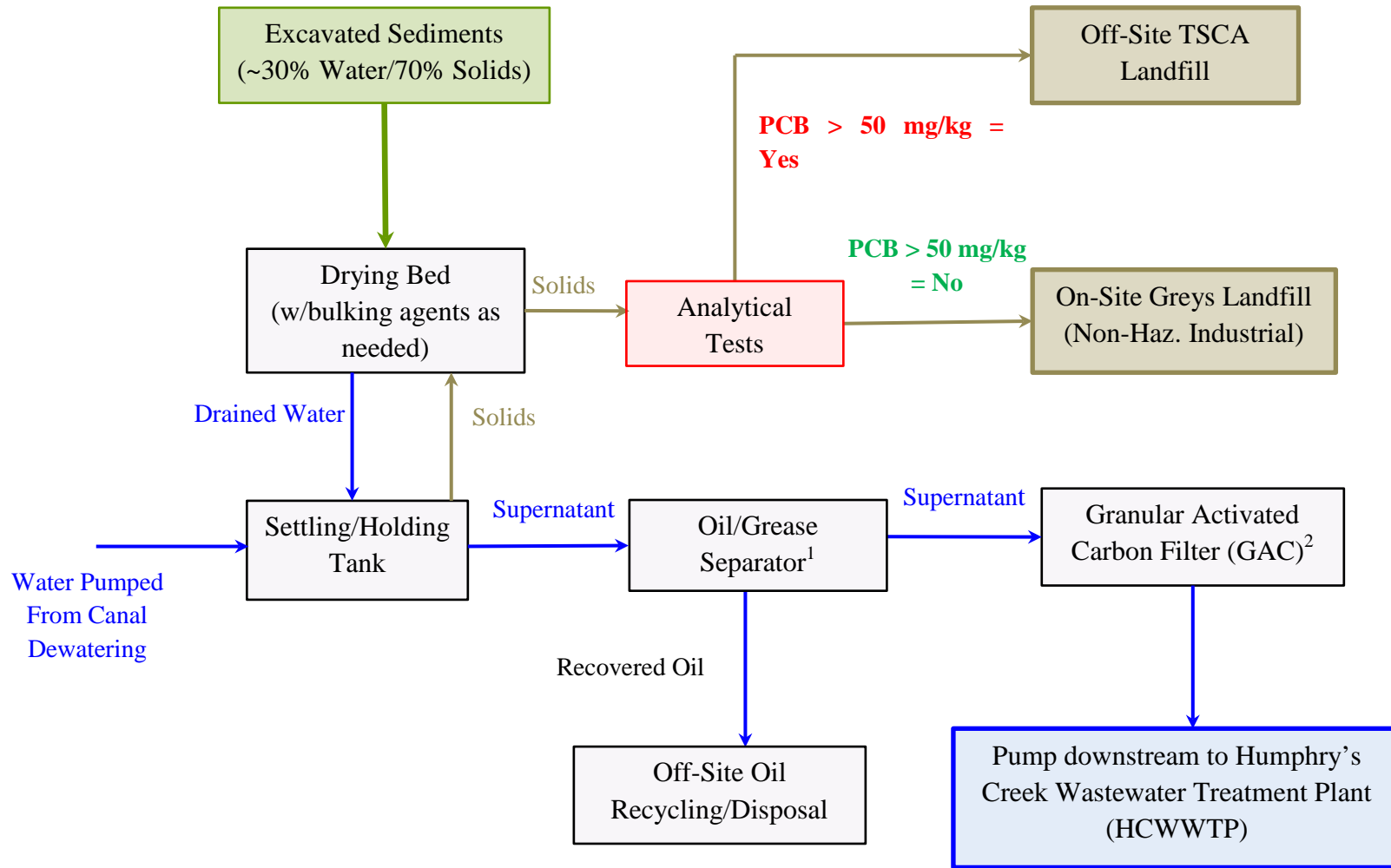

**Notes:**

<sup>1</sup> Planned to consist of a baffle or weir within the holding (frac) tank.

<sup>2</sup> Planned to consist of two 2,000 pound liquid GAC vessels in series, with a bag or other particulate filter prior to the GAC vessels

---

---

# **DRAWINGS**

---

---

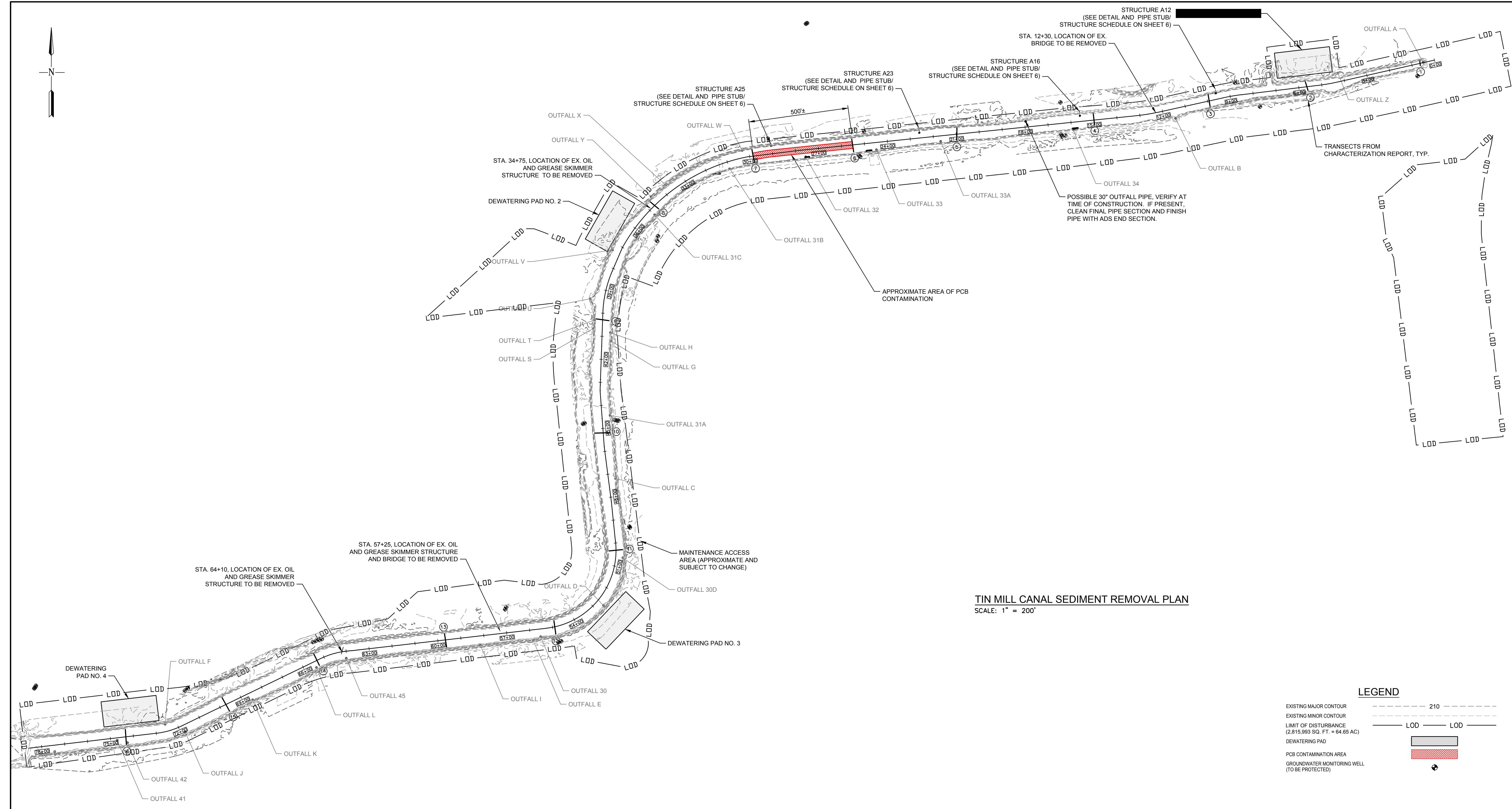
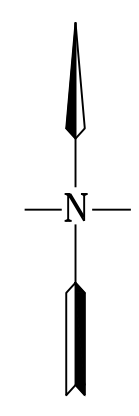

TIN MILL CANAL SEDIMENT REMOVAL PLAN  
SCALE: 1" = 200'

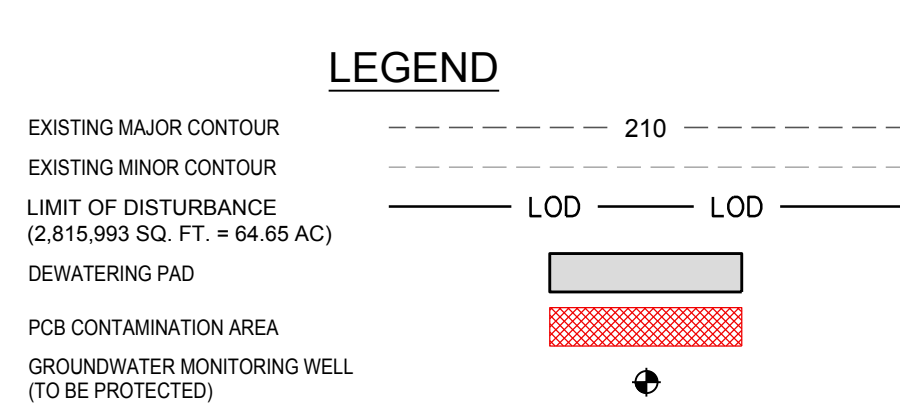

**GENERAL NOTES:**

1. TOPOGRAPHIC MAPPING IS FROM AERIAL SURVEY CONDUCTED BY CME ENGINEERING OF SOMERSET, PENNSYLVANIA ON MARCH 30, 2017.
2. DEWATERING PAD NO. 1 IS EXISTING. CONTRACTOR SHALL VERIFY THE INTEGRITY OF THE PAVED SURFACE PRIOR TO STAGING EXCAVATED MATERIAL.
3. DIMENSIONS AND LOCATIONS OF DEWATERING PADS NOS. 2 THRU 4 ARE APPROXIMATE AND MAY BE FIELD-ADJUSTED TO MEET SITE OR OPERATIONAL REQUIREMENTS. ADDITIONAL DEWATERING PADS MAY ALSO BE CONSTRUCTED ALONG THE CANAL AS APPROPRIATE AND AS DIRECTED BY THE ENGINEER TO BEST SUPPORT THE WORK ACTIVITIES.
4. WINDROW SPACING IS ASSUMED AND SHALL BE ADJUSTED BY THE CONTRACTOR AS NEEDED TO SUIT ACTUAL EQUIPMENT USED AND THE CONDITION OF EXCAVATED MATERIAL. WINDROWS SHALL BE TURNED DAILY, OR MORE FREQUENTLY, DURING DRY AND SUITABLE WEATHER. ESTIMATED TIME FOR DRYING IS ONE (1) TO TWO (2) WEEKS, DEPENDING ON WEATHER CONDITIONS. PILES SHALL BE COVERED WITH PLASTIC PRIOR TO AND DURING ANY RAINFALL EVENTS. DRYING AGENTS SHALL BE ADDED AND MIXED INTO THE EXCAVATED SEDIMENTS AS DIRECTED BY THE ENGINEER, AND/OR A PORTABLE PUG MILL MAY BE UTILIZED FOR MIXING REAGENTS INTO THE EXCAVATED SEDIMENTS.
5. CONFIRM THE REMOVAL OF STRUCTURES WITH THE OWNER, PRIOR TO DEMOLITION. OIL-ABSORBENT BOOMS AND/OR OTHER MEASURES SHALL BE PLACED DOWNSTREAM OF THE EXISTING OIL-REMOVAL STRUCTURES PRIOR TO THEIR REMOVAL.
6. THE MAINTENANCE ACCESS AREA DRAINS TO THE CANAL, SO ADDITIONAL PERIMETER CONTROLS ARE NOT REQUIRED.
7. NO SOILS OR SEDIMENTS REMOVED FROM THE PCB-CONTAINING AREA OF THE TMC MAY BE DISPOSED OF AT GREYS LANDFILL WITHOUT PRIOR APPROVAL FROM MDE. ALSO, NO HAZARDOUS WASTE SHALL BE DISPOSED OF IN GREYS LANDFILL; ADDITIONAL TCLP TESTING SHALL BE CONDUCTED IF REQUIRED BY MDE PRIOR TO DISPOSAL.

**SEQUENCE OF MAINTENANCE ACTIVITIES:**

1. ESTABLISH STAGING AREAS AND REMOVE VEGETATION PRIOR TO SEDIMENT EXCAVATION. CONDUCT SEDIMENT EXCAVATION WORK IN SECTIONS WORKING FROM UPSTREAM TO DOWNSTREAM.
2. CONDUCT SEDIMENT SET UP BYPASS PUMPING SYSTEM. BASE FLOW IS ESTIMATED TO BE 3000 GALLONS PER MINUTE ALONG THE ENTIRE CANAL.
3. ESTABLISH DEWATERING ZONES IN UP TO APPROXIMATELY 600 LINEAR FOOT SECTIONS, STARTING AT THE UPSTREAM END OF THE TIN MILL CANAL. INSTALL COFFER DAMS AT THE UPSTREAM AND DOWNSTREAM ENDS OF THE SECTION.
4. PUMPS SHALL BE USED AS NECESSARY UPSLOPE AND WITHIN THE ACTIVE WORK ZONE AS NECESSARY TO CONTROL THE INTRUSION OF SURFACE WATER AND GROUNDWATER BASE FLOW.
5. SEQUENCE THE FLUSHING OF STORMWATER OUTFALL PIPING SUCH THAT SEDIMENT OR DEBRIS IS NOT DEPOSITED IN SECTIONS OF THE TIN MILL CANAL THAT HAVE ALREADY BEEN EXCAVATED AND RESTORED TO GRADE.
6. EXCAVATE SEDIMENT FROM THE DEWATERED SECTIONS TO A DEPTH OF AT LEAST 2- FEET BELOW THE PLANNED FINAL CANAL GRADE. DEEPER EXCAVATION IS REQUIRED WITHIN THE AREA OF PCB CONTAMINATION.
7. INSTALL CAP AND STABILIZE WORK AREAS AS SOON AS POSSIBLE FOLLOWING SEDIMENT REMOVAL.
8. SITE DEVELOPMENT WORK BY OTHERS SHALL NOT BE CONDUCTED WITHIN THE DESIGNATED MAINTENANCE ACCESS AREA (I.E., LOD FOR THIS PROJECT) UNTIL THE SEDIMENT REMOVAL AND CAPPING WORK IS COMPLETED WITHIN THAT SECTION OF CANAL.

**STREAM CLOSURE NOTE:**

NO CONSTRUCTION IS PERMITTED IN CLASS I WATERS FROM MARCH 1 THROUGH JUNE 15. NO WORK SHALL BE CONDUCTED IN THE TIN MILL CANAL DURING THAT PERIOD UNLESS OTHERWISE APPROVED BY MDE (A WAIVER REQUEST HAS BEEN SUBMITTED TO THE MDE).

**PROFESSIONAL CERTIFICATION**  
I hereby certify that these documents were prepared or approved by me, and that I am a duly licensed professional engineer under the laws of the State Of Maryland.  
License No. 17290  
Expiration Date 03-22-2019



**ARM Group Inc.**  
Earth Resource Engineers and Consultants  
www.armgroup.net

Designed	JBM	1" = 200'
Checked	TNP	Date 11/29/2017
Drawn	JMA	Project No. 170208M

2	Addressed comments from Baltimore County and MDE	11/29/17	ARM	By
1	Property Detail	11/2/17	ARM	Date

**TIN MILL CANAL REMOVAL PLAN**  
SPARROWS POINT  
BALTIMORE COUNTY, MARYLAND

Sheet **1**

SEAL



**LEGEND**

- EXISTING MAJOR CONTOUR  210
- EXISTING MINOR CONTOUR
- CONSTRUCTION ACCESS
- DESIGN CHANNEL BOTTOM
- TOP OF BANK AT 2:1 SLOPE

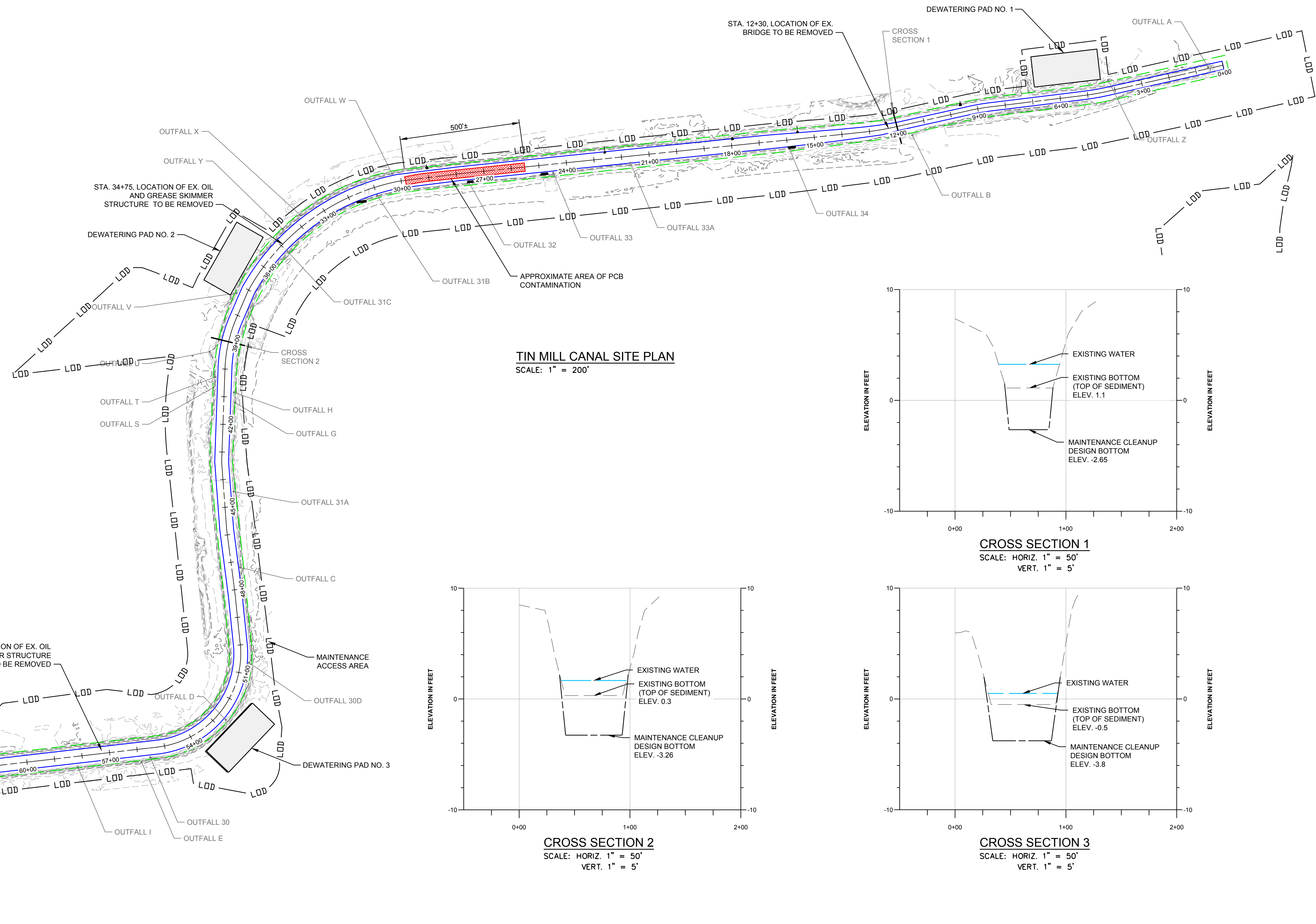
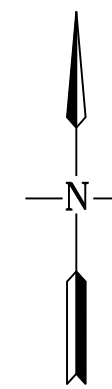

**TIN MILL CANAL SITE PLAN**  
SCALE: 1" = 200'

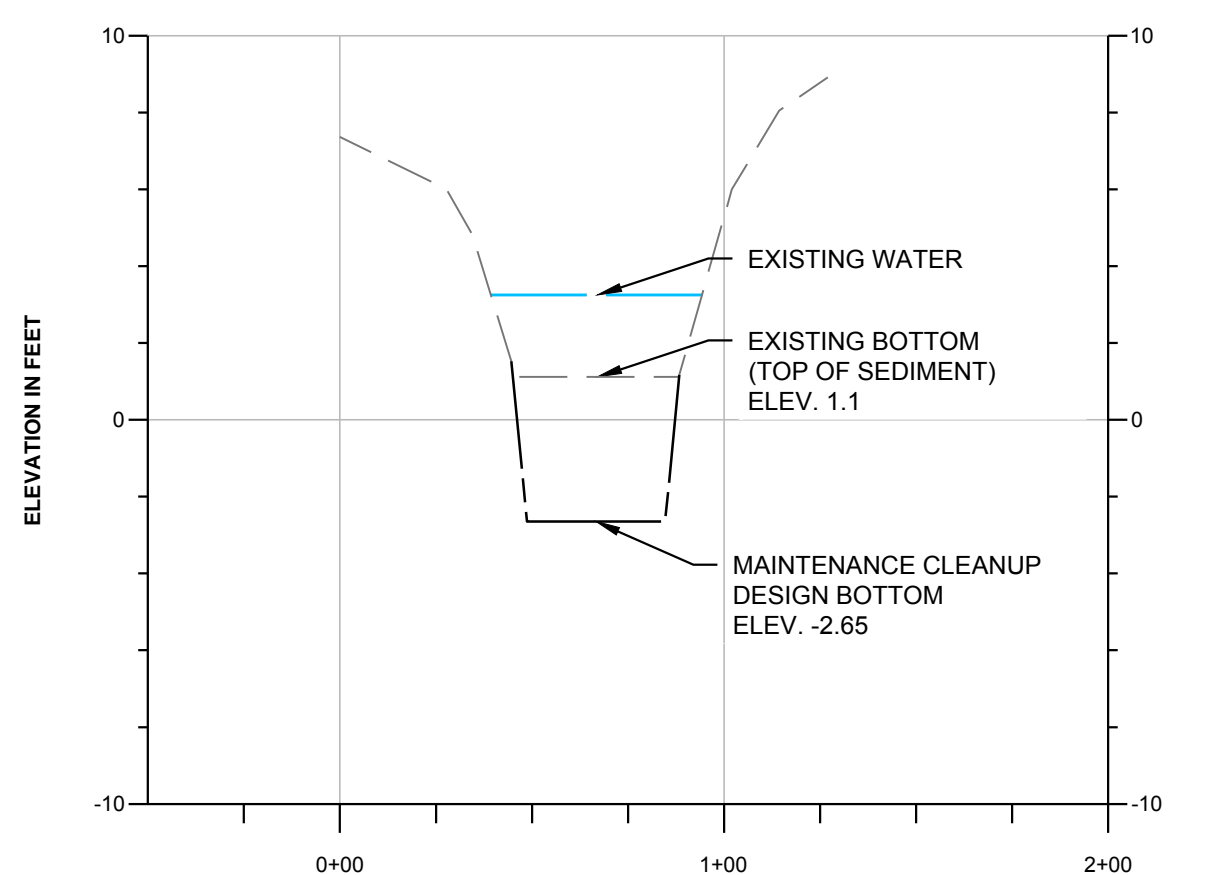

**CROSS SECTION 1**  
SCALE: HORIZ. 1" = 50'  
VERT. 1" = 5'

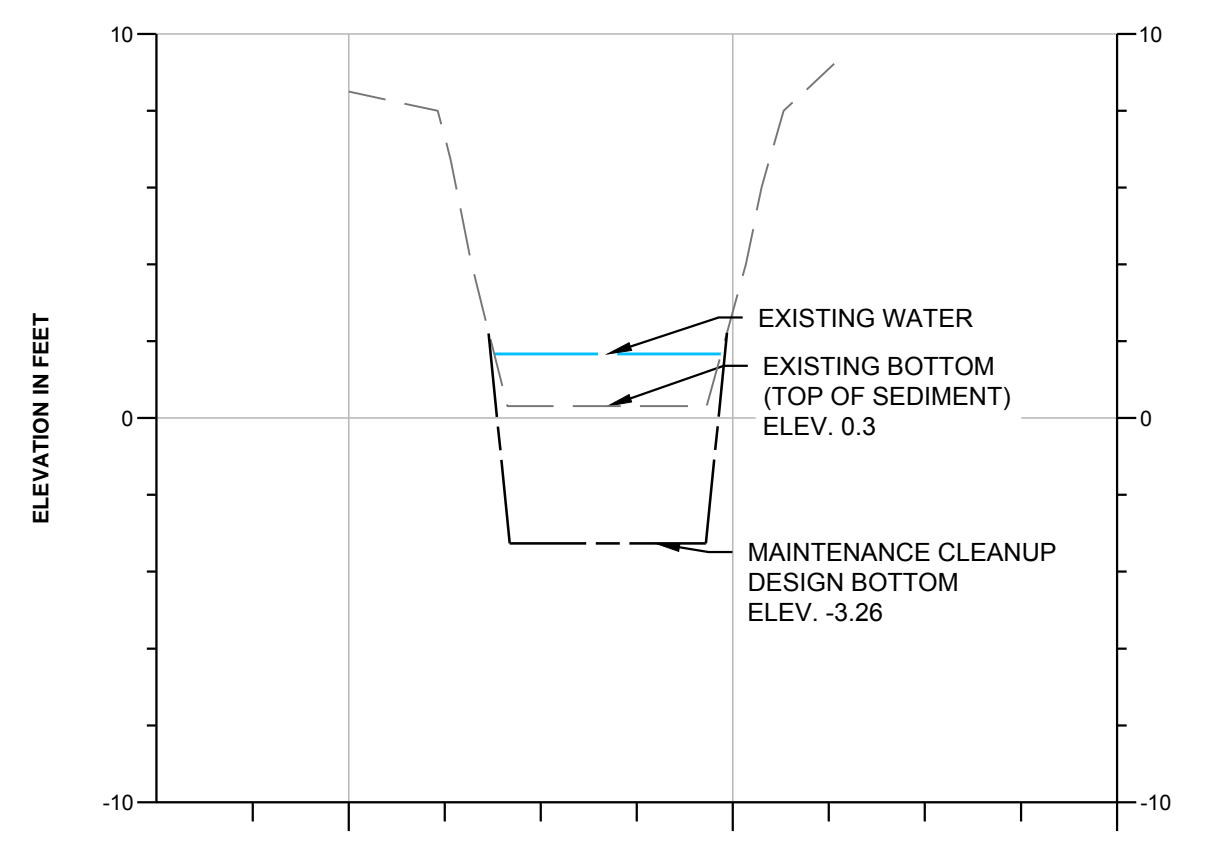

**CROSS SECTION 2**  
SCALE: HORIZ. 1" = 50'  
VERT. 1" = 5'

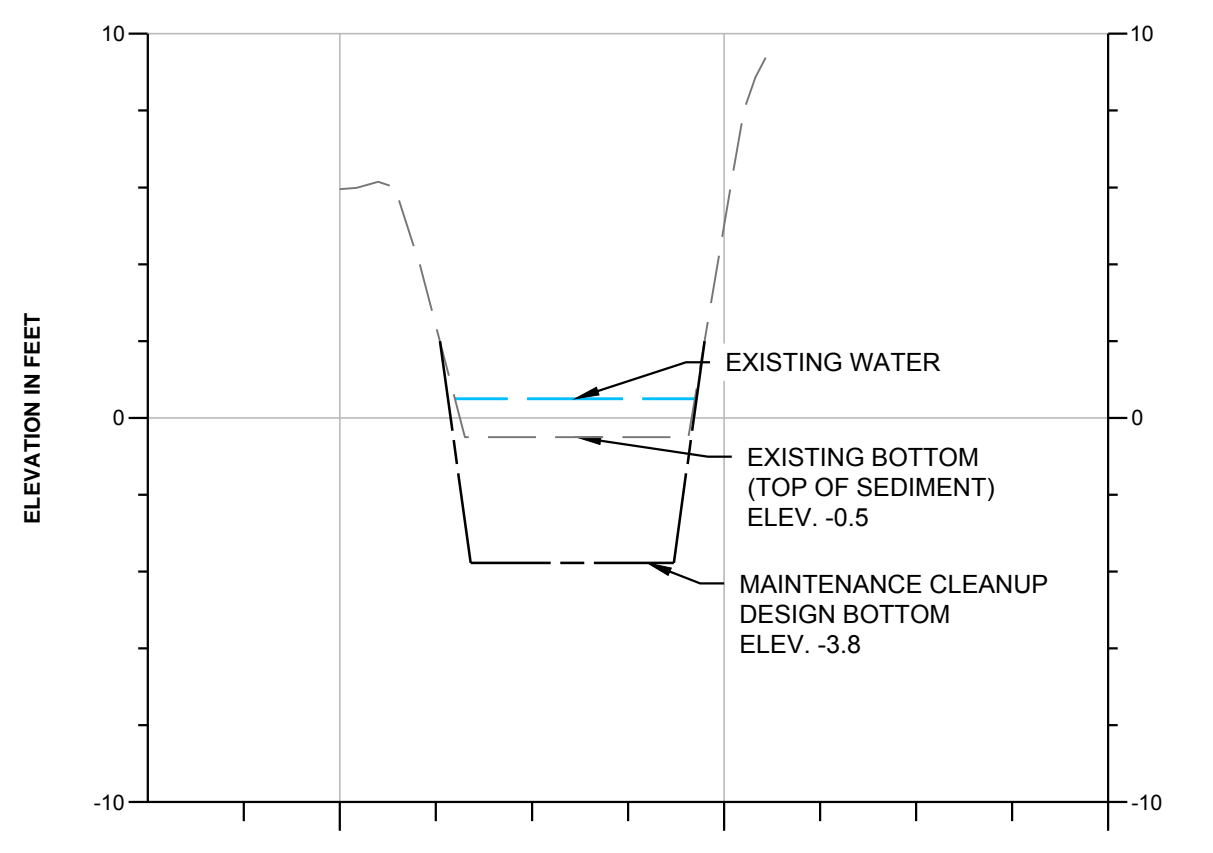

**CROSS SECTION 3**  
SCALE: HORIZ. 1" = 50'  
VERT. 1" = 5'

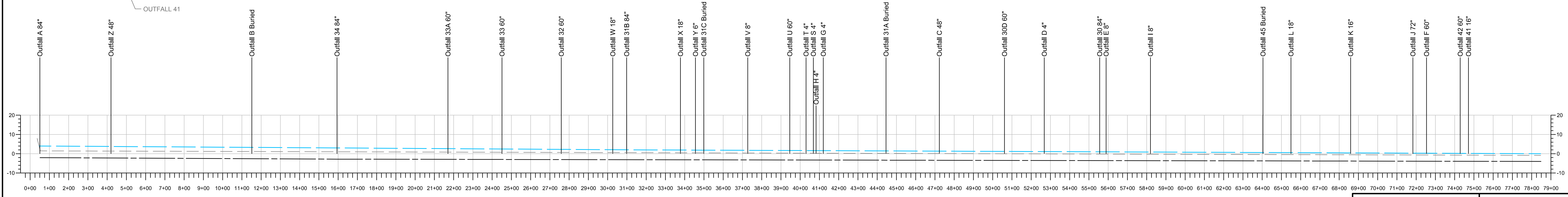

**TIN MILL CANAL PROFILE**  
SCALE: HORIZ. 1" = 250'  
VERT. 1" = 2.5'

**PROFILE LEGEND**

- EXISTING WATER ELEVATION  
BASED ON UAV SURVEY DATA COLLECTED 5-30-17 BY CME ENGINEERING
- EXISTING BOTTOM ELEVATION (TOP OF SEDIMENT)  
APPROXIMATED TOP OF SEDIMENT ELEVATION BASED ON BURIAL DEPTHS FROM TABLE 1
- MAINTENANCE CLEANUP DESIGN BOTTOM ELEVATION  
BASED ON LOWEST OUTFALL INVERTS FROM DATA COLLECTED 8-28-17 BY TRAD ENGINEERING

**PROFESSIONAL CERTIFICATION**

I hereby certify that these documents were prepared or approved by me, and that I am a duly licensed professional engineer under the laws of the State of Maryland.  
License No. 17290  
Expiration Date 03-22-2019



**PROFILE AND CROSS SECTIONS**

SPARROWS POINT  
BALTIMORE COUNTY, MARYLAND  
TIN MILL CANAL MAINTENANCE

Sheet **2**

**ARM Group Inc.**  
Earth Resource Engineers and Consultants  
www.armgroup.net

No.	Revision	Date	By
2	Addressed comments from Baltimore County and MD property owner	11/29/17	ARM
1	Property owner	11/29/17	ARM

Designed	JBM	1" = 200'
Checked	TNP	Date
Drawn	JMA	11/28/2017
Project No.	170208M	

Scale: 0 200 400 600 SCALE IN FEET

This drawing, its contents, and each component of this drawing are the property of and proprietary to ARM Group Inc. and shall not be reproduced or used in any manner except for the purpose identified on the Title Block, and only by or on behalf of this client for the identified project unless otherwise authorized by the express, written consent of ARM Group Inc.



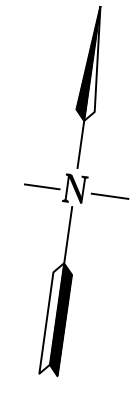

**LEGEND**

- LOD — LOD —
- LOD — LOD —
- LOD — LOD —

LIMIT OF DISTURBANCE  
HAUL ROUTE  
PCB RAIL LOADING AREA

**PROFESSIONAL CERTIFICATION**  
I hereby certify that these documents were prepared or approved by me, and that I am a duly licensed professional engineer under the laws of the State of Maryland.  
License No. 17290  
Expiration Date 03-22-2019



SEAL

This drawing, its contents, and each component of this drawing are the property of and proprietary to ARM Group Inc. and shall not be reproduced or used in any manner except for the purpose identified on the Title Block, and only by or on behalf of this client for the identified project unless otherwise authorized by the express, written consent of ARM Group Inc.

**TIN MILL CANAL WORK AREAS**

TIN MILL CANAL MAINTENANCE  
SPARROWS POINT  
BALTIMORE COUNTY, MARYLAND

Designed	JBM	1" = 500'
Checked	TNP	Date 11/28/2017
Drawn	JMA	Project No. 170208M

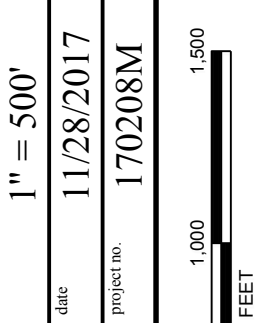

Addressed comments from Baltimore County and MDG property owner		ARM	By
2	1	11/29/17	ARM
1	1	11/29/17	ARM
Revision		Date	By





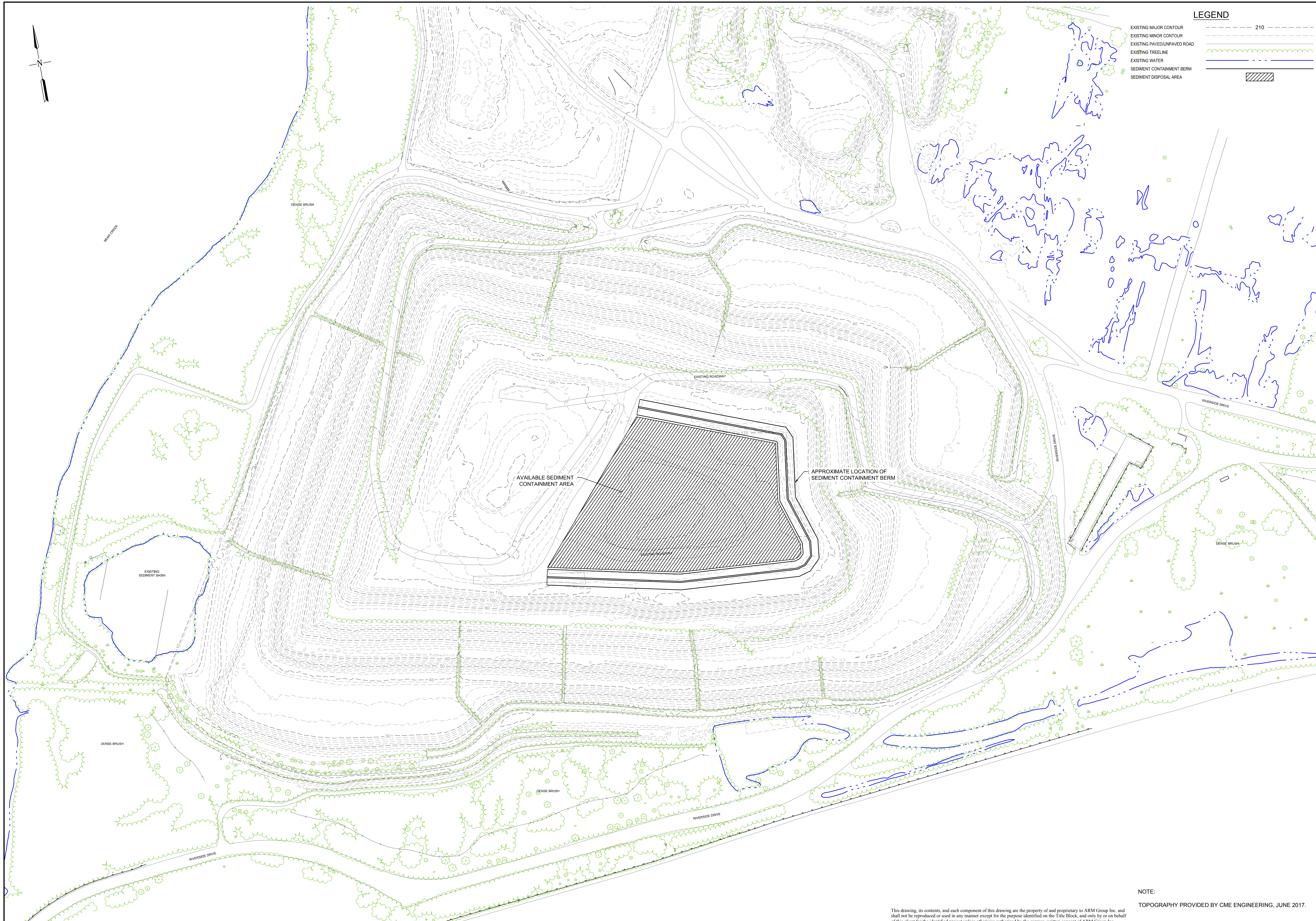

**LEGEND**

EXISTING MAJOR CONTOUR	---	210
EXISTING MINOR CONTOUR	- - - -	
EXISTING PAVED/UNPAVED ROAD	—	
EXISTING TREE LINE	~ ~ ~ ~	
EXISTING WATER	—	
SEDIMENT CONTAINMENT BERM	—	
SEDIMENT DISPOSAL AREA	▨	

**ARM Group Inc.**  
Earth Resource Engineers  
and Consultants  
www.armgroup.net

DESIGNED BY	JBM	SCALE	1" = 100'
DRAWN BY	TNP	DATE	11/28/2017
CHECKED BY	JMA	PROJECT NO.	170208M

NO.	REVISION	DATE	BY
1	Addressed comments from Baltimore County and JDE property design	11/2/17	ARM
2	Revision to incorporate adjacent property design	11/2/17	ARM

**DISPOSAL PLAN**

TIN MILL CANAL MAINTENANCE  
BALTIMORE COUNTY, MARYLAND

DESIGNED BY: JBM  
DRAWN BY: TNP  
CHECKED BY: JMA

DATE: 11/28/2017  
PROJECT NO.: 170208M

NOTE:  
TOPOGRAPHY PROVIDED BY CME ENGINEERING, JUNE 2017.

This drawing, its contents, and each component of this drawing are the property of and proprietary to ARM Group Inc. and shall not be reproduced or used in any manner except for the purpose identified on the Title Block, and only by or on behalf of this client for the identified project unless otherwise authorized by the express, written consent of ARM Group Inc.



**NOTES:**

- APPROXIMATE EXISTING BASE CHANNEL FLOW RATE = 3,000 GPM
- APPROXIMATE CHANNEL STORMWATER FLOW IS 62,800 GPM (1-YEAR STORM)
- DEWATERING DISCHARGE FROM PCB CONTAMINATED AREA SHALL BE PUMPED TO A FRAC TANK W/WEIR FOR OIL/WATER SEPARATION AND THEN THROUGH A PARTICULATE FILTER AND LIQUID GRANULAR ACTIVATED CARBON (LGAC) FILTER CONSISTING OF TWO 2,000-POUND VESSELS IN SERIES.
- ALL PUMPING SHALL BE CONDUCTED THROUGH A FILTERED INTAKE, TO MINIMIZE SEDIMENT TRANSPORT.

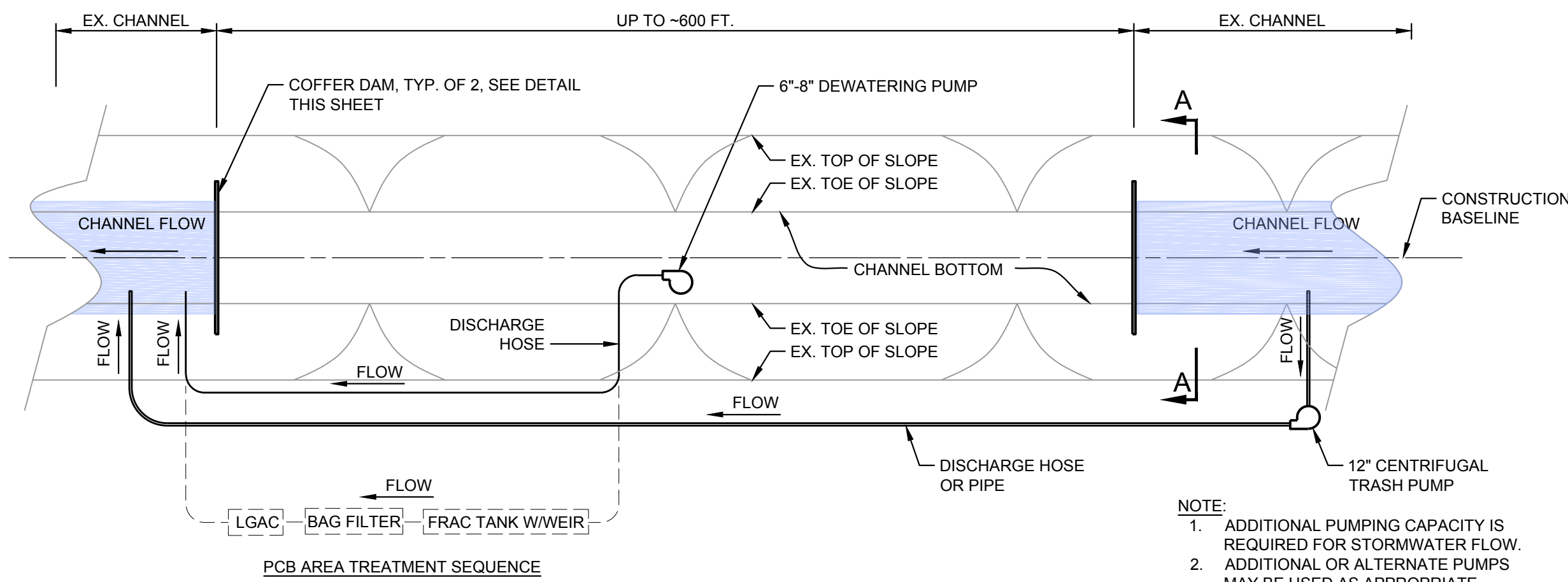

**PLAN: TYPICAL CHANNEL BYPASS PUMPING**  
SCALE: 1" = 40'

- NOTE:**
- ADDITIONAL PUMPING CAPACITY IS REQUIRED FOR STORMWATER FLOW.
  - ADDITIONAL OR ALTERNATE PUMPS MAY BE USED AS APPROPRIATE BASED ON AVAILABILITY AND FLOW.

**COFFER DAM NOTES:**

- DETAIL IS PROVIDED FOR PLANNING PURPOSES ONLY. ALL MEASUREMENTS ARE APPROXIMATE AND SHALL BE VERIFIED IN THE FIELD PRIOR TO THE EXECUTION OF WORK.
- IF THE AGGREGATE COFFER DAM DOES NOT WORK ADEQUATELY, A SANDBAG DAM, CONSTRUCTED AND MAINTAINED IN GENERAL ACCORDANCE WITH THE APPLICABLE PROVISIONS OF STANDARD DETAIL C-6 (CLEAR WATER DIVERSION PIPE) OF THE MARYLAND STANDARDS AND SPECIFICATIONS FOR SOIL EROSION AND SEDIMENT CONTROL, SHALL BE USED.

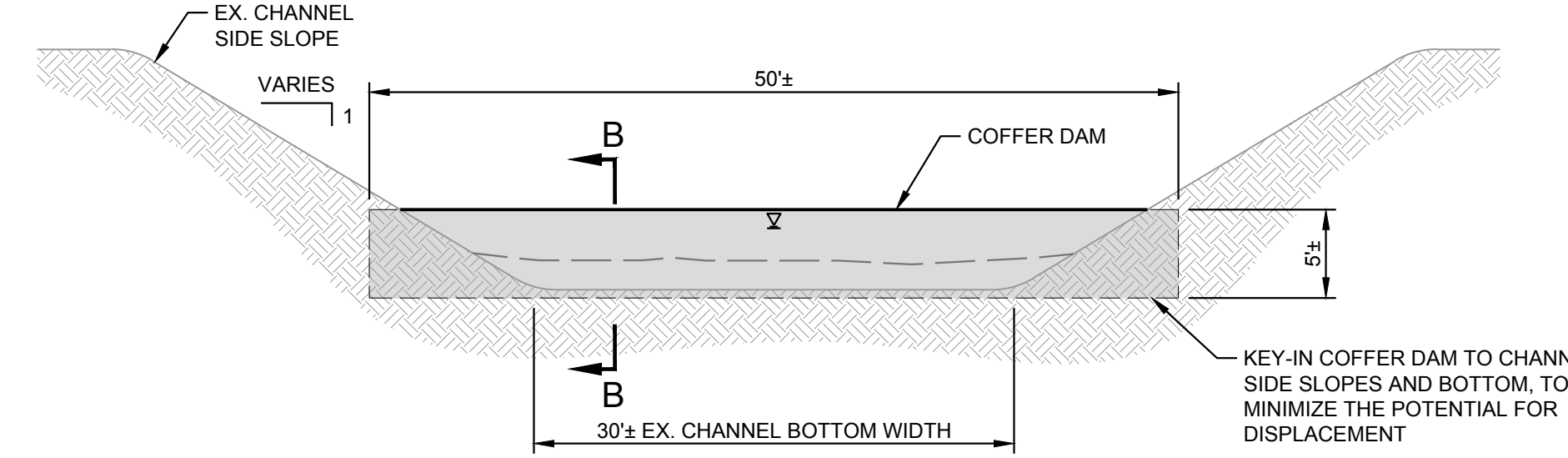

**SECTION A-A**  
SCALE: 1" = 10'

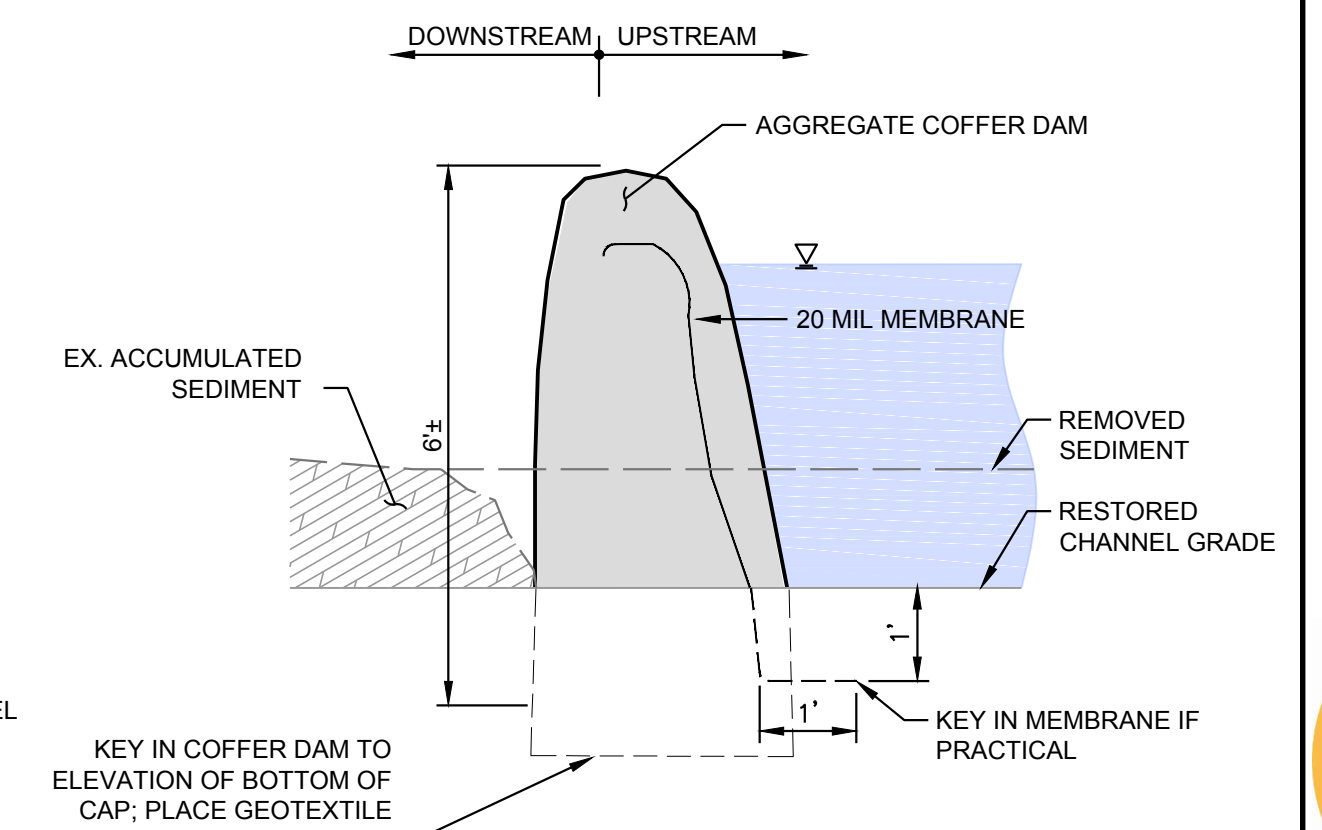

**SECTION B-B**  
SCALE: 1" = 2'

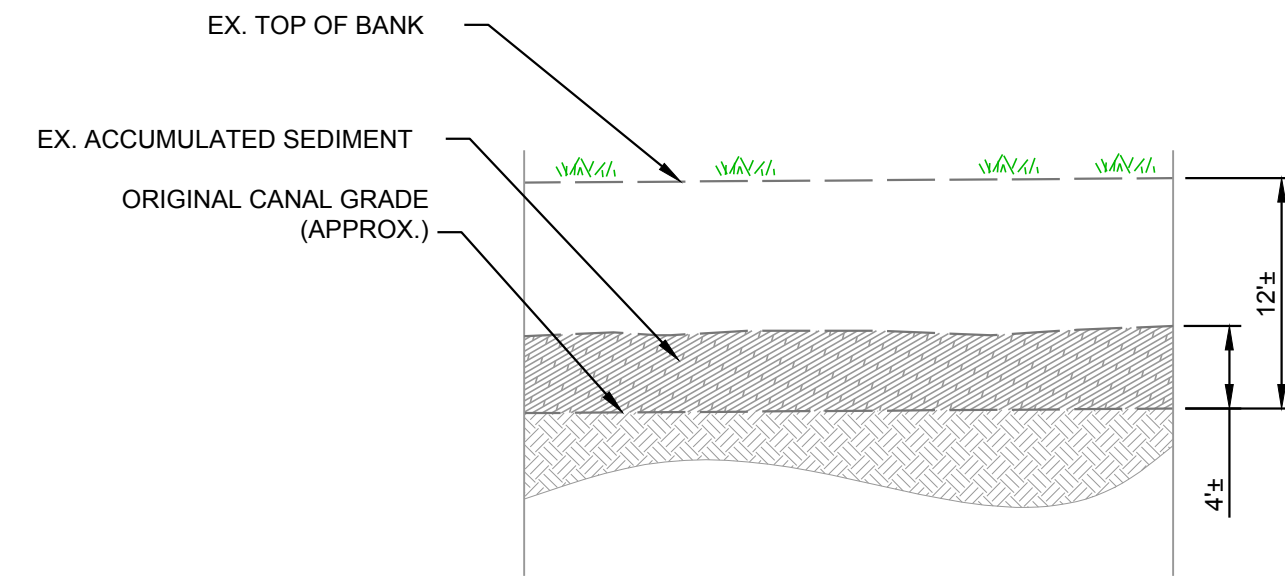

**PROFILE: TYPICAL EX. CHANNEL**  
SCALE: 1" = 10'

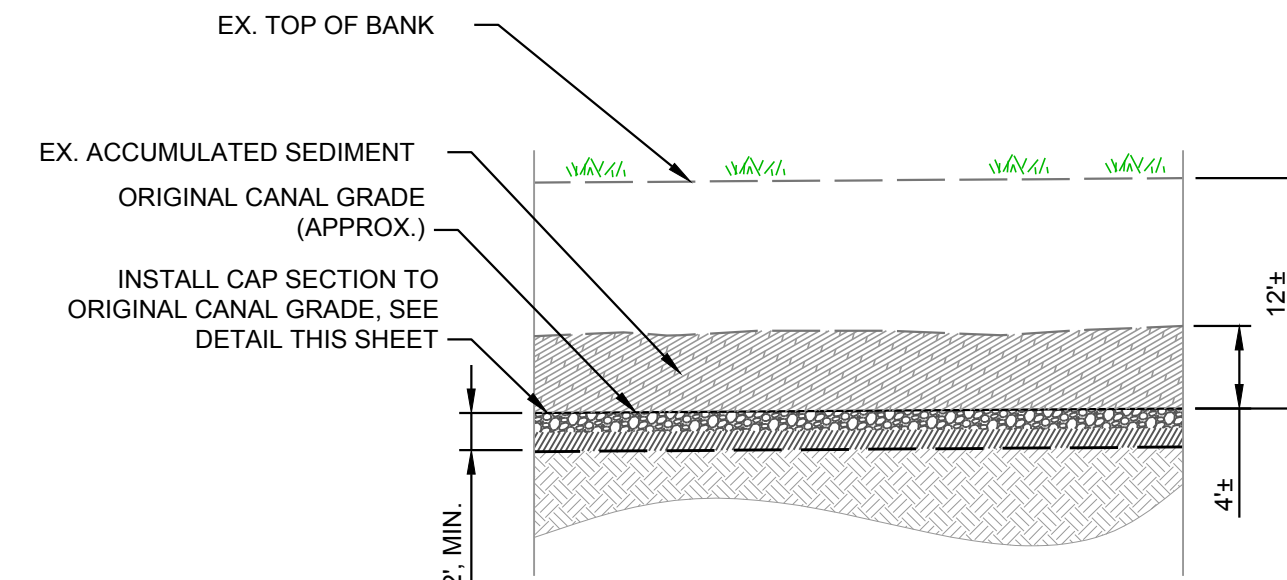

**PROFILE: TYPICAL CHANNEL CAP**  
SCALE: 1" = 10'

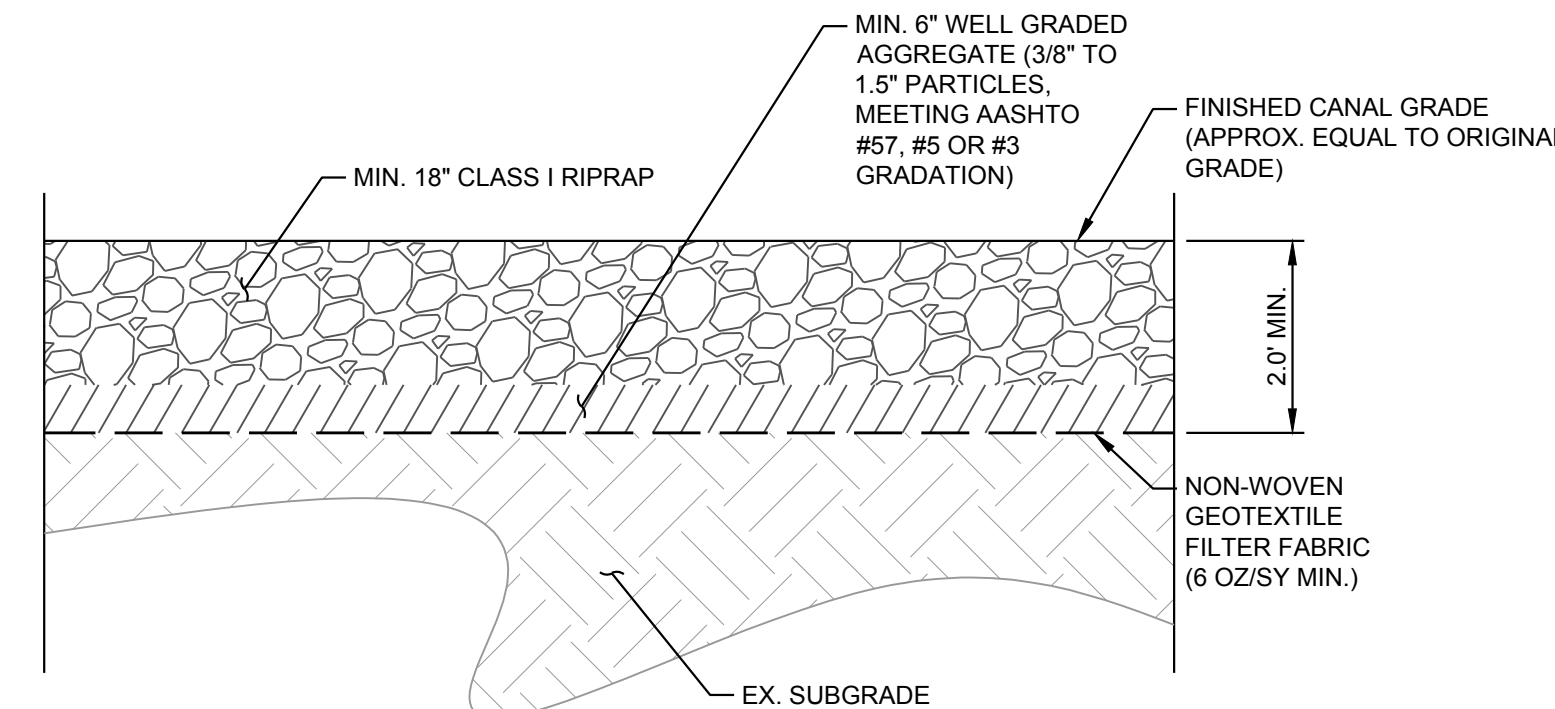

**DETAIL: TYPICAL CHANNEL CAP**  
SCALE: 1" = 2'

**GENERAL NOTES:**

- ALL DETAILS AND METHODS PRESENTED ARE SUGGESTED, AND NOTHING SHALL BE CONSTRUED AS TO RESTRICT THE CONTRACTOR'S PREFERRED MEANS AND METHODS. ALL DEVIATIONS SHALL BE PROVIDED TO THE ENGINEER FOR REVIEW AND APPROVAL.
- ALL DIMENSIONS ARE APPROXIMATE AND SHALL BE ADJUSTED BY THE CONTRACTOR TO SUIT ACTUAL CONDITIONS AND EQUIPMENT.
- FINAL CANAL GRADE WILL BE AS APPROPRIATE TO APPROXIMATELY RESTORE FLOW CAPACITY AND ALLOW FOR FREE-DRAINAGE OF OUTFALLS THAT DISCHARGE TO CANAL. ORIGINAL CANAL GRADE MAY NOT BE RESTORED AT ALL LOCATIONS.

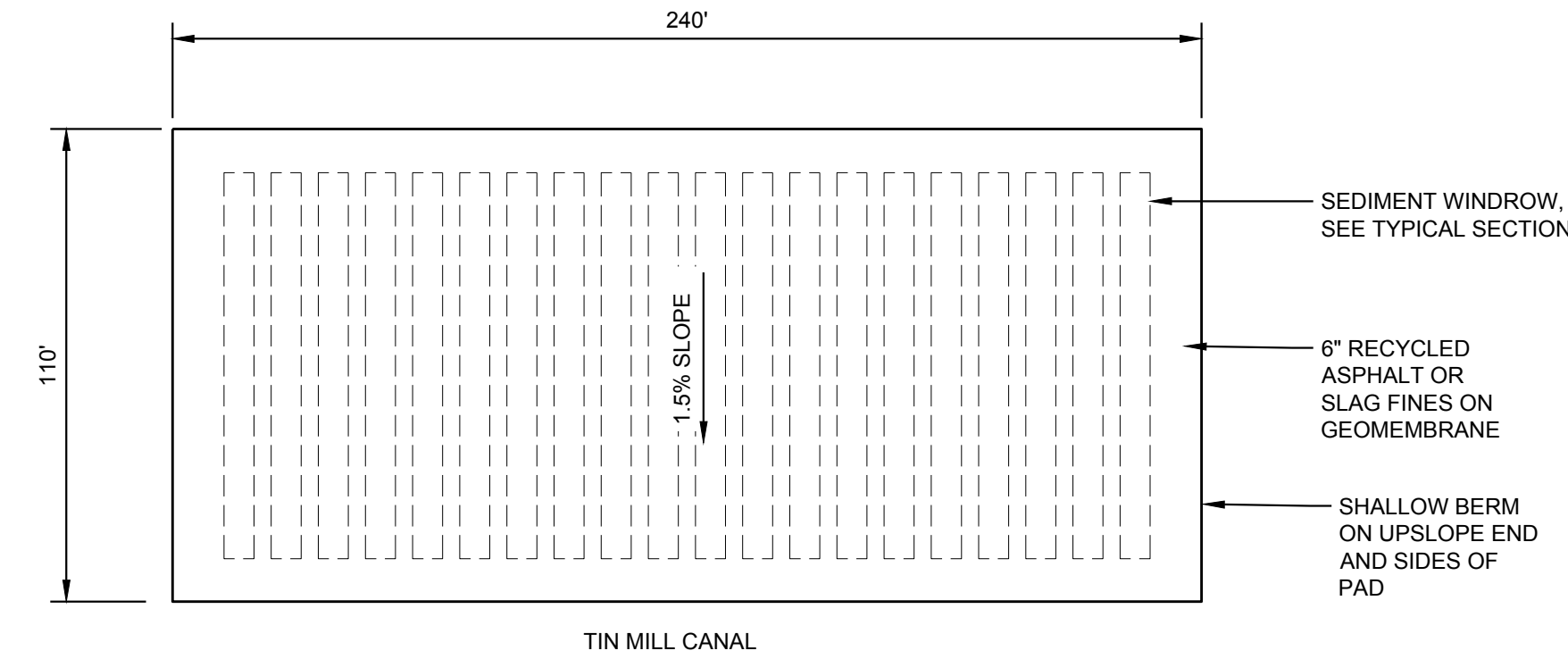

**PLAN: TYPICAL SEDIMENT DEWATERING PAD**  
SCALE: 1" = 40'

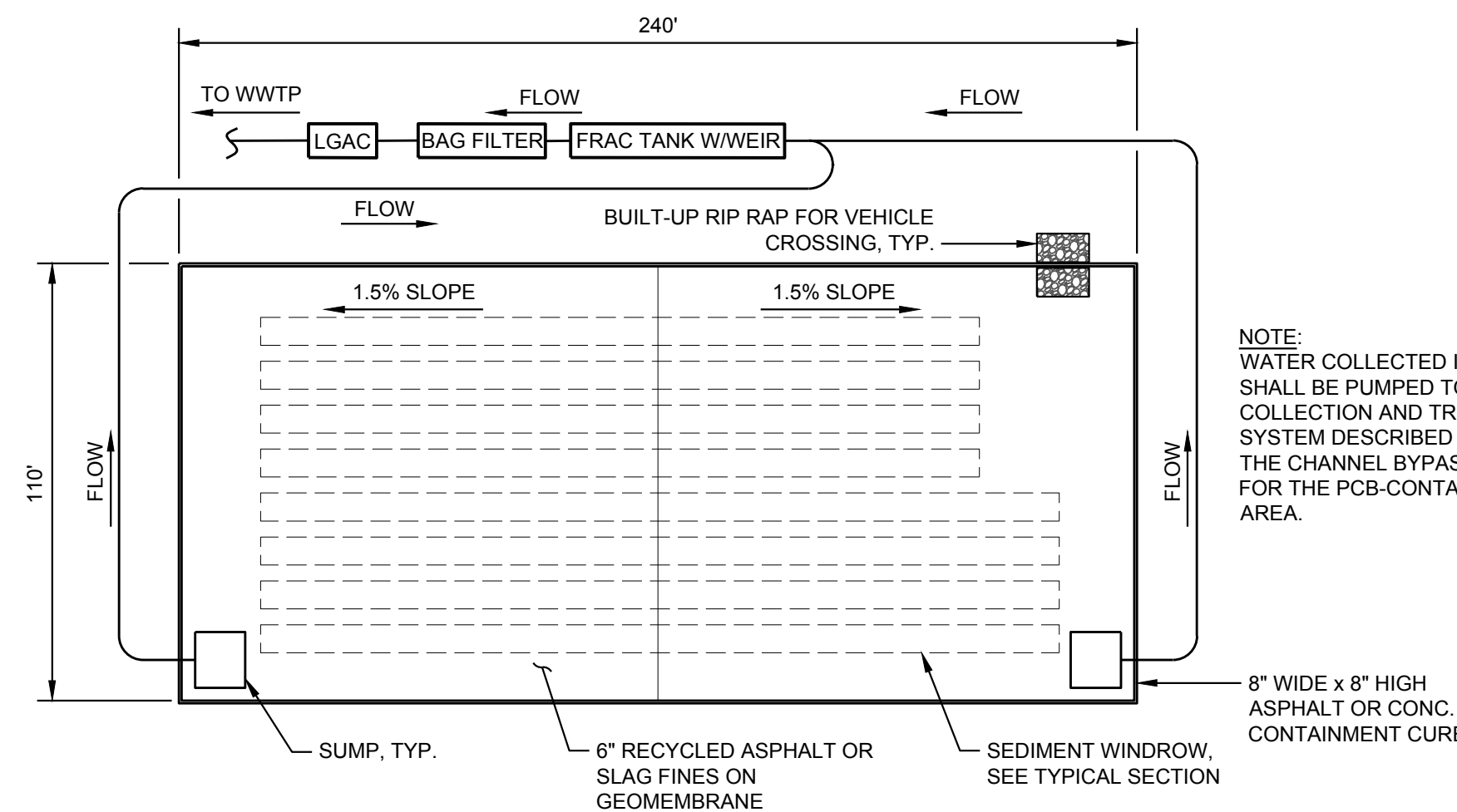

**PLAN: PCB-CONTAMINATED SEDIMENT DEWATERING PAD**  
SCALE: 1" = 40'

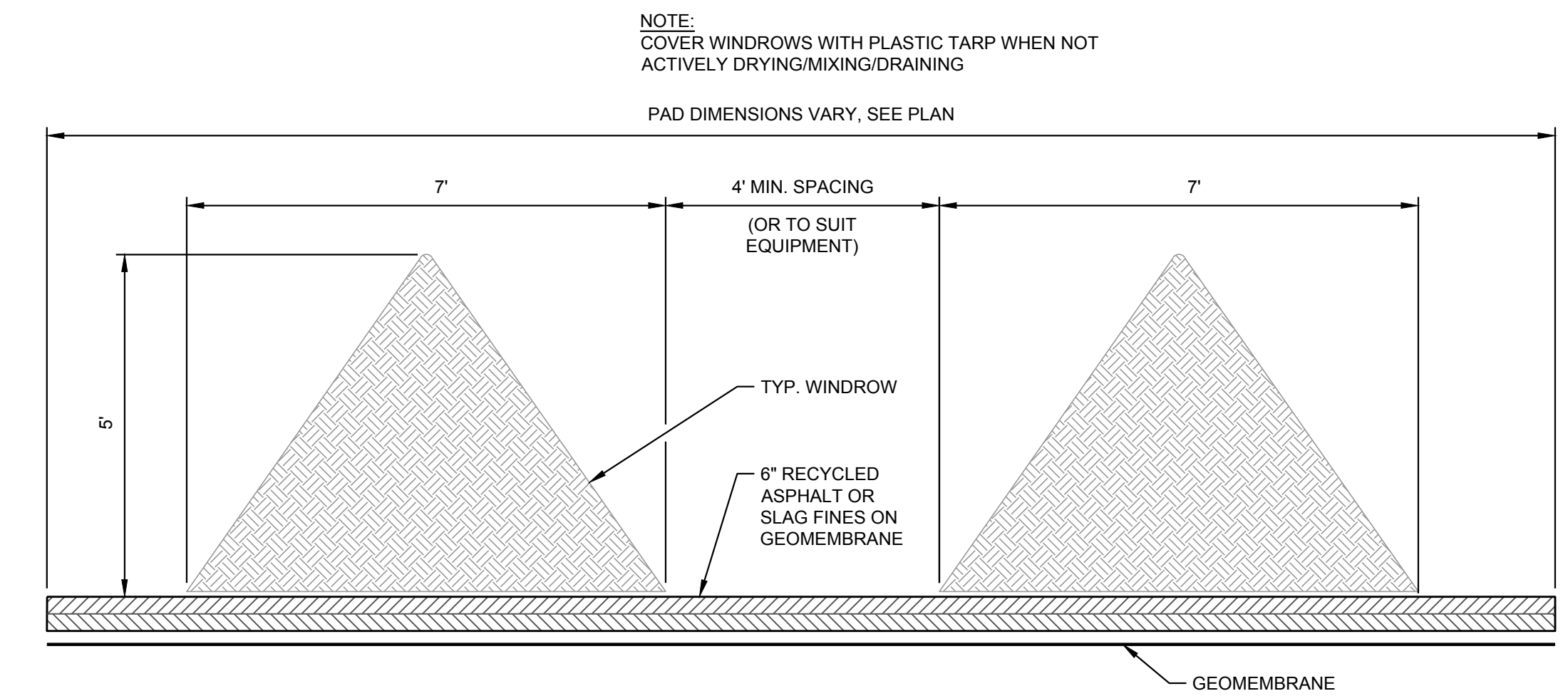

**SECTION: TYPICAL DEWATERING PAD**  
SCALE: 1" = 2'

**NOTE:**

- ALL NEW DEWATERING PADS SHALL BE REMOVED FROM SERVICE WHEN NO LONGER NEEDED. REMOVAL FROM SERVICE SHALL INCLUDE REUSING AS MUCH OF THE PAD MATERIAL AS POSSIBLE ON DOWNSLOPE PADS, WITH ANY UNSUITABLE OR UNNEEDED MATERIALS REUSED AS BACKFILL BELOW THE CANAL CAP OR TRANSPORTED TO GREYS LANDFILL FOR DISPOSAL. THE LINER AND ANY IMPACTED AGGREGATE OR OTHER MATERIALS SHALL BE PLACED INTO GREYS LANDFILL FOR DISPOSAL. SURFACE MATERIALS FROM THE DEWATERING PAD USED TO STORE PCB-IMPACTED MATERIALS SHALL BE SAMPLED FOR PCBs PRIOR TO PLACEMENT IN GREYS LANDFILL.

**PROFESSIONAL CERTIFICATION:**

I hereby certify that these documents were prepared or approved by me, and that I am a duly licensed professional engineer under the laws of the State of Maryland.

License No. 17290  
Expiration Date 03-22-2019

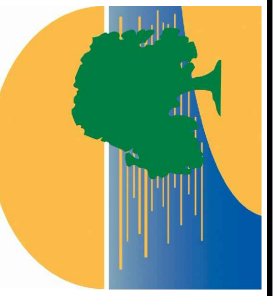
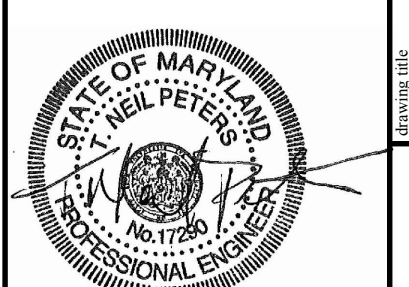

No.	Revision	Date	By
1	Addressed comments from Baltimore County and JMA property design.	11/29/17	ARM
2	Addressed comments from Baltimore County and JMA property design.	11/29/17	ARM

Design	Check	Drawn	Scale	Date
JBM	TNP	JMA	1" = 200'	11/29/2017
			170208M	





---

---

**APPENDIX A**

**Outfall Survey Summary**

---

---

**TABLE 1: FIELD OUTFALL INVESTIGATION**

Name	Type	Diameter (Nom. Inches)	Comments
Outfall A	CONCRETE	84	
Outfall B		24	buried
Outfall 34	CONCRETE	84	greater than 50 percent buried
Outfall 33a	CONCRETE	60	
Outfall 33	CONCRETE	60	
Outfall 32	CONCRETE	60	
Outfall31b	CONCRETE	84	
Outfall31c		12	outfall 31c potential location - buried
Outfall 31a	CONCRETE	48	almost completely buried
Outfall C	CONCRETE	48	partially buried
Outfall 30b	CONCRETE	60	
Outfall D	HDPE	4	
Outfall 30	CONCRETE	84	
Outfall E	pvc	8	
Outfall 45	CONCRETE	16	mostly buried
Outfall 41	STEEL	16	extend 10'
Outfall 42	CONCRETE	60	partially buried
Outfall F	fiberglass	60	
Outfall G	pvc	4	
Outfall H	pvc	4	
Outfall I	pvc	8	
Outfall J	CONCRETE	72	partially buried
	STEEL	16	partially buried
Outfall K	STEEL	16	
Outfall L	STEEL	18	
Outfall M	STEEL	1	
Outfall N	pvc	4	
Outfall O	STEEL	6	extend 10'
Outfall P	STEEL	18	rusted out - no longer in use
Outfall Q	pvc	4	
Outfall R	STEEL	18	extend out 15'
Outfall S	HDPE	4	adjacent to railroad bridge
Outfall T	HDPE	4	adjacent to railroad bridge
Outfall U	CONCRETE	60	
Outfall V	HDPE	8	
Outfall W	STEEL	18	
Outfall X	STEEL	18	
Outfall Y	pvc	6	
Outfall Z	CONCRETE	48	
Unnamed	Unknown	30" and 4"	just east and west of vehicle bridge



**PHOTOGRAPHIC LOG**



Outfall A: 3/29/2017



Outfall B: 3/29/17



Outfall 34: 3/29/17



Outfall 33a: 3/29/17



Outfall 33: 3/29/17



Outfall 32: 3/29/2017



**PHOTOGRAPHIC LOG**



Outfall 31b: 3/29/17



Outfall 31c: 3/29/2017



Outfall 31a: 3/29/17



Outfall C: 3/29/17



Outfall 30b: 3/29/2017



Outfall D: 3/29/17



**PHOTOGRAPHIC LOG**



Outfall 30: 3/29/17



Outfall E: 3/29/2017



Outfall 45: 3/29/17



Outfall 41: 3/29/17



Outfall 42: 3/29/2017



Outfall F: 3/29/17



**PHOTOGRAPHIC LOG**



Outfall G: 3/29/17



Outfall H: 3/29/2017



Outfall I: 3/29/17



Outfall J: 3/29/17



Outfall K: 3/29/2017



Outfall L: 3/29/17



**PHOTOGRAPHIC LOG**



Outfall M: 3/29/17



Outfall N: 3/29/2017



Outfall O: 3/29/17

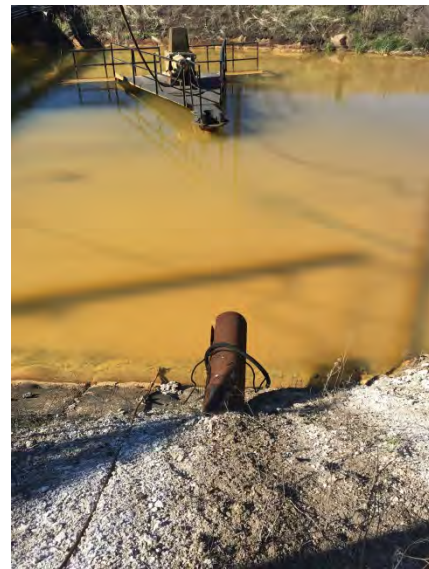

Outfall P: 3/29/17



Outfall Q: 3/29/2017



Outfall R: 3/29/17



**PHOTOGRAPHIC LOG**



Outfall S: 3/30/17



Outfall T: 3/30/2017



Outfall U: 3/30/17



Outfall V: 3/30/17



Outfall W: 3/30/2017



Outfall X: 3/30/17



**PHOTOGRAPHIC LOG**



Outfall Y: 3/30/17



Outfall Z: 3/30/2017

TIM MILL CANAL OUTFALL FIELD SHOT LOCATIONS

OUTFALL NAME	POINT NUMBER	NORTHING	EASTING	ELEVATION	MATERIAL	SIZE	LOCATION OF SHOT
OUTFALL 41	2476	569000.41	1457713.16	0.6	STEEL	16"	TOP OF PIPE
OUTFALL 42	2432	568993.00	1457753.22	1.8	REINFORCED CONCRETE	60"	TOP OF PIPE
OUTFALL 42	2433	568993.33	1457753.21	1.4	REINFORCED CONCRETE	60"	TOP OF COLLAR
OUTFALL J	2434	569037.84	1458002.57	3.4	REINFORCED CONCRETE	72"	TOP OF PIPE
OUTFALL K	2435	569181.51	1458292.77	1.6	STEEL	12"	TOP OF PIPE
OUTFALL L	2436	569315.80	1458571.78	3.0	STEEL	16"	TOP OF PIPE
OUTFALL I	2437	569416.04	1459282.14	8.6	PVC	8"	TOP OF PIPE
OUTFALL E	2438	569436.14	1459515.28	8.9	PVC	8"	TOP OF PIPE
OUTFALL 30	2439	569452.55	1459541.17	5.6	REINFORCED CONCRETE	84"	TOP OF PIPE
OUTFALL 30	2440	569452.64	1459540.60	5.2	REINFORCED CONCRETE	84"	TOP OF COLLAR
OUTFALL D	2441	569587.31	1459816.10	5.3	PVC	4"	TOP OF PIPE
OUTFALL 30D	2442	569793.57	1459897.10	4.8	REINFORCED CONCRETE	60"	TOP OF PIPE
OUTFALL 30D	2443	569793.52	1459896.78	4.6	REINFORCED CONCRETE	60"	TOP OF COLLAR
OUTFALL 30D	2444	569793.42	1459896.64	1.5	REINFORCED CONCRETE	60"	INVERT OF PIPE
OUTFALL C	2445	570137.26	1459868.25	1.1	TERRA COTTA	30"	TOP OF PIPE
OUTFALL 31A	2446	570407.86	1459842.77	0.9	REINFORCED CONCRETE	48"	TOP OF PIPE
OUTFALL 31A	2447	570407.84	1459842.17	-1.3	REINFORCED CONCRETE	48"	INVERT OF PIPE±
OUTFALL G	2448	570730.62	1459845.98	4.7	PVC PERFORATED	4"	TOP OF PIPE
OUTFALL H	2449	570766.68	1459847.64	4.7	PVC	4"	TOP OF PIPE
OUTFALL 31C	2450	571280.63	1460037.68	1.9	REINFORCED CONCRETE	12"	TOP OF PIPE
OUTFALL 31B	2451	571484.63	1460360.38	5.3	REINFORCED CONCRETE	72"	TOP OF PIPE
OUTFALL 31B	2452	571485.11	1460360.28	4.9	REINFORCED CONCRETE	72"	TOP OF PIPE
OUTFALL 32	2453	571532.74	1460690.34	2.8	REINFORCED CONCRETE	42"	TOP OF PIPE
OUTFALL 32	2454	571533.12	1460690.36	2.6	REINFORCED CONCRETE	42"	TOP OF PIPE
OUTFALL 33	2455	571566.25	1460997.25	3.7	REINFORCED CONCRETE	54"	TOP OF PIPE
OUTFALL 33	2456	571566.47	1460997.19	3.3	REINFORCED CONCRETE	54"	TOP OF PIPE
OUTFALL 33A	2457	571599.80	1461275.29	3.2	REINFORCED CONCRETE	54"	TOP OF PIPE
OUTFALL 33A	2458	571600.24	1461275.27	2.9	REINFORCED CONCRETE	54"	TOP OF COLLAR
OUTFALL 34	2459	571653.02	1461849.52	4.2	REINFORCED CONCRETE	84"	TOP OF PIPE
OUTFALL B	2460	571699.67	1462293.29	5.9	CONCRETE HEADWALL	24"	TOP OF CONCRETE HEADWALL
OUTFALL B	2461	571699.17	1462296.95	5.7	CONCRETE HEADWALL	24"	XXXX
OUTFALL B	2462	571699.34	1462290.13	5.7	CONCRETE HEADWALL	24"	XXXX
OUTFALL B	2463	571698.56	1462290.20	5.7	CONCRETE HEADWALL	24"	XXXX
OUTFALL A	2464	571942.69	1463365.56	4.9	REINFORCED CONCRETE	84"	TOP OF PIPE
OUTFALL Z	2465	571894.44	1462998.80	2.9	REINFORCED CONCRETE	36"	INVERT OF PIPE
OUTFALL Z	2466	571894.93	1462999.19	6.3	CONCRETE HEADWALL	36"	TOP OF CONCRETE HEADWALL
OUTFALL W	2467	571560.19	1460416.34	5.7	STEEL	12"	TOP OF PIPE
OUTFALL X	2468	571411.14	1460084.58	3.4	STEEL	12"	INVERT OF PIPE
OUTFALL Y	2469	571360.97	1460019.80	8.1	METAL	6"	INVERT OF PIPE
OUTFALL V	2470	571126.18	1459848.07	5.2	PVC	6"	TOP OF PIPE
OUTFALL U	2471	570917.01	1459758.08	6.4	REINFORCED CONCRETE	48"	TOP OF PIPE
OUTFALL U	2472	570917.08	1459758.06	1.9	REINFORCED CONCRETE	48"	INVERT OF PIPE
OUTFALL T	2473	570826.73	1459776.57	5.0	PVC PERFORATED	4"	INVERT OF PIPE
OUTFALL T	2474	570791.03	1459771.91	5.2	PVC	4"	INVERT OF PIPE
OUTFALL F	2475	569071.54	1457914.46	-3.9	FIBERGLASS	60"	INVERT OF PIPE



---

---

## **APPENDIX B**

### **Supporting Calculations**

---

---



## DESCRIPTION

Estimate the total amount of:

- wet excavated sediment;
- dried volume of sediment for on-site disposal;
- dried volume of PCB-contaminated sediment for off-site disposal;
- volume of ordinary (non-PCB-impacted) water potentially requiring treatment;
- volume of PCB-impacted water potentially requiring treatment; and
- estimated rate of flow for dewatering pumping.

## SUMMARY

The total volume of excavated sediments that are not contaminated with PCBs is estimated as 62,222 yd<sup>3</sup>; after drying and potential reagent addition, the estimated volume to be disposed of in the on-site industrial waste landfill (Greys landfill) is approximately 70,000 yd<sup>3</sup>. The total volume of excavated PCB-contaminated sediments is estimated as 8,889 yd<sup>3</sup>; after drying and potential reagent addition, the estimated volume to be disposed of in an off-site TSCA-permitted landfill is approximately 10,000 yd<sup>3</sup>. The volume of PCB contact water is estimated as 500,000 gallons (0.5 MG); the contact water will be passed through an oil-water separator and granular activated-carbon filter (GAC) before discharge to the on-site wastewater treatment plant influent. The volume of ordinary (non-PCB contact) water expected to drain from the excavated sediments is estimated as 3 million gallons (3.0 MG); this water will be discharged to the wastewater treatment plant influent.

## CALCULATIONS

### I. Calculate Volume of Sediment

#### A. Assumptions

- Assume existing sediments are, on average, 2.0 ft above the original grade;
- Assume the excavation depth for the PCB contaminated area is 8 ft, on average;
- Assume the initial moisture content,  $w$ , of excavated sediments is 40% by weight based on the geotechnical investigation;
- Assume the initial saturation of excavated sediments is 100%;



- Assume the dry unit weight,  $\gamma_d$ , of excavated sediments is 78 lb/ft<sup>3</sup> based on the geotechnical investigation;
- Assume the boundary (containment) layer thickness is 2.0 ft, and is installed with the top elevation at the original canal grade;
- Assume the soils below the original canal grade have the same moisture content and density as the excavated sediments;
- Assume final moisture content of sediments after drying is 20%; and
- Assume the volume and weight of solids is constant before and after drying.

B. Calculate Quantity of Wet Material

For:

$L = 7000$  feet (non-PCB sediments)

$L_{PCB} = 500$  feet (PCB sediments)

$W = 60$  feet

$D = 4$  feet (2 feet non-PCB sediments + 2 feet below original canal grade)

$D_{PCB} = 8$  feet

And,

$$V = L \times W \times D = 7000 \text{ ft} \times 60 \text{ ft} \times 4 \text{ ft} = 1,680,000 \text{ ft}^3 = 62,222 \text{ yd}^3$$

$$V = L_{PCB} \times W \times D_{PCB} = 500 \text{ ft} \times 60 \text{ ft} \times 8 \text{ ft} = 240,000 \text{ ft}^3 = 8,889 \text{ yd}^3$$

$$V_{\text{total}} = 62,222 \text{ yd}^3 + 8,889 \text{ yd}^3 = 71,111 \text{ yd}^3 \quad \text{Say, } \mathbf{72,000 \text{ yd}^3}$$

C. Estimate Material Quantities for Disposal:

To be conservative, assume that the loss of free-draining fluids doesn't change the dry density or volume of the excavated sediments.

Based on the initial treatability results, assume that 10% reagent by volume is added to the excavated sediments, and that the dry density of the resulting mixture does not increase.

The resulting volumes of material to be disposed of are estimated as follows:



- Disposal of non-PCB sediments at on-site Landfill (Greys):

$$\text{Volume} = 62,222 \text{ yd}^3 \times 1.1 = 68,444 \text{ yd}^3 \quad \text{Say, } \mathbf{70,000 \text{ yd}^3}$$

- Disposal of PCB sediments at TSCA Landfill:

$$\text{Volume} = 8,889 \text{ yd}^3 \times 1.1 = 9,778 \text{ yd}^3 \quad \text{Say, } \mathbf{10,000 \text{ yd}^3}$$

D. Estimate Volume of Water Released from Sediments:

Assume that the dry density of the material doesn't change during draining, and that the moisture content drops by approximately 20% (e.g., from 40% to 20%).

- Water loss weight per cubic foot = 78 lbs (0.4-0.2) = 15.6 lbs
- Water loss volume per cubic foot = 15.6 lbs (7.48 gal/62.4 lbs) = 1.87 gallons
- Water loss for non-PCB sediments:

$$1,680,000 \text{ ft}^3 \times 1.87 \text{ gallons/ft}^3 = 3,141,600 \text{ gallons} \quad \text{Say, } \mathbf{3 \text{ MG}}$$

- Water loss for PCB-impacted sediments:

$$240,000 \text{ ft}^3 \times 1.87 \text{ gallons/ft}^3 = 448,800 \quad \text{Say, } \mathbf{0.5 \text{ MG}}$$

E. Estimate Base Flow of Groundwater for Pumping:

Total base flow along canal was previously estimated as 3,000 gallons per minute (gpm), along the 7,500 foot long canal.

For each ~600 foot working section, the base flow would be:

$$3,000 \text{ gpm} (600 \text{ ft}/7,500 \text{ ft}) = 240 \text{ gpm}$$

Pumping requirements would be required to handle base flow plus leakage through coffer dams.

### Tin Mill Canal Velocity and Riprap Calculations

Outfall	Type	Diameter in	Mannings N	S ft/ft	A sq ft	R ft	Mannings Q cfs	TR-55 Q cfs	V fps	Required Riprap Size
M	STEEL	1	0.012	0.005	0.01	0.02	0.00		0.66	Class 0
D	HDPE	4	0.01	0.005	0.09	0.08	0.18		2.01	Class 0
G	PVC	4	0.01	0.005	0.09	0.08	0.18		2.01	Class 0
H	PVC	4	0.01	0.005	0.09	0.08	0.18		2.01	Class 0
N	PVC	4	0.01	0.005	0.09	0.08	0.18		2.01	Class 0
Q	PVC	4	0.01	0.005	0.09	0.08	0.18		2.01	Class 0
S	HDPE	4	0.01	0.005	0.09	0.08	0.18		2.01	Class 0
T	HDPE	4	0.01	0.005	0.09	0.08	0.18		2.01	Class 0
O	STEEL	6	0.012	0.005	0.20	0.13	0.43		2.19	Class 0
Y	PVC	6	0.01	0.005	0.20	0.13	0.52		2.63	Class 0
E	PVC	8	0.01	0.005	0.35	0.17	1.11		3.19	Class 0
I	PVC	8	0.01	0.005	0.35	0.17	1.11		3.19	Class 0
V	HDPE	8	0.01	0.005	0.35	0.17	1.11		3.19	Class 0
41	STEEL	16	0.012	0.005	1.40	0.33	5.89		4.22	Class 0
K	STEEL	16	0.012	0.005	1.40	0.33	5.89		4.22	Class 0
L	STEEL	18	0.012	0.005	1.77	0.38	8.07		4.57	Class 0
P	STEEL	18	0.012	0.005	1.77	0.38	8.07		4.57	Class 0
R	STEEL	18	0.012	0.005	1.77	0.38	8.07		4.57	Class 0
W	STEEL	18	0.012	0.005	1.77	0.38	8.07		4.57	Class 0
X	STEEL	18	0.012	0.005	1.77	0.38	8.07		4.57	Class 0
C	CONCRETE	48	0.011	0.005	12.57	1.00	120.36	36.48	8.38	Class I
Z	CONCRETE	48	0.011	0.005	12.57	1.00	120.36	583.48	9.58	Class I
32	CONCRETE	60	0.011	0.005	19.63	1.25	218.23	98.52	10.81	Class I
33	CONCRETE	60	0.011	0.005	19.63	1.25	218.23	35.83	8.20	Class I
42	CONCRETE	60	0.011	0.005	19.63	1.25	218.23	266.81	11.11	Class I
30B	CONCRETE	60	0.011	0.005	19.63	1.25	218.23	41.60	8.56	Class I
33A	CONCRETE	60	0.011	0.005	19.63	1.25	218.23	156.74	12.07	Class I
F	FIBERGLASS	60	0.009	0.005	19.63	1.25	266.73	301.98	13.58	Class I
U	CONCRETE	60	0.011	0.005	19.63	1.25	218.23	44.80	8.74	Class I
J	CONCRETE	72	0.011	0.005	28.27	1.50	354.87	444.64	12.55	Class I
30	CONCRETE	84	0.011	0.005	38.48	1.75	535.29	105.56	10.80	Class I
34	CONCRETE	84	0.011	0.005	38.48	1.75	535.29	589.26	13.91	Class I
31B	CONCRETE	84	0.011	0.005	38.48	1.75	535.29	51.84	8.80	Class I
A	CONCRETE	84	0.011	0.005	38.48	1.75	535.29	390.26	15.15	Class I
45	CONCRETE									
31A	CONCRETE									
31C										
B										

Notes: Where Manning's Q and TR-55 Q are shown, the smaller of the two was used for culvert outfall protection calculations.  
Minimum riprap sizing was established based on Maryland guidance for the design of outlet protection.

Channel	Side Slope	Depth ft	Mannings N	S ft/ft	A sq ft	R ft	Mannings Q cfs	TR-55 Q cfs	Mannings V fps	TR-55 V fps	Required Riprap Size
33 FT BOTTOM	2:1	8	0.03	5E-04	392	5.7	512.27	1236.8	1.31	3.16	Class 0
50 FT BOTTOM	2:1	8	0.03	5E-04	528	6.16	736.32	1236.8	1.39	2.34	Class 0

Note: Class 0 riprap is generally acceptable for velocities of up to 4 fps; Class I riprap is generally acceptable for velocities up to 7 fps.

DESIGN OF OUTLET PROTECTION  
MAXIMUM TAILWATER CONDITION ( $T_w \geq 0.5 \text{ diam.}$ )

For full flow, use  $d$ =pipe diameter and discharge ( $Q$ ) to determine riprap size and apron length.

For partial flow or open channels, use  $d$ =flow depth and velocity ( $V$ ) to determine riprap size and apron length.

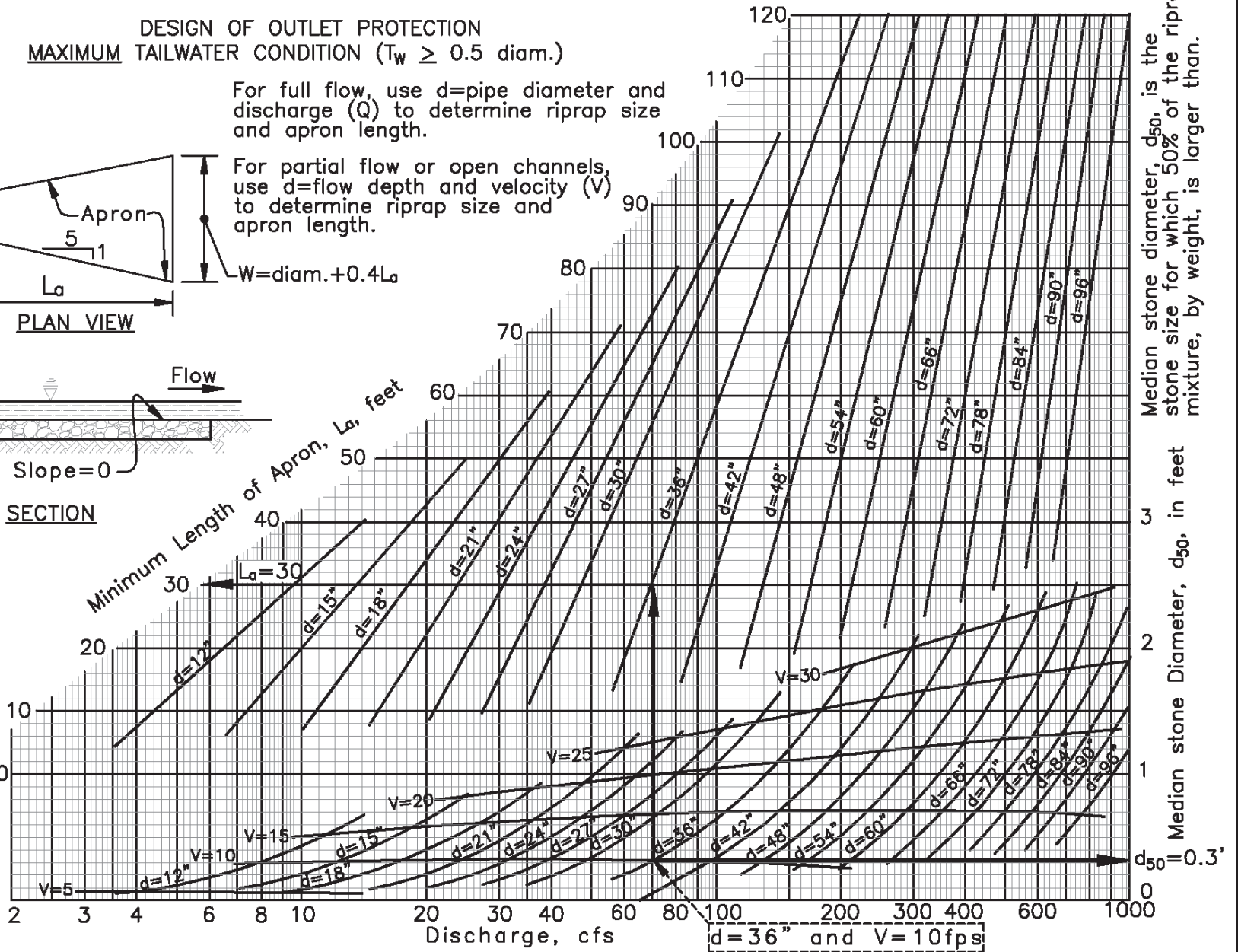
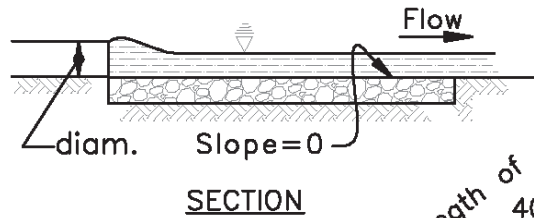
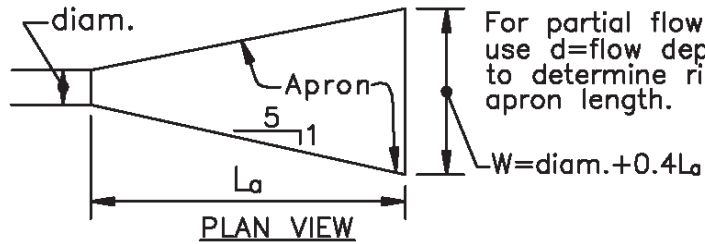

Figure D.3: Design of Outlet Protection – Maximum Tailwater Condition



## **DESCRIPTION**

Evaluate Greys Landfill slope stability following proposed placement of Tin Mill Canal (TMC) sediments. This analysis supplements the analyses presented in the June 2015 report entitled “Greys Landfill Slope Stability Analysis, Sparrow’s Point, MD”, prepared by ARM Group Inc. (ARM) for EnviroAnalytics Group.

## **SUMMARY**

Based on a detailed slope stability analysis, the proposed placement of TMC sediments into the on-site Greys Landfill will not result in unacceptable factors of safety against failure. In particular, the factors of safety determined for the most critical circular and translational failure surfaces are 1.7 and 2.2, respectively, for static conditions, and 1.3 and 1.5, respectively, for seismic loading conditions. These values are essentially the same as the values previously calculated for the planned landfilling activities (as presented in the above-referenced June 2015 report), and are higher than the minimum required values of 1.5 and 1.0 for static and seismic loading conditions, respectively.

## **CALCULATIONS**

### **I. Compacted TMC Sediments**

The characteristics of the TMC sediment layer were generally estimated as follows:

- Based on the sediment characterization and treatability testing, the total unit weight of the TMC sediments, following drying and possible reagent addition to eliminate free liquids, and placement and compaction into the landfill in approximately 1 foot lifts, was estimated as approximately 110 pounds per cubic foot (pcf). To be conservative, a value of 125 pcf was used for the analysis.
- The strength parameters of the compacted sediments (largely low-plasticity silts) were estimated from published documents and professional experience as follows: internal angle of friction = 26 degrees and cohesion = 0. To be conservative, an internal friction angle value of 10 degrees with used for the analysis.
- It was assumed that the sediments will be placed and compacted on a relatively flat area at the top of the landfill as generally shown on Sheet 4 of the project drawings. Based on the approximate sediment disposal area of 160,000 square feet (sf), and the estimated sediment volume of 70,000 cubic yards (cy) as presented in the TMC maintenance work





plan, the thickness of the sediment layer was calculated as approximately 12 feet (i.e., [70,000 cy x 27 cubic feet per cy]/160,000 sf = 11.8 feet)

## II. Slope Stability Analysis

A commercially available slope stability program (SLIDE) was used to support the slope stability analysis. Except for the addition of a 12-foot-thick compacted sediment layer as discussed above, the modeling approach and parameters, including landfill slope geometry, thickness and properties of the other soil and waste layers, and worst-case slope section for the eastern half of the landfill (i.e., Section 4, as shown on the attached figure entitled “Preliminary Slope Stability Analysis”), were consistent with those used for the previous slope stability analyses as presented in the June 2015 slope stability report for Greys Landfill.

The critical failure surfaces identified from the slope stability analysis are shown on the attached figures and are summarized in the table below:

Failure Type - Loading	FACTORS OF SAFETY FOR SECTION 4	
	From June 2015 Report	With TMC Sediments
Circular - Static	1.7	1.7
Circular - Seismic	1.3	1.3
Translational - Static	2.3	2.2
Translational - Seismic	1.7	1.5

## CONCLUSIONS

Based on the slope stability analysis, the proposed placement of TMC sediments into the on-site Greys Landfill will not result in unacceptable factors of safety against failure. The calculated factors of safety against failure are essentially the same as the values previously calculated for the planned landfilling activities, and are higher than the minimum required values of 1.5 and 1.0 for static and seismic loading conditions, respectively.



**LEGEND**

B-1  BORING LOCATION

NOTE:  
 BASE PLAN PROVIDED BY HARFORD AERIAL SURVEYS, INC.  
 DATE OF PHOTOGRAPHY: MARCH 12, 2015.



designed	BSA	scale	1" = 200'
checked	WST	date	06/30/2015
drawn	SEH	project no.	150172
		0	200
			400
			SCALE IN FEET

**PRELIMINARY SLOPE STABILITY ANALYSIS**  
 SPARROW'S POINT  
 BALTIMORE COUNTY, MD

GREY'S LANDFILL  
 ENVIROANALYTICS GROUP

Figure **1**

\\armcentral\Projects\Enviro-Analytics\Group\150172M EAG Greys Landfill Stability\Draw\Production\Figures\150172-FLC-101\Slide(063015).dwg Plotted: June 30, 2015

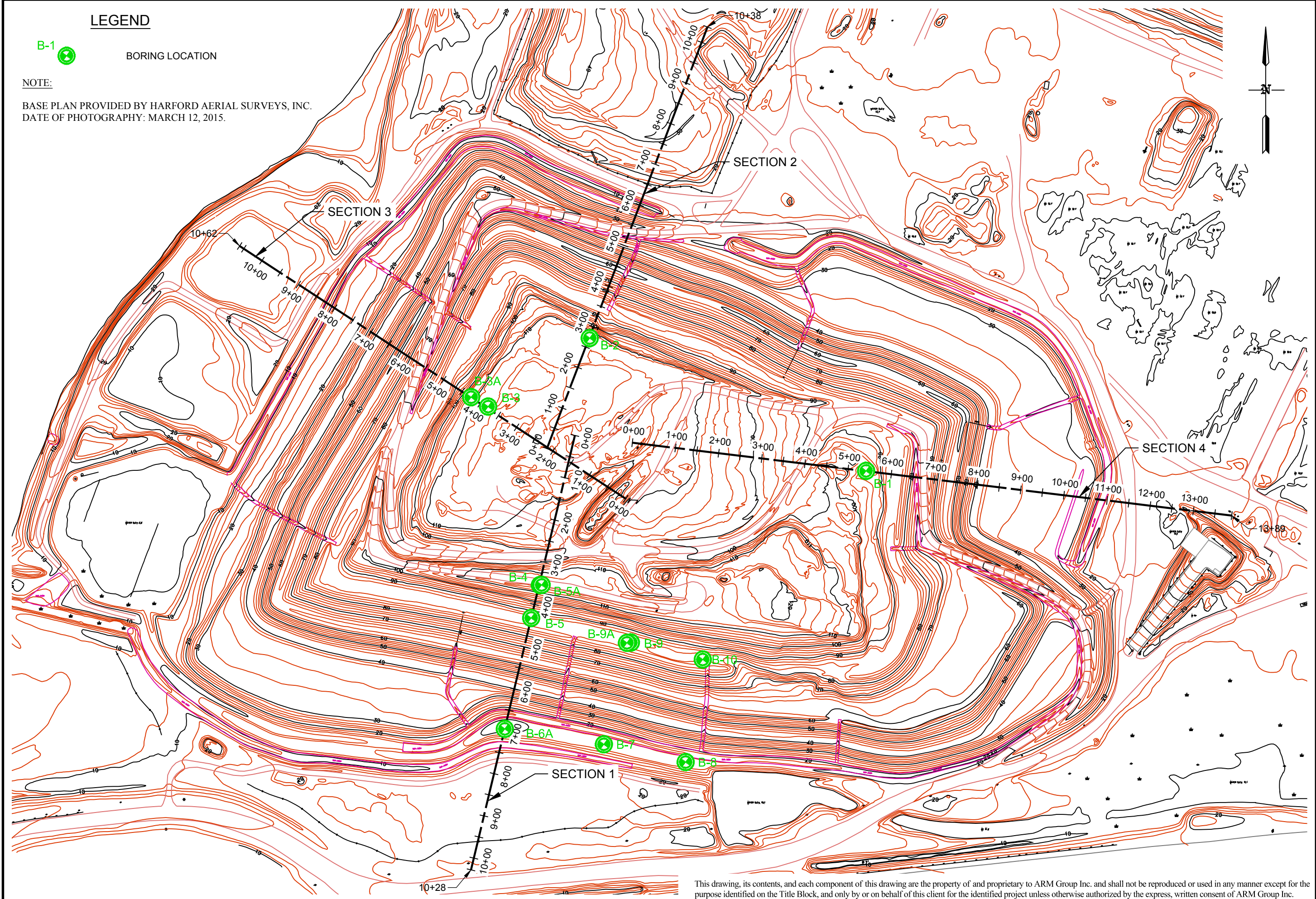

This drawing, its contents, and each component of this drawing are the property of and proprietary to ARM Group Inc. and shall not be reproduced or used in any manner except for the purpose identified on the Title Block, and only by or on behalf of this client for the identified project unless otherwise authorized by the express, written consent of ARM Group Inc.



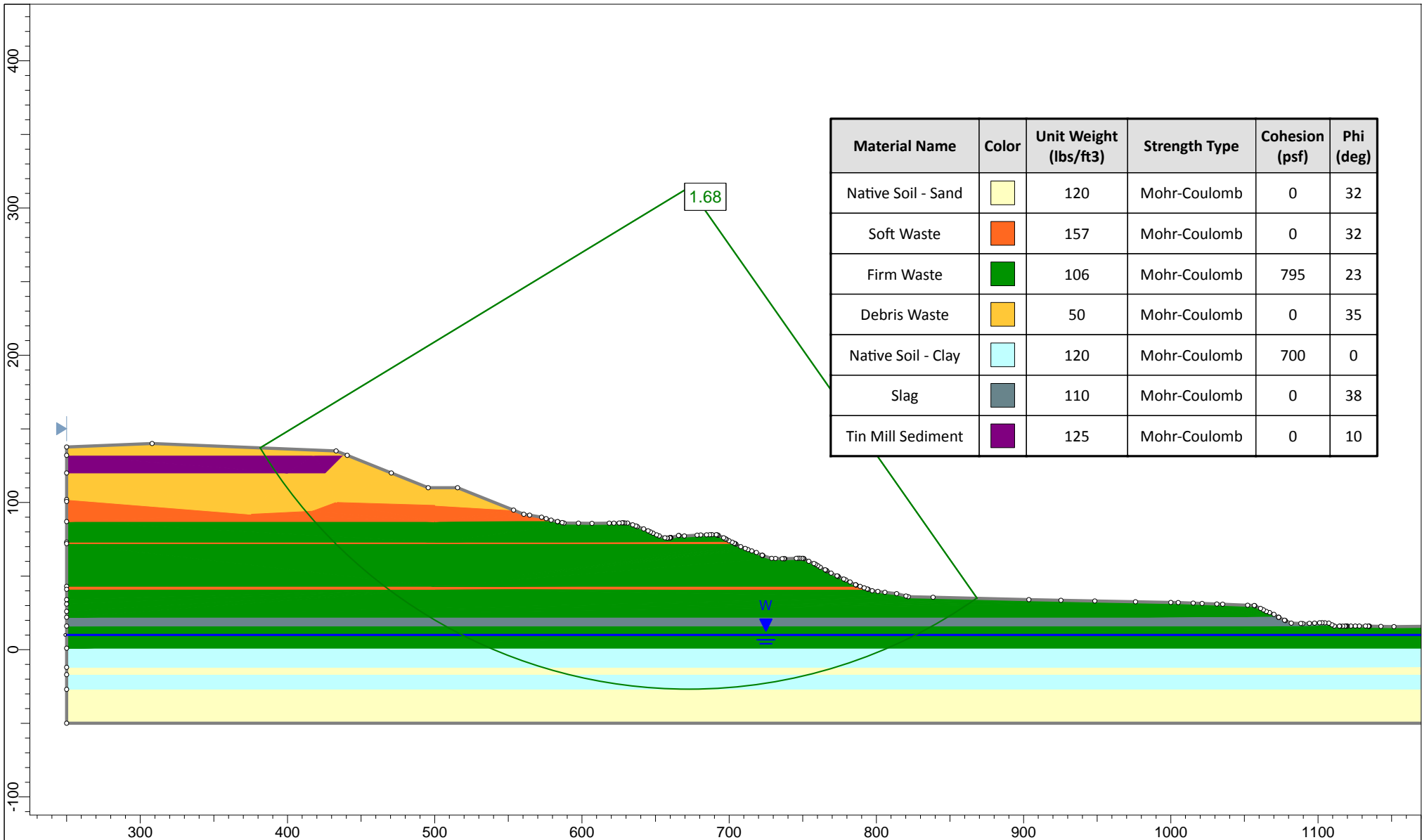

	<b>Project</b> Greys Landfill Stability Analysis		
	<b>Analysis Description</b> Section 4	<b>Circular</b>	<b>Static</b>
	<b>Drawn By</b> BSA	<b>Scale</b> 1:1100	<b>Company</b> ARM Group Inc.
	<b>Date</b> 10/11/17		<b>File Name</b> Section 4_circular.sli

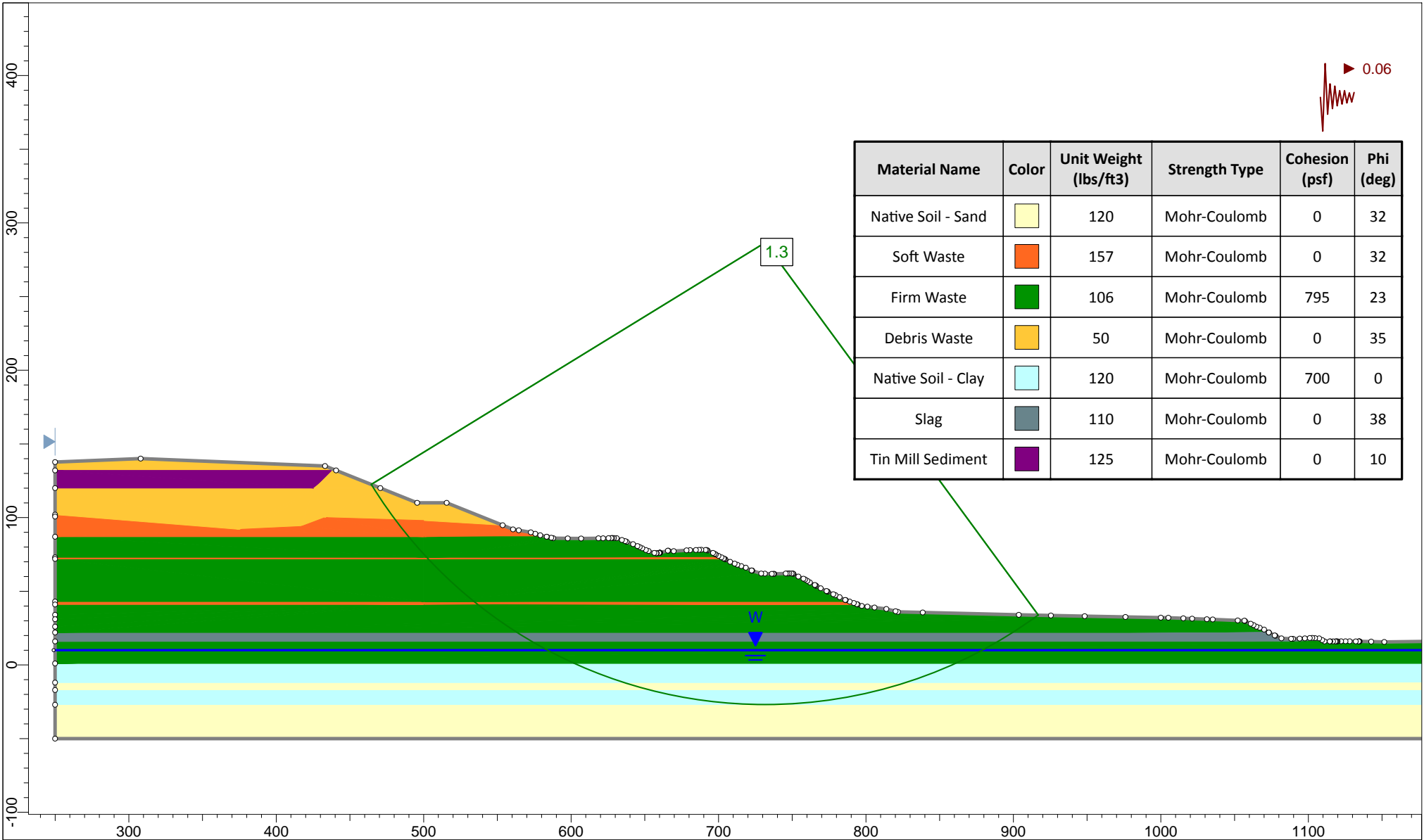

Material Name	Color	Unit Weight (lbs/ft3)	Strength Type	Cohesion (psf)	Phi (deg)
Native Soil - Sand	Yellow	120	Mohr-Coulomb	0	32
Soft Waste	Orange	157	Mohr-Coulomb	0	32
Firm Waste	Green	106	Mohr-Coulomb	795	23
Debris Waste	Light Orange	50	Mohr-Coulomb	0	35
Native Soil - Clay	Light Blue	120	Mohr-Coulomb	700	0
Slag	Grey	110	Mohr-Coulomb	0	38
Tin Mill Sediment	Purple	125	Mohr-Coulomb	0	10



<i>Project</i>				Greys Landfill Stability Analysis	
<i>Analysis Description</i>		Section 4		Circular	
<i>Drawn By</i>		BSA		<i>Scale</i> 1:1100	
<i>Date</i>		10/11/17		<i>Company</i> ARM Group Inc.	
				<i>File Name</i> Section 4_circular_seismic.sli	

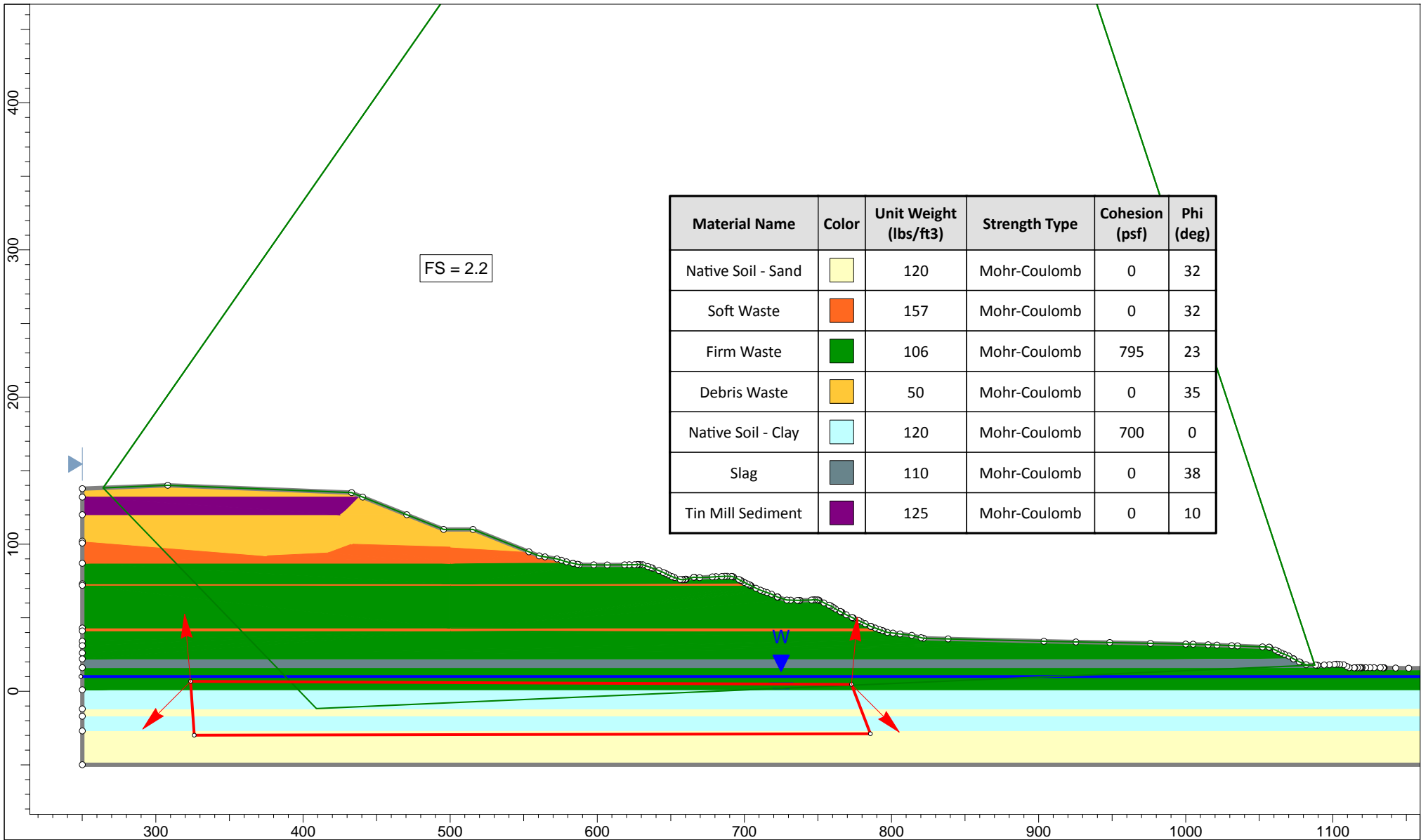

FS = 2.2

Material Name	Color	Unit Weight (lbs/ft <sup>3</sup> )	Strength Type	Cohesion (psf)	Phi (deg)
Native Soil - Sand		120	Mohr-Coulomb	0	32
Soft Waste		157	Mohr-Coulomb	0	32
Firm Waste		106	Mohr-Coulomb	795	23
Debris Waste		50	Mohr-Coulomb	0	35
Native Soil - Clay		120	Mohr-Coulomb	700	0
Slag		110	Mohr-Coulomb	0	38
Tin Mill Sediment		125	Mohr-Coulomb	0	10



<i>Project</i>				Greys Landfill Stability Analysis	
<i>Analysis Description</i>		Section 4		Translational	
<i>Drawn By</i>		BSA		Static	
<i>Date</i>		10/11/17		<i>Scale</i>	
		1:1100		<i>Company</i>	
				ARM Group Inc.	
				<i>File Name</i>	
				Section 4_translational.sli	

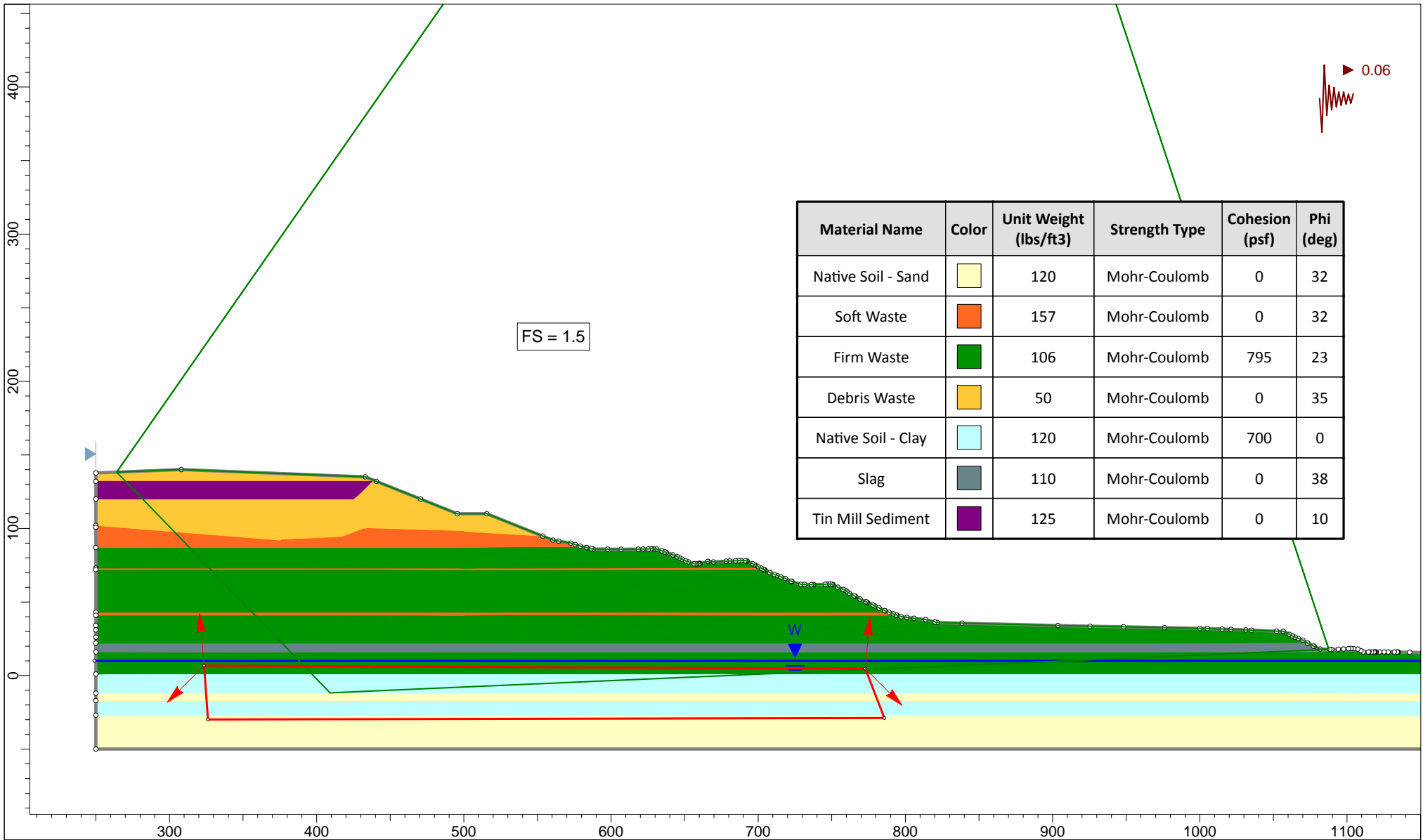

Material Name	Color	Unit Weight (lbs/ft <sup>3</sup> )	Strength Type	Cohesion (psf)	Phi (deg)
Native Soil - Sand		120	Mohr-Coulomb	0	32
Soft Waste		157	Mohr-Coulomb	0	32
Firm Waste		106	Mohr-Coulomb	795	23
Debris Waste		50	Mohr-Coulomb	0	35
Native Soil - Clay		120	Mohr-Coulomb	700	0
Slag		110	Mohr-Coulomb	0	38
Tin Mill Sediment		125	Mohr-Coulomb	0	10



<i>Project</i>				Greys Landfill Stability Analysis	
<i>Analysis Description</i>		Section 4		Translational	
<i>Drawn By</i>		BSA		<i>Company</i>	
<i>Date</i>		10/11/17		<i>File Name</i>	
		<i>Scale</i>		ARM Group Inc.	
		1:1100		Section 4_translational_seismic.sli	

---

---

**APPENDIX C**

**Project Authorizations**

---

---



**STATE OF MARYLAND**  
**DEPARTMENT OF THE ENVIRONMENT**  
**WATER AND SCIENCE ADMINISTRATION**  
**AUTHORIZATION TO PROCEED**

AUTHORIZATION NUMBER: 201761238/17-NT-0260

EFFECTIVE DATE: August 9, 2017

EXPIRATION DATE: August 9, 2022

AUTHORIZED PERSON: Sparrows Point Terminal, LLC  
1600 Sparrows Point Boulevard  
Sparrows Point, Maryland 21219  
Attn: Peter Hard



IN ACCORDANCE WITH ENVIRONMENT ARTICLE §5-503(a) AND §5-906(b), ANNOTATED CODE OF MARYLAND (2007 REPLACEMENT VOLUME), COMAR 26.17.04 AND 26.23.01, AND 26.08.02 AND THE ATTACHED CONDITIONS OF AUTHORIZATIONS, Sparrows Point Terminal, LLC ("AUTHORIZED PERSON"), IS HEREBY AUTHORIZED BY THE WATER AND SCIENCE ADMINISTRATION ("ADMINISTRATION") TO CONDUCT A REGULATED ACTIVITY IN A NONTIDAL WETLAND, BUFFER, OR EXPANDED BUFFER, AND/OR TO CHANGE THE COURSE, CURRENT OR CROSS-SECTION OF WATERS OF THE STATE, IN ACCORDANCE WITH THE ATTACHED PLANS APPROVED BY THE ADMINISTRATION ON August 9, 2017 ("APPROVED PLAN") AND PREPARED BY EnviroAnalytics Group AND INCORPORATED HEREIN, AS DESCRIBED BELOW:

The project involves the repair of Tin Mill Canal through the removal of accumulated sediment to restore the original flow capacity. The project will also include removal of existing, abandoned utilities, oil-removal stations, fences, canal crossing man ways, inactive outfalls and other features non-needed features along the canal. The project will temporarily impact 7,500 linear feet (280,000 square feet) of stream. The project is location is 1600 Sparrows Point Boulevard, Sparrows Point in Baltimore County.

MD Grid Coordinates 174309 x 446030

A handwritten signature in blue ink, appearing to read "Denise M. Keehner", written over a horizontal line.

Denise M. Keehner  
Program Manager  
Wetlands and Waterways Program

Attachments: Conditions of Authorization  
Approved Plans

cc: WSA Compliance Division w/ file  
James Calenda, EnviroAnalytics Group  
Maria Teresi, ACOE

THE FOLLOWING CONDITIONS OF AUTHORIZATION APPLY TO ALL ACTIVITIES AUTHORIZED BY  
AUTHORIZATION NUMBER 17-NT-0260/201761238

Page 2 of 3

1. **Validity:** Authorization is valid only for use by Authorized Person. Authorization may be transferred only with prior written approval of the Administration. In the event of transfer, transferee agrees to comply with all terms and conditions of Authorization.
2. **Initiation of Work, Modifications and Extension of Term:** Authorized Person shall initiate authorized activities with two (2) years of the Effective Date of this Authorization or the Authorization shall expire. Authorized Person may submit written requests to the Administration for (a) extension of the period for initiation of work, (b) modification of Authorization, including the Approved Plan, or, (c) not later than 45 days prior to Expiration Date, an extension of the term. Requests for modification shall be in accordance with applicable regulations and shall state reasons for changes, and shall indicate the impacts on nontidal wetlands, streams, and the floodplain, as applicable. The Administration may grant a request at its sole discretion.
3. **Responsibility and Compliance:** Authorized Person is fully responsible for all work performed and activities authorized by this Authorization shall be performed in compliance with this Authorization and Approved Plan. Authorized Person agrees that a copy of the Authorization and Approved Plan shall be kept at the construction site and provided to its employees, agents and contractors. A person (including Authorized Person, its employees, agents or contractors) who violates or fails to comply with the terms and conditions of this Authorization, Approved Plan or an administrative order may be subject to penalties in accordance with §5-514 and §5-911, Department of the Environment Article, Annotated Code of Maryland (2007 Replacement Volume).
4. **Failure to Comply:** If Authorized Person, its employees, agents or contractors fail to comply with this Authorization or Approved Plan, the Administration may, in its discretion, issue an administrative order requiring Authorized Person, its employees, agents and contractors to cease and desist any activities which violate this Authorization, or the Administration may take any other enforcement action available to it by law, including filing civil or criminal charges.
5. **Suspension or Revocation:** Authorization may be suspended or revoked by the Administration, after notice of opportunity for a hearing, if Authorized Person: (a) submits false or inaccurate information in Permit application or subsequently required submittals; (b) deviates from the Approved Plan, specifications, terms and conditions; (c) violates, or is about to violate terms and conditions of this Authorization; (d) violates, or is about to violate, any regulation promulgated pursuant to Title 5, Department of the Environment Article, Annotated Code of Maryland as amended; (e) fails to allow authorized representatives of the Administration to enter the site of authorized activities at any reasonable time to conduct inspections and evaluations; (f) fails to comply with the requirements of an administrative action or order issued by the Administration; or (g) does not have vested rights under this Authorization and new information, changes in site conditions, or amended regulatory requirements necessitate revocation or suspension.
6. **Other Approvals:** Authorization does not authorize any injury to private property, any invasion of rights, or any infringement of federal, State or local laws or regulations, nor does it obviate the need to obtain required authorizations or approvals from other State, federal or local agencies as required by law.
7. **Site Access:** Authorized Person shall allow authorized representatives of the Administration access to the site of authorized activities during normal business hours to conduct inspections and evaluations necessary to assure compliance with this Authorization. Authorized Person shall provide necessary assistance to effectively and safely conduct such inspections and evaluations.
8. **Inspection Notification:** Authorized Person shall notify the Administration's Compliance Program at least five (5) days before starting authorized activities and five (5) days after completion. For Allegany, Garrett, and Washington counties, Authorized Person shall call 301-689-1480. For Carroll, Frederick, Howard, Montgomery, and Prince George's counties, Authorized Person shall call 301-665-2850. For Baltimore City, Anne Arundel, Baltimore, Calvert, Charles, and St. Mary's, Authorized Person shall call 410-537-3510. For Caroline, Cecil, Dorchester, Harford, Kent, Queen Anne's, Somerset, Talbot, Wicomico and Worcester, Authorized Person shall call 410-901-4020. If Authorization is for a project that is part of a mining site, please contact the Land and Materials Administration's Mining Program at 410-537-3557 at least five (5) days before starting authorized activities and five (5) days after completion.
9. **Sediment Control:** Authorized Person shall obtain approval from the Baltimore Soil Conservation District for a grading and sediment control plan specifying soil erosion control measures. The approved grading and sediment control plan shall be included in the Approved Plan, and shall be available at the construction site.

**10. Federally Mandated State Authorizations:**

**Water Quality Certification:** Water Quality Certification is granted for this project provided that all work is performed in accordance with the authorized project description and associated conditions.

**Coastal Zone Consistency:** This Authorization constitutes official notification that authorized activities are consistent with the Maryland Coastal Zone Management Program, as required by Section 307 of the Federal Coastal Zone Management Act of 1972, as amended. Activities within the following counties are not subject to this requirement: Allegany, Carroll, Frederick, Garrett, Howard, Montgomery, and Washington.

11. **Best Management Practices During Construction:** Authorized Person, its employees, agents and contractors shall conduct authorized activities in a manner consistent with the Best Management Practices specified by the Administration.
12. **Disposal of Excess:** Unless otherwise shown on the Approved Plan, all excess fill, spoil material, debris, and construction material shall be disposed of outside of nontidal wetlands, nontidal wetlands buffers, and the 100-year floodplain, and in a location and manner which does not adversely impact surface or subsurface water flow into or out of nontidal wetlands.
13. **Temporary Staging Areas:** Temporary construction trailers or structures, staging areas and stockpiles shall not be located within nontidal wetlands, nontidal wetlands buffers, or the 100-year floodplain unless specifically included on the Approved Plan.
14. **Temporary Stream Access Crossings:** Temporary stream access crossings shall not be constructed or utilized unless shown on the Approved Plan. If temporary stream access crossings are determined necessary prior to initiation of work or at any time during construction, Authorized Person, its employees, agents or contractors shall submit a written request to the Administration and secure the necessary permits or approvals for such crossings before installation of the crossings. Temporary stream access crossings shall be removed and the disturbance stabilized prior to completion of authorized activity or within one (1) year of installation.
15. **Discharge:** Runoff or accumulated water containing sediment or other suspended materials shall not be discharged into waters of the State unless treated by an approved sediment control device or structure.
16. **Instream Construction Prohibition:**
  - No instream construction is to occur under this Authorization;
  - To protect important aquatic species, motor driven construction equipment shall not be allowed within stream channels unless on authorized ford crossings. Activities within stream channels are prohibited as determined by the classification of the stream (COMAR 26.08.02.08): Un-named tributary to Bear Creek is a Use I waterway; in-stream work may not be conducted from March 01 through June 15 inclusive, of any year.
17. **Instream Blasting:** Authorized Person shall obtain prior written approval from the Administration before blasting or using explosives in the stream channel.
18. **Minimum Disturbance:** Any disturbance of stream banks, channel bottom, wetlands, and wetlands buffer authorized by this Authorization or Approved Plan shall be the minimum necessary to conduct permitted activities. All disturbed areas shall be stabilized vegetatively no later than seven (7) days after construction is completed or in accordance with the approved grading or sediment and erosion control plan.
19. **Restoration of Construction Site:** Authorized Person shall restore the construction site upon completion of authorized activities. Undercutting, meandering or degradation of the stream banks or channel bottom, any deposition of sediment or other materials, and any alteration of wetland vegetation, soils, or hydrology, resulting directly or indirectly from construction or authorized activities, shall be corrected by Authorized Person as directed by the Administration.

**U.S. ARMY CORPS OF ENGINEERS AUTHORIZATION**

The U.S. Army Corps of Engineers has reviewed this activity and has granted authorization under the Maryland State Programmatic General Permit (MDSPGP-5), as a Category B activity. The federal authorization will be sent separately by the Army Corps of Engineers.



DEPARTMENT OF THE ARMY  
BALTIMORE DISTRICT, CORPS OF ENGINEERS  
ATTN: REGULATORY BRANCH  
10 S. HOWARD STREET  
BALTIMORE, MD 21201

NOV 22 2017

Operations Division

Mr. Peter Haid  
Tradepoint Atlantic  
1600 Sparrows Point Boulevard  
Baltimore, Maryland 21219

Dear Mr. Haid:

This is in reference to your application, **NAB-2017-61238-M07 (TRADEPOINT ATLANTIC)**, received on June 8, 2017, for Department of Army (DA) authorization to remove accumulated sediment, restore flow capacity, and install a geotextile cap to support future stormwater conveyance within the Tin Mill Canal, Sparrows Point, Baltimore County, Maryland.

Your application indicated that you will be mechanically excavating the sediment and discharging it into an approved upland containment area via a Consent Decree under Section 3008(h) of the Resource Conservation and Recovery Act, 42 U.S.C. 6928(h) between the Maryland Department of the Environment and the United States Environmental Protection Agency. Our evaluation has determined that the proposed work, if accomplished in accordance with the description within the application, does not require a Department of Army authorization pursuant to Section 404 of the Clean Water Act. If any of the information contained in the application and/or plan(s) is later found to be in error, this determination may be subject to modification, suspension, or revocation.

If you have any questions concerning this matter, please call the undersigned at (410) 962-4501.

Sincerely,

A handwritten signature in cursive script that reads "Maria N. Teresi".

Maria N. Teresi  
Project Manager, Maryland Section Northern

cc: Mr. Phatta Thapa, MDE Waterways Division (via email)  
Mrs. Cheryl Kerr, MDE Nontidal Wetlands Division (via email)  
Mr. James Calenda, EnviroAnalytics Group (via email)

---

To identify how we can better serve you, we need your help. Please take the time to fill out our new customer service survey at:  
[http://corpsmapu.usace.army.mil/cm\\_apex/f?p=136:4:8845707609835](http://corpsmapu.usace.army.mil/cm_apex/f?p=136:4:8845707609835)





KEVIN KAMENETZ  
*County Executive*

VINCENT J. GARDINA, *Director*  
*Department of Environmental Protection*  
*and Sustainability*

Stormwater Management

410-887-3768

November 17, 2017

T. Niel Peters, P.E.  
ARM Group Inc.  
9175 Guilford Road, Suite 310  
Columbia, MD 21046

RE: Tin Mill Canal Maintenance  
Trade Point Atlantic  
Stormwater Management Variance  
Baltimore Harbor Watershed  
**EPS Project I.D. M170361**  
**EPS Tracking Number: 07-17-2606**

Dear Mr. Peters:

This office has reviewed the information submitted and finds that a stormwater management variance can be granted for this project under Section 33-4-113 (a) (2) of Title 4 of the Baltimore County Code. This section of the regulations allows a stormwater management variance to be granted if there are exceptional circumstances such that strict adherence to the provisions of this article would result in unreasonable hardship or practical difficulty and not fulfill the intent of the regulations.

This project is for clean-up of the Tin Mill canal. The existing cover conditions will be reestablished once the project is completed. Although the disturbed area is in excess of 5,000 square feet, there will be no increase in impervious area or runoff as a result of this project.

Please contact Michael P. Doyle of my staff at 410-887-3768 should you have any questions.

Very truly yours,

A handwritten signature in black ink that reads "J. Markle".

James A. Markle, P.E., Manager  
Department of Environmental Protection  
& Sustainability

JAM:jcm

c: Michael P. Doyle



**Maryland**  
Department of  
the Environment

Larry Hogan, Governor  
Boyd K. Rutherford, Lt. Governor

Ben Grumbles, Secretary  
Horacio Tablada, Deputy Secretary

November 22, 2017

Ms. Barbara Kernan, Chief of Staff  
Baltimore County Permits  
Approvals and Inspections  
111 West Chesapeake Avenue  
Towson, MD 21204

Re: **MDE No. 18-SF-0078**  
**AI: 157635**  
**Tradepoint Atlantic LLC**  
**Tin Mill Canal Maintenance Dredging**

Dear Ms. Kernan:

The Maryland Department of the Environment (MDE) has reviewed the submittal received from Tradepoint Atlantic on November 16, 2017 for the above referenced project located in Sparrows Point, Maryland. The review was in accordance with Section 4-105 of the Environment Article, Annotated Code of Maryland with regard to sediment control.

As a result of the review it has been determined that no erosion and sediment controls beyond the requirements set forth by MDE Land and Materials Administration are needed for this dredging project.

Please call me at (410) 537-3551 with any questions or comments.

Sincerely,

A handwritten signature in black ink, appearing to read "Amanda Malcolm".

Amanda P. Malcolm, P.E., Chief  
Sediment and Stormwater Plan Review Division  
Water Management Administration

APM/DTL/MDEH

cc: approval file

Mr. James A. Markle, P.E., Manager Stormwater Management (via email)  
Mr. Jan Cook, Development Manager, Baltimore County  
Mr. Justin Dunn, Tradepoint Atlantic LLC (via email)

---

---

**APPENDIX D**

**Landfill Berm Information**

---

---

### **Greys Landfill Berm Information**

Soils and waste materials have been placed and compacted into Greys Landfill over time in accordance with the Greys Landfill Facility Operations Manual (February 20, 2015).

In anticipation of the Tin Mill Canal maintenance cleanup activities (i.e., sediment removal plans), a soil containment berm has been constructed at the top of the landfill to help delineate the area within which the excavated, dewatered, and approved materials will be placed, and to help contain the materials. The location of the berm is shown on Sheet 4 of the TMC Maintenance Cleanup Plan drawings.

The berm was constructed from potentially contaminated soils removed from various excavations across the Sparrows Point project site, and clean fill from the soil borrow area. The materials were placed in lifts and compacted to a firm condition with the on-site construction equipment (i.e., bulldozer).

On November 20, 2017, an ARM representative inspected the sediment cell, took measurements of the earthen containment berm, and took photographs of the berm conditions. The measured dimensions of the cell are as follows, and selected photographs are attached:

- Northern berm: 450 feet long, interior slope is 20 feet, exterior slope is 50 feet, top of the berm is 16 feet wide
- Eastern berm: 335 feet long, interior slope is 20 feet, exterior slope is 50 feet, top of the berm is 80 feet wide
- Southern berm: 700 feet long, interior slope is 20 feet, exterior slope is 35 feet, top of berm is 16 feet wide



Tin Mill Canal Sediment Cell  
Greys Landfill  
Sparrows Point, Maryland



Photo 1: View of the cell facing east.



Photo 2: View of the cell facing west.



Tin Mill Canal Sediment Cell  
Greys Landfill  
Sparrows Point, Maryland



Photo 3: View of the exterior face of the northern berm facing east.



Photo 4: View of the exterior face of the eastern berm facing south.



Tin Mill Canal Sediment Cell  
Greys Landfill  
Sparrows Point, Maryland



Photo 5: View of the exterior face of the southern berm facing east.



Photo 6: View of the interior face of the eastern berm facing east.



Tin Mill Canal Sediment Cell  
Greys Landfill  
Sparrows Point, Maryland



Photo 7: View of the top of the eastern berm facing north.



Photo 8: View of the interior face of the southern berm facing east.

---

---

**APPENDIX E**

**TMC Sediment TCLP Information**

---

---



**TCLP Information Excerpted from  
“Tin Mill Canal Sediment Characterization Report”  
Revision 2 – November 15, 2017**

### **3.3 SAMPLING LOCATIONS**

Sediment samples were collected from 16 transects along the length of the TMC and from 1 transect along the channelway from the Pori Lagoon area. Transect locations and numbers are shown on **Figure 2**. Samples were collected at each transect in accordance with the following plan:

- Discrete depth samples: The width of the sediment horizon was measured at each transect location. Depth of sediment to the slag bottom of the canal was measured at two locations that represent distances of one third and two thirds across the perpendicular width of the sediment horizon. At each of these two locations, a sediment sample was collected from the top foot of the sediment horizon (shallow discrete sample) and another sample was collected from the bottom foot of the sediment horizon (deep discrete sample). At some locations, there was not sufficient recovery of sediment to be able to collect both a shallow and a deep discrete sample. In total, 58 discrete depth samples were collected and analyzed for specific Appendix IX volatile organic compounds (VOCs), Appendix IX RCRA metals including hexavalent chromium, and for Toxicity Characteristic Leaching Procedure (TCLP) VOCs.
  
- Composite samples: For each transect, sediment from the two aforementioned shallow discrete samples was thoroughly mixed to produce a shallow composite sample, and sediment from the two deep discrete samples was thoroughly mixed to produce a deep composite sample. An “(S)” was added to the end of the sample IDs for the shallow composite samples and a “(D)” was added to the end of the sample IDs for the deep composite samples. In total, 29 composite samples were collected and analyzed for specific Appendix IX semi-volatile organic compounds (SVOCs), cyanide, polychlorinated biphenyl (PCB) aroclors, TCLP SVOCs, and TCLP inorganics.

### **3.4 SAMPLE COLLECTION PROCEDURE**

A modified surge block sampling apparatus (suction sampler) was used to collect the sediment samples. The suction sampler consisted of a 2-inch diameter PVC pipe, the surge block (a piece of rubber between two 1 7/8-inch diameter washers), and a 1-inch diameter PVC pipe. The surge block was attached to the end of the 1-inch PVC pipe and secured in place with a nut. As the nut is tightened, the rubber is squeezed outward from between the washers. When the surge block is

pushed into the 2-inch PVC pipe, the rubber between the washers creates a seal around the inside of the pipe.

To collect a sample, the suction sampler was driven downward into soft sediment, with the surge block at the bottom of the 2-inch PVC pipe, until the required sampling depth was achieved. Once at the desired sampling depth, the apparatus was withdrawn for one foot, then lowered back down one foot while pulling the surge block up through the interior of the 2-inch pipe. This process pulled the soft sediment into the sampler. The suction sampler was then extracted from the soft sediment, tilting it as the bottom reached surface grade. Sample material was then recovered out of the sampler into a plastic bag and distributed as required to sample containers.

Wide-mouth glass containers with Teflon-lined caps were utilized for sample containers. Sediment was transferred from plastic bags to sample containers using a stainless steel or plastic lab spoon or equivalent. For composite samples, recovered sediment was placed into a stainless steel, plastic or other appropriate composition (e.g.: Teflon) bucket and mixed thoroughly to obtain a homogeneous sample. The sediment samples were placed into labeled containers. Samples were preserved to 4 degrees Celsius immediately after recovery.

All sampling devices and non-disposable equipment that came into contact with sediment were decontaminated prior to reuse. Decontamination procedures included:

- Wash with a laboratory grade detergent, such as Alconox
- Rinse with distilled water
- Second rinse with distilled water

## **6.0 REMEDIATION WASTE CHARACTERIZATION**

The analytic testing data reported by the laboratory for the collected samples was assessed in a stepwise manner to determine if the sediments removed from the TMC will be subject to regulation as hazardous waste under RCRA. The sediments removed from the canal are defined as remediation wastes in 40 CFR 260.10 or more specifically as contaminated environmental media. Contaminated environmental media generally is not subject to regulation under RCRA but may be subject to regulation if the media “contain” hazardous waste. Because of the varying nature of the sources of constituents in the canal and the potential that the media may have been contaminated with listed hazardous waste, the stepwise approach included the following procedures to identify the potential presence of hazardous remediation waste:

- 1) Evaluation of toxicity characteristics of hazardous waste (TCLP testing);

- 2) Evaluation of the concentration of hazardous constituents and whether the constituents exist at concentrations greater than health-based levels calculated using a reasonable maximum exposure scenario for the remedial activity;

### **6.1 RCRA TOXICITY CHARACTERISTIC ASSESSMENT**

A representative number of samples of sediment from the TMC were analyzed using the Toxicity Characteristic Leaching Procedure (TCLP). Analytical results for toxicity characteristic testing of the sediments are summarized in **Table 3**. TCLP testing was completed for regulated volatile, semi-volatile and metal constituents of discrete and composite sediment samples recovered from all transects. As summarized in **Table 3**, no exceedances of the TCLP regulatory limits were identified; therefore it has been demonstrated that the contaminated environmental media that will be excavated/dredged from the canal will not exhibit a hazardous characteristic.

### **6.2 RCRA CONTAINED-IN WASTE ASSESSMENT**

Based on the historical records, the sediment currently present in the TMC may have contacted and been contaminated with wastewater treatment sludges from electroplating operations, a listed hazardous waste (EPA Waste Code F006), prior to the installation of a separate wastewater treatment facility (HDS plant) in 1987. Spent pickle liquor, which was beneficially reused to adjust pH in the TMC, is also a listed hazardous waste (K062) when disposed rather than reused. Thus, under EPA's "contained-in" policy, sediment excavated from the TMC could be considered contaminated media and could be subject to regulation under RCRA if determined to "contain" hazardous waste. EPA generally considers contaminated environmental media to contain hazardous waste: (1) when they exhibit a characteristic of hazardous waste; or, (2) when they are contaminated with concentrations of hazardous constituents from listed hazardous waste that are above health-based levels.

If contaminated environmental media contain hazardous waste, they are subject to all applicable RCRA requirements until they no longer contain hazardous waste. EPA considers contaminated environmental media to no longer contain hazardous waste: (1) when they no longer exhibit a characteristic of hazardous waste; and (2) when concentrations of hazardous constituents from listed hazardous wastes are below health-based levels.

In the case of environmental media that are contaminated by listed hazardous waste, EPA guidance recommends that "contained-in" determinations be made based on health-based levels of hazardous constituents below which contaminated environmental media would be considered to no longer contain hazardous waste. Since this determination involves development of site-specific health-based levels, the approval of EPA or an authorized state is required. In this case, MDE has been delegated the authority to make the determination of when the sediments no longer contain hazardous waste. In an email dated February 4, 2016 (**Appendix A**), MDE determined that for the Tin Mill Canal remediation waste to be considered to no longer contain

hazardous waste, the characterization of the remediation waste must demonstrate that: (1) the waste no longer exhibits any characteristics of a hazardous waste; and (2) the concentrations of constituents are below the USEPA industrial soil Regional Screening Levels (RSLs) set to a hazard index of 10 and a cancer risk of  $1 \times 10^{-4}$  (Adjusted RSLs).

As discussed above, in order for contaminated environmental media to no longer contain hazardous waste, it must first no longer exhibit a characteristic of hazardous waste. The TMC sediments were tested for the toxicity characteristic via TCLP methods. The results of the TCLP testing are presented in **Table 3**. In this table, the results of the TCLP tests are compared to the regulatory criteria established to define a waste as characteristically hazardous under RCRA due to toxicity. As indicated, none of the regulatory criteria were exceeded. Therefore, the sediments do not exhibit the characteristic of hazardous waste.

## **8.2 REMEDIATION WASTE CHARACTERIZATION**

TCLP testing of discrete and composite sediment samples recovered from all transects was completed for regulated volatile, semi-volatile and metal constituents. No exceedances of the TCLP regulatory limits were identified. Furthermore, none of the maximum detected concentrations or maximum MDLs for all hazardous constituents (except PCBs) exceeded their respective health-based levels below which contaminated environmental media would be considered to no longer contain hazardous waste (“contained-in” criteria i.e., Adjusted RSLs). Therefore, with the exception of sediment with concentrations of PCBs greater than 50 mg/kg, the contaminated environmental media that will be excavated/dredged from the canal will be considered “contained out” and will not require management as a hazardous waste.

Sediments or contaminated media containing total PCB concentrations greater than 50 mg/kg are subject to requirements under TSCA. Therefore, material with total PCB concentrations greater than 50 mg/kg will be excavated and segregated for transport and disposal off-site to a permitted hazardous waste landfill approved to accept TSCA-regulated waste.

The sediments contain high moisture content and exhibit the presence of free liquids. Dewatering and stabilization will be required prior to disposal in the on-site Greys landfill or transport off-site to a permitted hazardous waste landfill approved to accept TSCA-regulated waste. Bench or field testing should be conducted to determine an appropriate sorbent agent and the appropriate dewatering, dosing and mixing methods to eliminate free liquids and achieve a consistency suitable for transport and disposal.

### **Attachments:**

- Sample Location Map (Figure 2)
- TCLP Summary Table (Table 3)



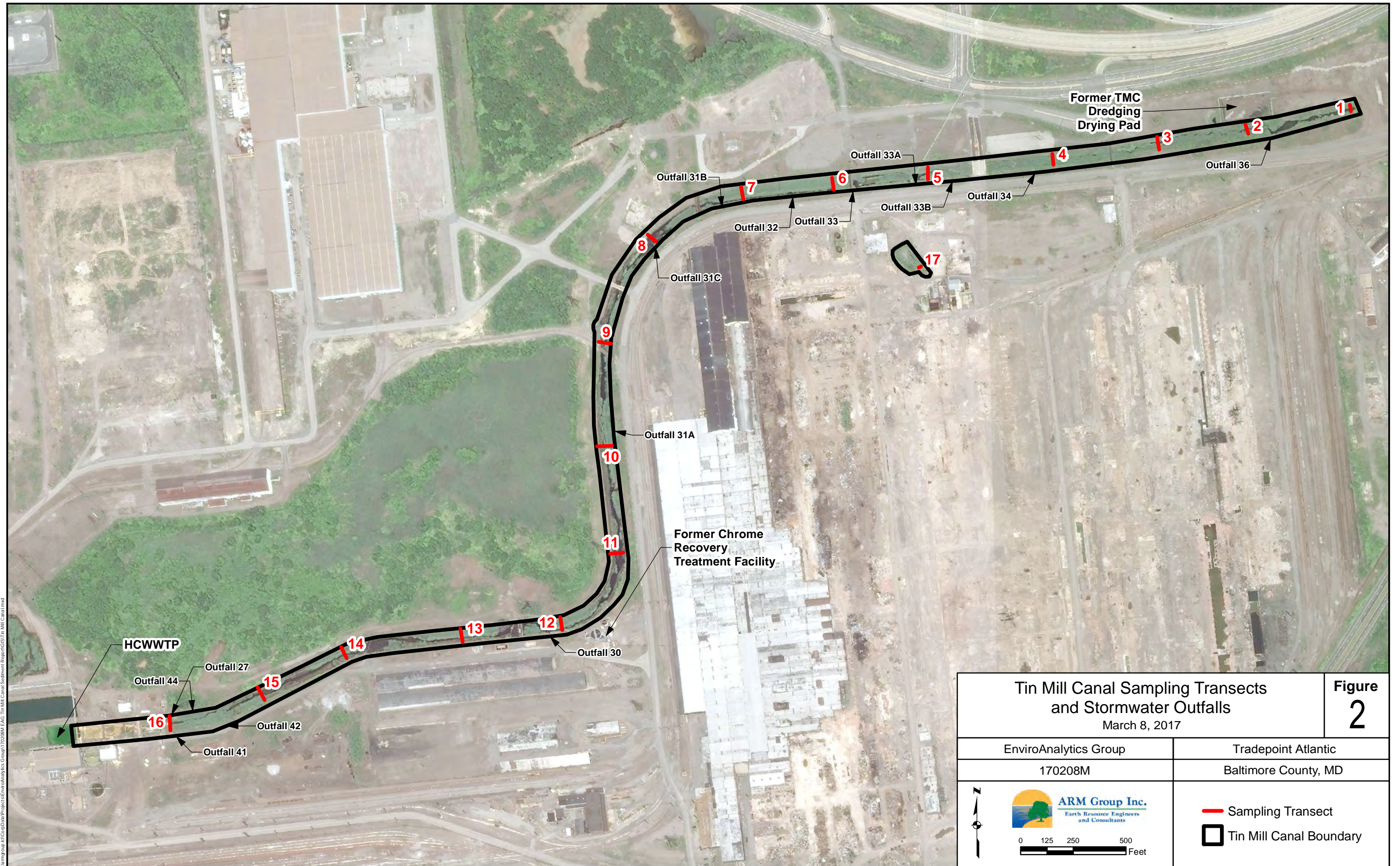

Working File: C:\Data\Projects\EnviroAnalytics Group\170208M EAG Tin Mill Canal Sediment Report\GIS\Tin Mill Canal.mxd



<b>Tin Mill Canal Sampling Transects and Stormwater Outfalls</b> March 8, 2017		<b>Figure 2</b>
EnviroAnalytics Group 170208M	Tradepoint Atlantic Baltimore County, MD	
 <b>ARM Group Inc.</b> Earth Resource Engineers and Consultants		
 		



Table 3 - TCLP Test Results

TIN MILL CANAL TCLP TEST RESULTS			Transect 1			Transect 2			
			TM-SD-01	TM-SD-03	TM-SD-05	TM-SD-06	TM-SD-07	TM-SD-08	TM-SD-09
Sample Identification			4/14/2015	4/14/2015	4/14/2015	4/14/2015	4/14/2015	4/14/2015	4/14/2015
Sample Date			Discrete	Discrete	Composite	Discrete	Discrete	Discrete	Discrete
Sample Type			South 0-6"	North 0-6"	0-6"	South 0-12"	South 4-5'	North 0-12"	North 4-5'
Sample Location and Depth									
Compound	Regulatory Level	Units							
<b>TCLP VOC</b>									
1,1-Dichloroethene	0.7	mg/L	0.05 U	0.05 U		0.05 U	0.05 U	0.05 U	0.05 U
1,2-Dichloroethane	0.5	mg/L	0.05 U	0.05 U		0.05 U	0.05 U	0.05 U	0.05 U
2-Butanone (MEK)	200.0	mg/L	5 U	5 U		5 U	0.0317 J	5 U	5 U
Benzene	0.5	mg/L	0.05 U	0.05 U		0.05 U	0.05 U	0.05 U	0.05 U
Carbon tetrachloride	0.5	mg/L	0.05 UJ	0.05 UJ		0.05 UJ	0.05 UJ	0.05 UJ	0.05 UJ
Chlorobenzene	100.0	mg/L	0.0064 J	1 U		1 U	1 U	1 U	1 U
Chloroform	6.0	mg/L	0.0038 J	0.0042 J		0.0037 J	0.0053 B	0.0034 J	0.0052 B
Tetrachloroethene	0.7	mg/L	0.05 U	0.05 U		0.05 U	0.05 U	0.05 U	0.05 U
Trichloroethene	0.5	mg/L	0.05 U	0.05 U		0.05 U	0.05 U	0.05 U	0.05 U
Vinyl chloride	0.2	mg/L	0.05 U	0.05 U		0.05 U	0.05 U	0.05 U	0.05 U
<b>TCLP Metals</b>									
Arsenic	5.0	mg/L			0.01 J				0.012 J
Barium	100.0	mg/L			0.45 J				2.1
Cadmium	1.0	mg/L			0.00079 J				0.00087 J
Chromium	5.0	mg/L			0.0023 J				0.0016 J
Lead	5.0	mg/L			0.05 U				0.05 U
Selenium	1.0	mg/L			0.013 J				0.015 J
Silver	5.0	mg/L			0.0022 J				0.001 J
Mercury	0.2	mg/L			0.001 U				0.001 U
<b>TCLP SVOC</b>									
1,4-Dichlorobenzene	7.5	mg/L			0.5 RR				0.5 RR
2,4,5-Trichlorophenol	400.0	mg/L			5 RR				5 RR
2,4,6-Trichlorophenol	2.0	mg/L			0.1 RR				0.1 RR
2,4-Dinitrotoluene	0.13	mg/L			0.1 RR				0.1 RR
2-Methylphenol(o-Cresol)	200.0	mg/L			2 RR				2 RR
3&4-Methylphenol(m&p Cresol)	200.0	mg/L			2 RR				2 RR
Hexachloro-1,3-butadiene	0.5	mg/L			0.1 RR				0.1 RR
Hexachlorobenzene	0.13	mg/L			0.1 RR				0.1 RR
Hexachloroethane	3.0	mg/L			0.5 RR				0.5 RR
Nitrobenzene	2.0	mg/L			0.1 RR				0.1 RR
Pentachlorophenol	100.0	mg/L			5 RR				5 RR
Pyridine	5.0	mg/L			0.5 RR				0.5 RR

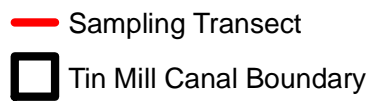
**Data Validation Qualifier Code**

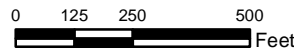
- J** - The positive result reported for this analyte is a quantitative estimate.
- J+** - The positive result reported for this analyte is a quantitative estimate, but may be biased high.
- J-** - The positive result reported for this analyte is a quantitative estimate, but may be biased low.
- B** - The compound/analyte was not detected substantially above the level of the associated method blank/preparation or field blank
- U** - This analyte was not detected in the sample. The numeric value represents the sample quantitation/detection limit.
- UJ** - This analyte was not detected in the sample. The actual quantitation/detection limit may be higher than reported.
- NJ** - This analyte has been "tentatively" identified. The numeric value represents its approximate concentration.
- Y** - This analyte coelutes with another target compound on the two chromatographic columns used for analysis.
- R** - The result for this analyte is unreliable. Additional data is needed to confirm or disprove the presence of this compound/analyte in the sample.
- RR** - Results were rejected and scheduled for resampling.

Table 3 - TCLP Test Results

TIN MILL CANAL TCLP TEST RESULTS			Transect 3						Transect 4											
			TM-SD-11	TM-SD-12	TM-SD-13	TM-SD-14	TM-SD-14	TM-SD-15	TM-SD-15	TM-SD-16	TM-SD-17	TM-SD-18	TM-SD-19	TM-SD-20	TM-SD-20					
			4/15/2015	8/12/2015	4/16/2015	4/16/2015	8/12/2015	4/16/2015	8/12/2015	4/16/2015	8/12/2015	4/16/2015	8/12/2015	4/16/2015	8/12/2015					
			Discrete	Discrete	Discrete	Discrete	Discrete	Composite	Composite	Discrete	Discrete	Discrete	Discrete	Composite	Composite					
Sample Identification		Sample Date		Sample Type		Sample Location and Depth		South 0-12"	South 3-4'	North 0-12"	North 3-4'	North 3-4'	0-12"	3-4'	South 0-12"	South 5-6'	North 0-12"	North 2-3'	0-12"	2-6'
Compound	Regulatory Level	Units																		
<b>TCLP VOC</b>																				
1,1-Dichloroethene	0.7	mg/L	0.05 U	0.05 U	0.05 U	0.05 U	0.05 U								0.05 U	0.05 U	0.05 U	0.05 U		
1,2-Dichloroethane	0.5	mg/L	0.05 U	0.05 U	0.05 U	0.05 U	0.05 U								0.05 U	0.05 U	0.05 U	0.05 U		
2-Butanone (MEK)	200.0	mg/L	5 U	5 U	5 U	5 U	5 U								5 U	5 U	5 U	5 U		
Benzene	0.5	mg/L	0.05 U	0.05 U	0.05 U	0.05 U	0.05 U								0.05 U	0.05 U	0.05 U	0.05 U		
Carbon tetrachloride	0.5	mg/L	0.05 UJ	0.05 UJ	0.05 UJ	0.05 UJ	0.05 UJ								0.05 UJ	0.05 UJ	0.05 UJ	0.05 UJ		
Chlorobenzene	100.0	mg/L	1 U	1 U	1 U	1 U	1 U								1 U	1 U	1 U	1 U		
Chloroform	6.0	mg/L	0.0036 J	0.5 U	0.0032 J	0.0047 B	0.5 U								0.0029 J	0.5 U	0.0033 J	0.5 U		
Tetrachloroethene	0.7	mg/L	0.05 U	0.05 U	0.05 U	0.05 U	0.05 U								0.05 U	0.05 U	0.05 U	0.05 U		
Trichloroethene	0.5	mg/L	0.05 U	0.05 U	0.05 U	0.05 U	0.05 U								0.05 U	0.05 U	0.05 U	0.05 U		
Vinyl chloride	0.2	mg/L	0.05 U	0.05 U	0.05 U	0.05 U	0.05 U								0.05 U	0.05 U	0.05 U	0.05 U		
<b>TCLP Metals</b>																				
Arsenic	5.0	mg/L																	0.022 J	0.05 U
Barium	100.0	mg/L																	0.24 J	0.17 B
Cadmium	1.0	mg/L																	0.0011 J	0.05 U
Chromium	5.0	mg/L																	0.0052 J	0.00096 B
Lead	5.0	mg/L																	0.0099 J	0.05 U
Selenium	1.0	mg/L																	0.0073 J	0.0071 B
Silver	5.0	mg/L																	0.05 U	0.05 U
Mercury	0.2	mg/L																	0.001 U	0.001 U
<b>TCLP SVOC</b>																				
1,4-Dichlorobenzene	7.5	mg/L																	0.5 RR	0.5 RR
2,4,5-Trichlorophenol	400.0	mg/L																	5 RR	5 RR
2,4,6-Trichlorophenol	2.0	mg/L																	0.1 RR	0.1 RR
2,4-Dinitrotoluene	0.13	mg/L																	0.1 RR	0.1 RR
2-Methylphenol(o-Cresol)	200.0	mg/L																	2 RR	2 RR
3&4-Methylphenol(m&p Cresol)	200.0	mg/L																	2 RR	2 RR
Hexachloro-1,3-butadiene	0.5	mg/L																	0.1 RR	0.1 RR
Hexachlorobenzene	0.13	mg/L																	0.1 RR	0.1 RR
Hexachloroethane	3.0	mg/L																	0.5 RR	0.5 RR
Nitrobenzene	2.0	mg/L																	0.1 RR	0.1 RR
Pentachlorophenol	100.0	mg/L																	5 RR	5 RR
Pyridine	5.0	mg/L																	0.5 RR	0.5 RR

Data Validation Qualifier Code

- J - The positive result reported for this analyte is a quantitative estimate.
- J+ - The positive result reported for this analyte is a quantitative estimate, but may be biased high.
- J- - The positive result reported for this analyte is a quantitative estimate, but may be biased low.
- B - The compound/analyte was not detected substantially above the level of the associated method blank/preparation or field blank
- U - This analyte was not detected in the sample. The numeric value represents the sample quantitation/detection limit.
- UJ - This analyte was not detected in the sample. The actual quantitation/detection limit may be higher than reported.
- NJ - This analyte has been "tentatively" identified. The numeric value represents its approximate concentration.
- Y - This analyte coelutes with another target compound on the two chromatographic columns used for analysis.
- R - The result for this analyte is unreliable. Additional data is needed to confirm or disprove the presence of this compound/analyte in the sample.
- RR - Results were rejected and scheduled for resampling.



Table 3 - TCLP Test Results

TIN MILL CANAL TCLP TEST RESULTS			Transect 5						Transect 6						
			TM-SD-21	TM-SD-22	TM-SD-22	TM-SD-23	TM-SD-24	TM-SD-25	TM-SD-25	TM-SD-27	TM-SD-28	TM-SD-29	TM-SD-30	TM-SD-31	TM-SD-31
			4/16/2015	4/16/2015	8/12/2015	4/16/2015	8/12/2015	4/16/2015	8/12/2015	4/17/2015	8/12/2015	4/20/2015	8/12/2015	4/20/2015	8/12/2015
			Discrete	Discrete	Discrete	Discrete	Discrete	Composite	Composite	Discrete	Discrete	Discrete	Discrete	Composite	Composite
Sample Identification			South 0-12"	South 4-5'	South 3-4'	North 0-12"	North 3.5-4.5'	0-12"	3-4.5'	South 0-12"	South 3-4'	North 0-12"	North 2-3'	0-12"	2-4'
Sample Date	Sample Type	Sample Location and Depth													
Compound	Regulatory Level	Units													
<b>TCLP VOC</b>															
1,1-Dichloroethene	0.7	mg/L	0.05 U	0.05 U	0.05 U	0.05 U	0.05 U			0.05 U	0.05 U	0.05 U	0.05 U		
1,2-Dichloroethane	0.5	mg/L	0.05 U	0.05 U	0.05 U	0.05 U	0.05 U			0.05 U	0.05 U	0.05 U	0.05 U		
2-Butanone (MEK)	200.0	mg/L	5 U	5 U	0.0115 J	0.0331 J	5 U			0.058 J	5 U	0.0447 J	5 U		
Benzene	0.5	mg/L	0.05 U	0.05 U	0.05 U	0.05 U	0.05 U			0.05 U	0.05 U	0.05 U	0.05 U		
Carbon tetrachloride	0.5	mg/L	0.05 UJ	0.05 U	0.05 UJ	0.05 UJ	0.05 UJ			0.05 UJ	0.05 UJ	0.05 UJ	0.05 UJ		
Chlorobenzene	100.0	mg/L	1 U	1 U	1 U	1 U	1 U			1 U	1 U	1 U	1 U		
Chloroform	6.0	mg/L	0.0028 J	0.006 B	0.5 U	0.0034 J	0.5 U			0.0024 B	0.5 U	0.5 U	0.5 U		
Tetrachloroethene	0.7	mg/L	0.05 U	0.05 U	0.05 U	0.05 U	0.05 U			0.05 U	0.05 U	0.05 U	0.05 U		
Trichloroethene	0.5	mg/L	0.05 U	0.05 U	0.05 U	0.05 U	0.05 U			0.05 U	0.05 U	0.05 U	0.05 U		
Vinyl chloride	0.2	mg/L	0.05 U	0.05 U	0.05 U	0.05 U	0.05 U			0.05 U	0.05 U	0.05 U	0.05 U		
<b>TCLP Metals</b>															
Arsenic	5.0	mg/L							0.022 J	0.0077 J				0.0077 J	0.02 B
Barium	100.0	mg/L							0.35 J	0.28 B				0.46 J	0.33 B
Cadmium	1.0	mg/L							0.00085 J	0.05 U				0.05 U	0.05 U
Chromium	5.0	mg/L							0.0068 J	0.002 B				0.0027 J	0.0052 B
Lead	5.0	mg/L							0.011 J	0.05 U				0.0057 J	0.05 U
Selenium	1.0	mg/L							0.016 J	0.1 U				0.014 J	0.013 B
Silver	5.0	mg/L							0.05 U	0.0024 B				0.0011 J	0.0025 B
Mercury	0.2	mg/L							0.001 U	0.001 U				0.001 U	0.001 U
<b>TCLP SVOC</b>															
1,4-Dichlorobenzene	7.5	mg/L							0.5 RR	0.5 RR				0.5 RR	0.5 RR
2,4,5-Trichlorophenol	400.0	mg/L							5 RR	5 RR				5 RR	5 RR
2,4,6-Trichlorophenol	2.0	mg/L							0.1 RR	0.1 RR				0.1 RR	0.1 RR
2,4-Dinitrotoluene	0.13	mg/L							0.1 RR	0.1 RR				0.1 RR	0.1 RR
2-Methylphenol(o-Cresol)	200.0	mg/L							2 RR	2 RR				2 RR	0.019 RR
3&4-Methylphenol(m&p Cresol)	200.0	mg/L							0.15 RR	0.108 RR				2 RR	0.0498 RR
Hexachloro-1,3-butadiene	0.5	mg/L							0.1 RR	0.1 RR				0.1 RR	0.1 RR
Hexachlorobenzene	0.13	mg/L							0.1 RR	0.1 RR				0.1 RR	0.1 RR
Hexachloroethane	3.0	mg/L							0.5 RR	0.5 RR				0.5 RR	0.5 RR
Nitrobenzene	2.0	mg/L							0.1 RR	0.1 RR				0.1 RR	0.1 RR
Pentachlorophenol	100.0	mg/L							5 RR	5 RR				5 RR	5 RR
Pyridine	5.0	mg/L							0.5 RR	0.5 RR				0.5 RR	0.5 RR

Data Validation Qualifier Code

- J - The positive result reported for this analyte is a quantitative estimate.
- J+ - The positive result reported for this analyte is a quantitative estimate, but may be biased high.
- J- - The positive result reported for this analyte is a quantitative estimate, but may be biased low.
- B - The compound/analyte was not detected substantially above the level of the associated method blank/preparation or field blank
- U - This analyte was not detected in the sample. The numeric value represents the sample quantitation/detection limit.
- UJ - This analyte was not detected in the sample. The actual quantitation/detection limit may be higher than reported.
- NJ - This analyte has been "tentatively" identified. The numeric value represents its approximate concentration.
- Y - This analyte coelutes with another target compound on the two chromatographic columns used for analysis.
- R - The result for this analyte is unreliable. Additional data is needed to confirm or disprove the presence of this compound/analyte in the sample.
- RR - Results were rejected and scheduled for resampling.

Table 3 - TCLP Test Results

TIN MILL CANAL TCLP TEST RESULTS			Transect 7						Transect 8							
			Sample Identification			TM-SD-32	TM-SD-33	TM-SD-34	TM-SD-35	TM-SD-36	TM-SD-36	TM-SD-37	TM-SD-38	TM-SD-39	TM-SD-40	TM-SD-41
			Sample Date			4/17/2015	8/13/2015	4/20/2015	8/13/2015	4/20/2015	8/13/2015	4/20/2015	8/13/2015	4/20/2015	8/13/2015	4/20/2015
			Sample Type			Discrete	Discrete	Discrete	Discrete	Composite	Composite	Discrete	Discrete	Discrete	Discrete	Composite
Sample Location and Depth			South 0-12"	No Recovery	North 0-12"	North 5.5-6.5'	0-12"	5.5-6.5'	South 0-12"	No Recovery	North 0-12"	No Recovery	0-12"			
Compound	Regulatory Level	Units														
<i>TCLP VOC</i>																
1,1-Dichloroethene	0.7	mg/L	0.05 U		0.05 U	0.05 U			0.05 U		0.05 U					
1,2-Dichloroethane	0.5	mg/L	0.05 U		0.05 U	0.05 U			0.05 U		0.05 U					
2-Butanone (MEK)	200.0	mg/L	5 U		5 U	0.0516 J			5 U		5 U					
Benzene	0.5	mg/L	0.05 U		0.05 U	0.05 U			0.0122 J		0.131					
Carbon tetrachloride	0.5	mg/L	0.05 U		0.05 U	0.05 U			0.05 U		0.05 U					
Chlorobenzene	100.0	mg/L	1 U		1 U	1 U			0.013 J		0.125 J					
Chloroform	6.0	mg/L	0.5 U		0.0025 B	0.5 U			0.5 U		0.5 U					
Tetrachloroethene	0.7	mg/L	0.05 U		0.05 U	0.05 U			0.05 U		0.05 U					
Trichloroethene	0.5	mg/L	0.05 U		0.05 U	0.05 U			0.05 U		0.05 U					
Vinyl chloride	0.2	mg/L	0.05 U		0.05 U	0.05 U			0.05 U		0.05 U					
<i>TCLP Metals</i>																
Arsenic	5.0	mg/L						0.0087 J	0.0049 B				0.013 J			
Barium	100.0	mg/L						0.41 J	0.59 B				0.55 J			
Cadmium	1.0	mg/L						0.05 U	0.05 U				0.05 U			
Chromium	5.0	mg/L						0.0022 J	0.002 B				0.0052 J			
Lead	5.0	mg/L						0.0073 J	0.05 U				0.0083 J			
Selenium	1.0	mg/L						0.008 J	0.0058 B				0.0098 J			
Silver	5.0	mg/L						0.0019 J	0.0045 B				0.0021 J			
Mercury	0.2	mg/L						0.001 U	0.001 U				0.001 U			
<i>TCLP SVOC</i>																
1,4-Dichlorobenzene	7.5	mg/L						0.5 RR	0.5 RR				0.5 RR			
2,4,5-Trichlorophenol	400.0	mg/L						5 RR	5 RR				5 RR			
2,4,6-Trichlorophenol	2.0	mg/L						0.1 RR	0.1 RR				0.1 RR			
2,4-Dinitrotoluene	0.13	mg/L						0.1 RR	0.1 RR				0.1 RR			
2-Methylphenol(o-Cresol)	200.0	mg/L						2 RR	2 RR				2 RR			
3&4-Methylphenol(m&p Cresol)	200.0	mg/L						2 RR	2 RR				2 RR			
Hexachloro-1,3-butadiene	0.5	mg/L						0.1 RR	0.1 RR				0.1 RR			
Hexachlorobenzene	0.13	mg/L						0.1 RR	0.1 RR				0.1 RR			
Hexachloroethane	3.0	mg/L						0.5 RR	0.5 RR				0.5 RR			
Nitrobenzene	2.0	mg/L						0.1 RR	0.1 RR				0.1 RR			
Pentachlorophenol	100.0	mg/L						5 RR	5 RR				5 RR			
Pyridine	5.0	mg/L						0.5 RR	0.5 RR				0.5 RR			

Data Validation Qualifier Code

- J** - The positive result reported for this analyte is a quantitative estimate.
- J+** - The positive result reported for this analyte is a quantitative estimate, but may be biased high.
- J-** - The positive result reported for this analyte is a quantitative estimate, but may be biased low.
- B** - The compound/analyte was not detected substantially above the level of the associated method blank/preparation or field blank
- U** - This analyte was not detected in the sample. The numeric value represents the sample quantitation/detection limit.
- UJ** - This analyte was not detected in the sample. The actual quantitation/detection limit may be higher than reported.
- NJ** - This analyte has been "tentatively" identified. The numeric value represents its approximate concentration.
- Y** - This analyte coelutes with another target compound on the two chromatographic columns used for analysis.
- R** - The result for this analyte is unreliable. Additional data is needed to confirm or disprove the presence of this compound/analyte in the sample.
- RR** - Results were rejected and scheduled for resampling.



Table 3 - TCLP Test Results

TIN MILL CANAL TCLP TEST RESULTS			Transect 9						Transect 10					
			TM-SD-42	TM-SD-43	TM-SD-44	TM-SD-45	TM-SD-46	TM-SD-46	TM-SD-47	TM-SD-48	TM-SD-49	TM-SD-50	TM-SD-51	TM-SD-51
			4/17/2015	8/13/2015	4/20/2015	8/13/2015	4/20/2015	8/13/2015	4/17/2015	8/13/2015	4/20/2015	8/13/2015	4/20/2015	8/13/2015
			Discrete	Discrete	Discrete	Discrete	Composite	Composite	Discrete	Discrete	Discrete	Discrete	Composite	Composite
Sample Identification		Sample Date	Sample Location and Depth											
Compound	Regulatory Level	Units	South 0-12"	South 6-7'	North 0-12"	No Recovery	0-12"	6-7'	South 0-12"	South 5.5-6.5'	North 0-12"	North 1.5-2.5'	0-12"	1.5-6.5'
<b>TCLP VOC</b>														
1,1-Dichloroethene	0.7	mg/L	0.05 U	0.05 U	0.05 U				0.05 U	0.05 U	0.05 U	0.05 U		
1,2-Dichloroethane	0.5	mg/L	0.05 U	0.05 U	0.05 U				0.05 U	0.05 U	0.05 U	0.05 U		
2-Butanone (MEK)	200.0	mg/L	0.0544 B	5 U	5 U				5 U	5 U	0.0304 J	5 U		
Benzene	0.5	mg/L	0.05 U	0.0089 J	0.05 U				0.05 U	0.008 J	0.05 U	0.0063 J		
Carbon tetrachloride	0.5	mg/L	0.05 U	0.05 U	0.05 U				0.05 U	0.05 U	0.05 U	0.05 U		
Chlorobenzene	100.0	mg/L	1 U	0.0078 J	1 U				1 U	0.004 J	0.0177 J	1 U		
Chloroform	6.0	mg/L	0.5 U	0.5 U	0.5 U				0.5 U	0.5 U	0.5 U	0.5 U		
Tetrachloroethene	0.7	mg/L	0.05 U	0.05 U	0.05 U				0.05 U	0.05 U	0.05 U	0.0221 J		
Trichloroethene	0.5	mg/L	0.05 U	0.05 U	0.05 U				0.05 U	0.05 U	0.05 U	0.05 U		
Vinyl chloride	0.2	mg/L	0.05 U	0.05 U	0.05 U				0.05 U	0.05 U	0.05 U	0.05 U		
<b>TCLP Metals</b>														
Arsenic	5.0	mg/L					0.019 B	0.011 J					0.016 J	0.05 U
Barium	100.0	mg/L					0.45 B	0.38 J					0.18 J	0.23 B
Cadmium	1.0	mg/L					0.05 U	0.05 U					0.05 U	0.05 U
Chromium	5.0	mg/L					0.026 B	0.0064 J					0.017 J	0.0085 B
Lead	5.0	mg/L					0.05 U	0.05 U					0.05 U	0.05 U
Selenium	1.0	mg/L					0.006 B	0.01 J					0.013 J	0.0079 B
Silver	5.0	mg/L					0.0023 B	0.0019 J					0.0021 J	0.0036 B
Mercury	0.2	mg/L					0.001 U	0.001 U					0.001 U	0.001 U
<b>TCLP SVOC</b>														
1,4-Dichlorobenzene	7.5	mg/L					0.5 RR	0.5 RR					0.5 RR	0.5 RR
2,4,5-Trichlorophenol	400.0	mg/L					5 RR	5 RR					5 RR	5 RR
2,4,6-Trichlorophenol	2.0	mg/L					0.1 RR	0.1 RR					0.1 RR	0.1 RR
2,4-Dinitrotoluene	0.13	mg/L					0.1 RR	0.1 RR					0.1 RR	0.1 RR
2-Methylphenol(o-Cresol)	200.0	mg/L					2 RR	2 RR					2 RR	2 RR
3&4-Methylphenol(m&p Cresol)	200.0	mg/L					2 RR	2 RR					2 RR	2 RR
Hexachloro-1,3-butadiene	0.5	mg/L					0.1 RR	0.1 RR					0.1 RR	0.1 RR
Hexachlorobenzene	0.13	mg/L					0.1 RR	0.1 RR					0.1 RR	0.1 RR
Hexachloroethane	3.0	mg/L					0.5 RR	0.5 RR					0.5 RR	0.5 RR
Nitrobenzene	2.0	mg/L					0.1 RR	0.1 RR					0.1 RR	0.1 RR
Pentachlorophenol	100.0	mg/L					5 RR	5 RR					5 RR	5 RR
Pyridine	5.0	mg/L					0.5 RR	0.5 RR					0.5 RR	0.5 RR

Data Validation Qualifier Code

J - The positive result reported for this analyte is a quantitative estimate.

J+ - The positive result reported for this analyte is a quantitative estimate, but may be biased high.

J- - The positive result reported for this analyte is a quantitative estimate, but may be biased low.

B - The compound/analyte was not detected substantially above the level of the associated method blank/preparation or field blank

U - This analyte was not detected in the sample. The numeric value represents the sample quantitation/detection limit.

UJ - This analyte was not detected in the sample. The actual quantitation/detection limit may be higher than reported.

NJ - This analyte has been "tentatively" identified. The numeric value represents its approximate concentration.

Y - This analyte coelutes with another target compound on the two chromatographic columns used for analysis.

R - The result for this analyte is unreliable. Additional data is needed to confirm or disprove the presence of this compound/analyte in the sample.

RR - Results were rejected and scheduled for resampling.

Table 3 - TCLP Test Results

TIN MILL CANAL TCLP TEST RESULTS			Transect 11					Transect 12						
			Sample Identification	TM-SD-53	TM-SD-54	TM-SD-55	TM-SD-56	TM-SD-57	TM-SD-58	TM-SD-59	TM-SD-60	TM-SD-61	TM-SD-62	TM-SD-62
			Sample Date	4/17/2015	8/13/2015	4/20/2015	8/13/2015	4/20/2015	4/17/2015	8/13/2015	4/20/2015	8/13/2015	4/20/2015	8/13/2015
			Sample Type	Discrete	Discrete	Discrete	Discrete	Composite	Discrete	Discrete	Discrete	Discrete	Composite	Composite
Sample Location and Depth			South 0-12"	Inaccessible	North 0-12"	Inaccessible	0-12"	South 0-12"	Inaccessible	North 0-12"	North 3.5-4.5'	0-12"	3.5-4.5'	
Compound	Regulatory Level	Units												
<b>TCLP VOC</b>														
1,1-Dichloroethene	0.7	mg/L	0.05 U		0.05 U			0.05 U		0.05 U	0.05 U			
1,2-Dichloroethane	0.5	mg/L	0.05 U		0.05 U			0.05 U		0.05 U	0.05 U			
2-Butanone (MEK)	200.0	mg/L	0.0414 J		5 U			0.0584 B		5 U	5 U			
Benzene	0.5	mg/L	0.05 U		0.05 U			0.05 U		0.05 U	0.0082 J			
Carbon tetrachloride	0.5	mg/L	0.05 U		0.05 U			0.05 U		0.05 U	0.05 U			
Chlorobenzene	100.0	mg/L	1 U		1 U			1 U		0.0053 J	0.0249 J			
Chloroform	6.0	mg/L	0.5 U		0.5 U			0.5 U		0.0022 B	0.5 U			
Tetrachloroethene	0.7	mg/L	0.05 U		0.05 U			0.05 U		0.05 U	0.05 U			
Trichloroethene	0.5	mg/L	0.05 U		0.05 U			0.05 U		0.05 U	0.05 U			
Vinyl chloride	0.2	mg/L	0.05 U		0.05 U			0.05 U		0.05 U	0.05 U			
<b>TCLP Metals</b>														
Arsenic	5.0	mg/L					0.016 J					0.05 U	0.0059 B	
Barium	100.0	mg/L					0.15 J					0.51 J	0.28 B	
Cadmium	1.0	mg/L					0.0006 J					0.05 U	0.05 U	
Chromium	5.0	mg/L					0.03 J					0.0073 J	0.012 B	
Lead	5.0	mg/L					0.0084 J					0.0068 J	0.05 U	
Selenium	1.0	mg/L					0.0098 J					0.0054 J	0.008 B	
Silver	5.0	mg/L					0.0016 J					0.05 U	0.0043 B	
Mercury	0.2	mg/L					0.001 U					0.001 U	0.001 U	
<b>TCLP SVOC</b>														
1,4-Dichlorobenzene	7.5	mg/L					0.5 RR					0.5 RR	0.5 RR	
2,4,5-Trichlorophenol	400.0	mg/L					5 RR					5 RR	5 RR	
2,4,6-Trichlorophenol	2.0	mg/L					0.1 RR					0.1 RR	0.1 RR	
2,4-Dinitrotoluene	0.13	mg/L					0.1 RR					0.1 RR	0.1 RR	
2-Methylphenol(o-Cresol)	200.0	mg/L					2 RR					2 RR	2 RR	
3&4-Methylphenol(m&p Cresol)	200.0	mg/L					2 RR					2 RR	2 RR	
Hexachloro-1,3-butadiene	0.5	mg/L					0.1 RR					0.1 RR	0.1 RR	
Hexachlorobenzene	0.13	mg/L					0.1 RR					0.1 RR	0.1 RR	
Hexachloroethane	3.0	mg/L					0.5 RR					0.5 RR	0.5 RR	
Nitrobenzene	2.0	mg/L					0.1 RR					0.1 RR	0.1 RR	
Pentachlorophenol	100.0	mg/L					5 RR					5 RR	5 RR	
Pyridine	5.0	mg/L					0.5 RR					0.5 RR	0.5 RR	

Data Validation Qualifier Code

- J** - The positive result reported for this analyte is a quantitative estimate.
- J+** - The positive result reported for this analyte is a quantitative estimate, but may be biased high.
- J-** - The positive result reported for this analyte is a quantitative estimate, but may be biased low.
- B** - The compound/analyte was not detected substantially above the level of the associated method blank/preparation or field blank
- U** - This analyte was not detected in the sample. The numeric value represents the sample quantitation/detection limit.
- UJ** - This analyte was not detected in the sample. The actual quantitation/detection limit may be higher than reported.
- NJ** - This analyte has been "tentatively" identified. The numeric value represents its approximate concentration.
- Y** - This analyte coelutes with another target compound on the two chromatographic columns used for analysis.
- R** - The result for this analyte is unreliable. Additional data is needed to confirm or disprove the presence of this compound/analyte in the sample.
- RR** - Results were rejected and scheduled for resampling.



Table 3 - TCLP Test Results

TIN MILL CANAL TCLP TEST RESULTS			Transect 13						Transect 14					
			TM-SD-63	TM-SD-64	TM-SD-65	TM-SD-66	TM-SD-67	TM-SD-67	TM-SD-68	TM-SD-69	TM-SD-70	TM-SD-71	TM-SD-72	TM-SD-72
			4/17/2015	8/13/2015	4/20/2015	8/13/2015	4/20/2015	8/13/2015	4/17/2015	8/13/2015	4/17/2015	8/13/2015	4/17/2015	8/13/2015
			Discrete	Discrete	Discrete	Discrete	Composite	Composite	Discrete	Discrete	Discrete	Discrete	Composite	Composite
Sample Identification		Sample Date	Sample Location and Depth											
Compound	Regulatory Level	Units	South 0-12"	South 5-6'	North 0-12"	North 6-7'	0-12"	5-7'	South 0-12"	South 5-6'	North 0-12"	Inaccessible	0-12"	5-6'
<b>TCLP VOC</b>														
1,1-Dichloroethene	0.7	mg/L	0.05 U	0.05 UJ	0.05 U	0.05 U			0.05 U	0.05 U	0.05 U			
1,2-Dichloroethane	0.5	mg/L	0.05 U	0.05 UJ	0.05 U	0.05 U			0.05 U	0.05 U	0.05 U			
2-Butanone (MEK)	200.0	mg/L	0.0421 B	5 UJ	5 U	5 U			5 U	5 U	5 U			
Benzene	0.5	mg/L	0.05 U	0.05 UJ	0.05 U	0.05 U			0.05 U	0.05 U	0.0795			
Carbon tetrachloride	0.5	mg/L	0.05 U	0.05 UJ	0.05 U	0.05 U			0.05 U	0.05 U	0.05 U			
Chlorobenzene	100.0	mg/L	1 U	0.0098 J	1 U	0.0077 J			1 U	1 U	1 U			
Chloroform	6.0	mg/L	0.5 U	0.5 UJ	0.5 U	0.5 U			0.5 U	0.5 U	0.5 U			
Tetrachloroethene	0.7	mg/L	0.05 U	0.05 UJ	0.05 U	0.05 U			0.05 U	0.05 U	0.05 U			
Trichloroethene	0.5	mg/L	0.05 U	0.05 UJ	0.05 U	0.05 U			0.05 U	0.05 U	0.05 U			
Vinyl chloride	0.2	mg/L	0.05 U	0.05 UJ	0.05 U	0.05 U			0.05 U	0.05 U	0.05 U			
<b>TCLP Metals</b>														
Arsenic	5.0	mg/L						0.0097 J	0.0058 B				0.05 U	0.012 B
Barium	100.0	mg/L						0.1 J	0.36 B				0.31 J	0.21 B
Cadmium	1.0	mg/L						0.00099 J	0.05 U				0.00061 J	0.05 U
Chromium	5.0	mg/L						0.00097 J	0.019 B				0.0043 J	0.044 B
Lead	5.0	mg/L						0.05 U	0.05 U				0.0039 J	0.05 U
Selenium	1.0	mg/L						0.014 J	0.0047 B				0.0084 J	0.0069 B
Silver	5.0	mg/L						0.0033 J	0.004 B				0.0022 J	0.002 B
Mercury	0.2	mg/L						0.001 U	0.001 U				0.001 U	0.001 U
<b>TCLP SVOC</b>														
1,4-Dichlorobenzene	7.5	mg/L						0.5 RR	0.5 RR				0.5 RR	0.5 RR
2,4,5-Trichlorophenol	400.0	mg/L						5 RR	5 RR				5 RR	5 RR
2,4,6-Trichlorophenol	2.0	mg/L						0.1 RR	0.1 RR				0.1 RR	0.1 RR
2,4-Dinitrotoluene	0.13	mg/L						0.1 RR	0.1 RR				0.1 RR	0.1 RR
2-Methylphenol(o-Cresol)	200.0	mg/L						2 RR	2 RR				2 RR	2 RR
3&4-Methylphenol(m&p Cresol)	200.0	mg/L						2 RR	2 RR				2 RR	2 RR
Hexachloro-1,3-butadiene	0.5	mg/L						0.1 RR	0.1 RR				0.1 RR	0.1 RR
Hexachlorobenzene	0.13	mg/L						0.1 RR	0.1 RR				0.1 RR	0.1 RR
Hexachloroethane	3.0	mg/L						0.5 RR	0.5 RR				0.5 RR	0.5 RR
Nitrobenzene	2.0	mg/L						0.1 RR	0.1 RR				0.1 RR	0.1 RR
Pentachlorophenol	100.0	mg/L						5 RR	5 RR				5 RR	5 RR
Pyridine	5.0	mg/L						0.5 RR	0.5 RR				0.5 RR	0.5 RR

Data Validation Qualifier Code

- J - The positive result reported for this analyte is a quantitative estimate.
- J+ - The positive result reported for this analyte is a quantitative estimate, but may be biased high.
- J- - The positive result reported for this analyte is a quantitative estimate, but may be biased low.
- B - The compound/analyte was not detected substantially above the level of the associated method blank/preparation or field blank
- U - This analyte was not detected in the sample. The numeric value represents the sample quantitation/detection limit.
- UJ - This analyte was not detected in the sample. The actual quantitation/detection limit may be higher than reported.
- NJ - This analyte has been "tentatively" identified. The numeric value represents its approximate concentration.
- Y - This analyte coelutes with another target compound on the two chromatographic columns used for analysis.
- R - The result for this analyte is unreliable. Additional data is needed to confirm or disprove the presence of this compound/analyte in the sample.
- RR - Results were rejected and scheduled for resampling.

Table 3 - TCLP Test Results

TIN MILL CANAL TCLP TEST RESULTS			Transect 15						Transect 16						Transect 17		
			TM-SD-73	TM-SD-74	TM-SD-75	TM-SD-76	TM-SD-77	TM-SD-79	TM-SD-80	TM-SD-81	TM-SD-82	TM-SD-83	TM-SD-84	TM-SD-86	TM-SD-88		
			4/17/2015	8/14/2015	4/17/2015	8/14/2015	4/17/2015	8/14/2015	4/17/2015	8/14/2015	4/17/2015	8/14/2015	4/17/2015	8/14/2015	4/20/2015	4/20/2015	
			Discrete	Discrete	Discrete	Discrete	Composite	Composite	Discrete	Discrete	Discrete	Discrete	Composite	Composite	Discrete	Discrete	Composite
Sample Identification			Sample Date		Sample Type		Sample Location and Depth		Sample Location and Depth		Sample Location and Depth		Sample Location and Depth				
Compound	Regulatory Level	Units	South 0-12"	South 5-6'	North 0-12"	North 3-4'	0-12"	3-6'	South 0-12"	South 5.5-6.5'	North 0-12"	North 5-6'	0-12"	5-6.5'	0-12"	5-6'	5-6'
<b>TCLP VOC</b>																	
1,1-Dichloroethene	0.7	mg/L	0.05 U	0.05 U	0.05 U	0.05 U			0.05 U	0.05 U	0.05 U	0.05 U			0.05 U	0.05 U	
1,2-Dichloroethane	0.5	mg/L	0.05 U	0.05 U	0.05 U	0.05 U			0.05 U	0.05 U	0.05 U	0.05 U			0.05 U	0.05 U	
2-Butanone (MEK)	200.0	mg/L	0.0343 B	0.0331 J	5 U	5 U			5 U	5 U	0.0398 J	5 U			0.0299 J	0.0329 J	
Benzene	0.5	mg/L	0.05 U	0.05 U	0.05 U	0.05 U			0.05 U	0.05 U	0.05 U	0.05 U			0.05 U	0.05 U	
Carbon tetrachloride	0.5	mg/L	0.05 U	0.05 U	0.05 U	0.05 U			0.05 U	0.05 U	0.05 U	0.05 U			0.05 U	0.05 U	
Chlorobenzene	100.0	mg/L	1 U	1 U	1 U	1 U			1 U	1 U	1 U	1 U			1 U	1 U	
Chloroform	6.0	mg/L	0.5 U	0.5 U	0.5 U	0.5 U			0.5 U	0.5 U	0.5 U	0.5 U			0.0024 B	0.5 U	
Tetrachloroethene	0.7	mg/L	0.05 U	0.05 U	0.05 U	0.05 U			0.05 U	0.05 U	0.05 U	0.05 U			0.05 U	0.05 U	
Trichloroethene	0.5	mg/L	0.05 U	0.05 U	0.05 U	0.05 U			0.05 U	0.05 U	0.05 U	0.05 U			0.05 U	0.05 U	
Vinyl chloride	0.2	mg/L	0.05 U	0.05 U	0.05 U	0.05 U			0.05 U	0.05 U	0.05 U	0.05 U			0.05 U	0.05 U	
<b>TCLP Metals</b>																	
Arsenic	5.0	mg/L						0.05 U	0.015 B					0.05 U	0.0091 B		0.012 J
Barium	100.0	mg/L						0.59 J	1.1					0.4 J	0.52 B		1.2
Cadmium	1.0	mg/L						0.05 U	0.05 U					0.05 U	0.05 U		0.00056 J
Chromium	5.0	mg/L						0.004 J	0.015 B					0.0053 J	0.0026 B		0.0019 J
Lead	5.0	mg/L						0.0041 J	0.026 B					0.0062 J	0.0039 B		0.016 J
Selenium	1.0	mg/L						0.021 J	0.012 B					0.0083 J	0.014 B		0.017 J
Silver	5.0	mg/L						0.0018 J	0.0014 B					0.0017 J	0.0039 B		0.001 J
Mercury	0.2	mg/L						0.001 U	0.001 U					0.001 U	0.001 U		0.001 U
<b>TCLP SVOC</b>																	
1,4-Dichlorobenzene	7.5	mg/L						0.5 RR	0.5 RR					0.5 RR	0.5 RR		0.5 RR
2,4,5-Trichlorophenol	400.0	mg/L						5 RR	5 RR					5 RR	5 RR		5 RR
2,4,6-Trichlorophenol	2.0	mg/L						0.1 RR	0.1 RR					0.1 RR	0.1 RR		0.1 RR
2,4-Dinitrotoluene	0.13	mg/L						0.1 RR	0.1 RR					0.1 RR	0.1 RR		0.1 RR
2-Methylphenol(o-Cresol)	200.0	mg/L						2 RR	2 RR					2 RR	2 RR		2 RR
3&4-Methylphenol(m&p Cresol)	200.0	mg/L						2 RR	2 RR					2 RR	0.0438 RR		2 RR
Hexachloro-1,3-butadiene	0.5	mg/L						0.1 RR	0.1 RR					0.1 RR	0.1 RR		0.1 RR
Hexachlorobenzene	0.13	mg/L						0.1 RR	0.1 RR					0.1 RR	0.1 RR		0.1 RR
Hexachloroethane	3.0	mg/L						0.5 RR	0.5 RR					0.5 RR	0.5 RR		0.5 RR
Nitrobenzene	2.0	mg/L						0.1 RR	0.1 RR					0.1 RR	0.1 RR		0.1 RR
Pentachlorophenol	100.0	mg/L						5 RR	5 RR					5 RR	5 RR		5 RR
Pyridine	5.0	mg/L						0.5 RR	0.5 RR					0.5 RR	0.5 RR		0.5 RR

Data Validation Qualifier Code

- J** - The positive result reported for this analyte is a quantitative estimate.
- J+** - The positive result reported for this analyte is a quantitative estimate, but may be biased high.
- J-** - The positive result reported for this analyte is a quantitative estimate, but may be biased low.
- B** - The compound/analyte was not detected substantially above the level of the associated method blank/preparation or field blank
- U** - This analyte was not detected in the sample. The numeric value represents the sample quantitation/detection limit.
- UJ** - This analyte was not detected in the sample. The actual quantitation/detection limit may be higher than reported.
- NI** - This analyte has been "tentatively" identified. The numeric value represents its approximate concentration.
- Y** - This analyte coelutes with another target compound on the two chromatographic columns used for analysis.
- R** - The result for this analyte is unreliable. Additional data is needed to confirm or disprove the presence of this compound/analyte in the sample.
- RR** - Results were rejected and scheduled for resampling.