

RESPONSE AND DEVELOPMENT WORK PLAN

AREA B: SUB-PARCEL B6-3
TRADEPOINT ATLANTIC
SPARROWS POINT, MARYLAND

Prepared For:



ENVIROANALYTICS GROUP, LLC

1515 Des Peres Road, Suite 300
Saint Louis, Missouri 63131

Prepared By:



ARM GROUP LLC

9175 Guilford Road
Suite 310
Columbia, Maryland 21046

ARM Project No. 20010206

Respectfully Submitted,

A handwritten signature in black ink that reads "Joshua M. Barna".

Joshua M. Barna, G.I.T.
Staff Geologist

A handwritten signature in black ink that reads "Neil Peters".

T. Neil Peters, P.E.
Senior Vice President

Revision 1 – June 17, 2020

TABLE OF CONTENTS

1.0	Introduction.....	1
2.0	Site Description and History.....	4
2.1	Site Description.....	4
2.2	Site History.....	4
3.0	Environmental Site Assessment Results.....	5
3.1	Phase I Environmental Site Assessment Results.....	5
3.2	Investigation Results – Sub-Parcel B6-3.....	6
3.2.1	Phase II Soil Investigation Findings.....	6
3.2.2	Phase II Groundwater Investigation Findings.....	7
3.2.3	Locations of Potential Concern.....	8
3.3	Human Health Screening Level Risk Assessment.....	9
3.3.1	Analysis Process.....	9
3.3.2	Sub-Parcel B6-3 SLRA Results and Risk Characterization.....	12
3.3.3	Evaluation of Comprehensive Environmental Response, Compensation, and Liability Act Criteria.....	15
4.0	Proposed Site Development Plan.....	18
4.1	Response Phase – Groundwater Network Abandonment.....	19
4.2	Development Phase.....	19
4.2.1	Erosion and Sediment Control Installation.....	19
4.2.2	Grading and Site Preparation.....	20
4.2.3	Installation of Structures and Underground Utilities.....	20
4.2.4	Floor Slabs and Paving.....	20
4.2.5	Landscaping.....	21
4.2.6	Stormwater Management.....	21
5.0	Development Implementation Protocols.....	22
5.1	Development Phase.....	22
5.1.1	Erosion/Sediment Control.....	23
5.1.2	Soil Excavation and Utility Trenching.....	23
5.1.3	Soil Sampling and Disposal.....	24
5.1.4	Fill.....	25
5.1.5	Dust Control.....	25
5.2	Water Management.....	27
5.2.1	Groundwater PAL Exceedances.....	27
5.2.2	Dewatering.....	27
5.3	Health and Safety.....	28
5.4	Institutional Controls (Future Land Use Controls).....	29
5.5	Post Remediation Requirements.....	30
5.6	Construction Oversight.....	30
6.0	Permits, Notifications and Contingencies.....	32
7.0	Implementation Schedule.....	33

TABLE OF CONTENTS (CONT.)

FIGURES

Figure 1	Area A & Area B Parcels.....	Following Text
Figure 2	Proposed Grading Plan	Following Text
Figure 3	Proposed Utility Plan	Following Text
Figure 4	Phase II Soil Sample Locations	Following Text
Figure SB1	Soil SVOC PAL Exceedances	Following Text
Figure SB2	Soil Inorganic PAL Exceedances.....	Following Text
Figure 5	Phase II Groundwater Sample Locations.....	Following Text
Figure GW1	Groundwater PAL Exceedances	Following Text
Figure 6	Groundwater Network Abandonment.....	Following Text
Figure 7	Shallow Groundwater Contour Map (with Grading Plan).....	Following Text

TABLES

Table 1	Summary of Organics Detected in Soil	Following Text
Table 2	Summary of Inorganics Detected in Soil	Following Text
Table 3	Summary of Organics Detected in Groundwater.....	Following Text
Table 4	Summary of Inorganics Detected in Groundwater	Following Text
Table 5	COPC Screening Analysis	Following Text
Table 6	Assessment of Lead	Following Text
Table 7	Soil Exposure Point Concentrations	Following Text
Table 8	Risk Ratios – Composite Worker Surface Soil.....	Following Text
Table 9	Risk Ratios – Composite Worker Sub-Surface Soil	Following Text
Table 10	Risk Ratios – Composite Worker Pooled Soil.....	Following Text
Table 11	Risk Ratios – Construction Worker Surface Soil	Following Text
Table 12	Risk Ratios – Construction Worker Sub-Surface Soil.....	Following Text
Table 13	Risk Ratios – Construction Worker Pooled Soil.....	Following Text

TABLE OF CONTENTS (CONT.)

APPENDICES

Appendix A	CHS Request Letter from Tradepoint Atlantic	Following Text
Appendix B	Construction Worker SSLs – Calculation Spreadsheet	Following Text
Appendix C	Personal Protective Equipment Standard Operational Procedure.....	Following Text
Appendix D	Development Plan Drawings	Following Text
Appendix E	Minimum Capping Section Details.....	Following Text
Appendix F	Utility Trench Section Detail	Following Text
Appendix G	Utility Excavation NAPL Contingency Plan	Following Text
Appendix H	Health and Safety Plan.....	Following Text

ELECTRONIC ATTACHMENTS

Soil Laboratory Certificates of Analysis.....	Electronic Attachment
Soil Data Validation Reports	Electronic Attachment
Groundwater Laboratory Certificates of Analysis	Electronic Attachment
Groundwater Data Validation Reports.....	Electronic Attachment
ProUCL Input Tables (formatted soil analytical data).....	Electronic Attachment
ProUCL Output Tables	Electronic Attachment
Lead Evaluation Spreadsheet.....	Electronic Attachment

1.0 INTRODUCTION

ARM Group LLC (ARM), on behalf of EnviroAnalytics Group, LLC (EAG), has prepared this Response and Development Work Plan (RADWP) for a portion of the Tradepoint Atlantic property that has been designated as Area B: Sub-Parcel B6-3 (the Site). Tradepoint Atlantic submitted a letter (**Appendix A**) requesting an expedited plan review to achieve construction deadlines for the proposed development on this Site. Parcel B6 is comprised of approximately 148.5 acres of the approximately 3,100-acre former plant property. As shown on **Figure 1**, Sub-Parcel B6-3 consists of approximately 30.3 acres located within Parcel B6.

As shown on **Figure 2** and **Figure 3**, Sub-Parcel B6-3 is slated for development and occupancy as a logistics center (Logistics Center VI). The logistics center will include main office and warehouse space, with a total area of approximately 400,000 square feet (including 32,000 square feet of office space). Associated water lines, sanitary sewer lines, storm drains, conventional and trailer parking, access roads, and interior roads are also proposed. The planned development activities will generally include grading; construction of the main 400,000 square foot building; installation of utilities; landscaping and paving of parking areas and roadways. Subsequent site-use will involve workers in the on-site building, and truck drivers entering and leaving the Site with goods. Outside of the main development area designated as Sub-Parcel B6-3, temporary construction zones (not intended for permanent occupancy) with a total area of approximately 0.7 acres within the Limit of Disturbance (LOD) will be utilized to install the facility entrance and subgrade utility connections for the project.

A Logistics Center Grading Plan (Revision 0 dated March 3, 2020) was previously submitted to allow Tradepoint Atlantic to proceed with grading (site preparation) for the future construction of the warehouse building designated as Logistics Center VI. The proposed grading work was limited to the footprint of the proposed warehouse building and the immediately surrounding area. The preceding plan did not include the full scope of grading work required to facilitate development of Sub-Parcel B6-3 as described herein. The Logistics Center Grading Plan was approved for implementation on March 13, 2020, and the scope of work proposed in that plan is ongoing.

The conduct of any environmental assessment and cleanup activities on the Tradepoint Atlantic property, as well as any associated development, is subject to the requirements outlined in the following agreements:

- Administrative Consent Order (ACO) between Tradepoint Atlantic (formerly Sparrows Point Terminal, LLC) and the Maryland Department of the Environment (MDE), effective September 12, 2014; and
- Settlement Agreement and Covenant Not to Sue (SA) between Tradepoint Atlantic (formerly Sparrows Point Terminal, LLC) and the United States Environmental Protection Agency (USEPA), effective November 25, 2014.

Sub-Parcel B6-3 is part of the acreage that was removed (Carveout Area) from inclusion in the Multimedia Consent Decree between Bethlehem Steel Corporation, the USEPA, and the MDE (effective October 8, 1997) as documented in correspondence received from USEPA on September 12, 2014. Based on this agreement, USEPA determined that no further investigation or corrective measures will be required under the terms of the Consent Decree for the Carveout Area. However, the SA reflects that the property within the Carveout Area will remain subject to the USEPA's Resource Conservation and Recovery Act (RCRA) Corrective Action authorities.

An application to enter the full Tradepoint Atlantic property (3,100 acres) into the MDE Voluntary Cleanup Program (MDE-VCP) was submitted to the MDE and delivered on June 27, 2014. The property's current and anticipated future use is Tier 3 (Industrial), and plans for the property include demolition and redevelopment over several years.

In consultation with the MDE, Tradepoint Atlantic affirms that it desires to accelerate the assessment, remediation, and redevelopment of certain sub-parcels within the larger site due to current market conditions. To that end, the MDE and Tradepoint Atlantic agree that the Controlled Hazardous Substance (CHS) Act (Section 7-222 of the Environment Article) and the CHS Response Plan (Code of Maryland Regulations (COMAR) 26.14.02) shall serve as the governing statutory and regulatory authority for completing the development activities on Sub-Parcel B6-3 and complement the statutory requirements of the VCP (Section 7-501 of the Environment Article). Upon submission of a RADWP and completion of any remedial activities for the sub-parcel, the MDE shall issue a No Further Action Letter (NFA) upon a recordation of an Environmental Covenant describing any necessary land use controls for the specific sub-parcel. At such time that all the sub-parcels within the larger parcel have completed remedial activities, Tradepoint Atlantic shall submit to the MDE a request for issuing a Certificate of Completion (COC) as well as all pertinent information concerning completion of remedial activities conducted on the parcel. Once the VCP has completed its review of the submitted information it shall issue a COC for the entire parcel described in Tradepoint Atlantic's VCP application.

Alternatively, Tradepoint Atlantic or other entity may elect to submit an application for a specific sub-parcel and submit it to the VCP for review and acceptance. If the application is received after the cleanup and redevelopment activities described in this RADWP are implemented and a NFA is issued by the MDE pursuant to the CHS Act, the VCP shall prepare a No Further Requirements Determination for the sub-parcel.

If Tradepoint Atlantic or other entity has not carried out cleanup and redevelopment activities described in the RADWP, the cleanup and redevelopment activities may be conducted under the oversight authority of either the VCP or the CHS Act, so long as those activities comport with this RADWP.

This RADWP provides a Site description and history; summary of environmental conditions identified by the Phase I Environmental Site Assessment (ESA); summary of relevant findings and environmental conditions identified by the Parcel B6 Phase II Investigation and Finishing Mills Groundwater Phase II Investigation; a human health Screening Level Risk Assessment (SLRA) conducted for the identified conditions; and any necessary engineering and/or institutional controls to facilitate the planned Sub-Parcel B6-3 development and address the impacts and potential human health exposures. These controls include work practices and applicable protocols that are submitted for approval to support the development and use of the Site. Engineering/institutional controls approved and installed for this RADWP shall be described in closure certification documentation submitted to the MDE demonstrating that exposure pathways on the Site are addressed in a manner that protects public health and the environment.

Parcel B6 contains two other development areas covered by previously implemented RADWPs. Sub-Parcel B6-1 consists of 73 acres, with the majority located within Parcel B6, but also extending into Parcel B22 and Parcel B3. The details of this development project can be found in the RADWP for Sub-Parcel B6-1 (Revision 2 dated July 7, 2017). Sub-Parcel B6-2 consists of 50.5 acres of the northern portion of Parcel B6. The details of this development project can be found in the RADWP for Sub-Parcel B6-2 (Revision 1 dated January 24, 2018) and associated addendum for Retail Area #1 (Revision 2 dated May 22, 2018). The referenced RADWPs, in addition to this document, address most of the acreage with Parcel B6.

The remaining acreage of Parcel B6 will be addressed in future work associated with completion of the obligations of the ACO and associated VCP requirements. This work will include assessments of risk and, if necessary, RADWPs to address unacceptable risks associated with the proposed future land use. As noted above, temporary construction zones with a total area of approximately 0.7 acres will be utilized to install the facility entrance and subgrade utility connections for the project outside of the sub-parcel. The temporary work outside of the boundary of the Site is not intended to be the basis for the issuance of a NFA or a COC, although the scope of construction is covered by this RADWP.

2.0 SITE DESCRIPTION AND HISTORY

2.1 SITE DESCRIPTION

Parcel B6 includes an area of approximately 148.5 acres as shown on **Figure 1**. The Sub-Parcel B6-3 development project consists of approximately 30.3 acres intended for occupancy comprising the eastern section of Parcel B6. The development will include construction of a logistics center totaling approximately 400,000 square feet (**Figure 2** and **Figure 3**). Outside of the main development area designated as Sub-Parcel B6-3, temporary construction zones (not intended for permanent occupancy) with a total area of approximately 0.7 acres within the construction LOD will be utilized to install the facility entrance and subgrade utility connections for the project. The Site is currently zoned Manufacturing Heavy-Industrial Major (MH-IM), and is not occupied. There is no groundwater use on-site or within the surrounding Tradepoint Atlantic property.

Sub-Parcel B6-3 is at an elevation of approximately 9 to 15 feet above mean sea level (amsl) in most areas. The eastern half of the Site (which is vacant but includes a significant portion of the historical Contractor's Village) is generally at higher elevations than the western half (which includes a number of existing railways). According to Figure B-2 of the Stormwater Pollution Prevention Plan (SWPPP) Revision 8 dated April 2, 2020, stormwater from Sub-Parcel B6-3 is directed towards the Tin Mill Canal (TMC) to the north and west and is ultimately discharged through the National Pollution Discharge Elimination System (NPDES) Outfall 014 to Bear Creek located distantly to the west.

2.2 SITE HISTORY

From the late 1800s until 2012, the production and manufacturing of steel was conducted at Sparrows Point. Iron and steel production operations and processes at Sparrows Point included raw material handling, coke production, sinter production, iron production, steel production, and semi-finished and finished product preparation. In 1970, Sparrows Point was the largest steel facility in the United States, producing hot and cold rolled sheets, coated materials, pipes, plates, and rod and wire. The steel making operations at the facility ceased in fall 2012.

The proposed Sub-Parcel B6-3 development project includes the eastern portion of Parcel B6. Several iron and steel work processes were completed within the boundary of Parcel B6, which was occupied in part by the Hot Strip Mill. The Hot Strip Mill was located outside (to the west) of Sub-Parcel B6-3. The western half of Sub-Parcel B6-3 was historically occupied by a number of railways oriented in a north-south direction which presumably serviced the former Hot Strip Mill. The eastern half of Sub-Parcel B6-3 included the majority of the former Contractor's Village, which was used by numerous contractors for equipment and material staging for use at the steel plant. More information regarding the specific historical activities conducted at the Site can be found in the Phase II Investigation Work Plan for Parcel B6 (Revision 2 dated May 12, 2016).

3.0 ENVIRONMENTAL SITE ASSESSMENT RESULTS

3.1 PHASE I ENVIRONMENTAL SITE ASSESSMENT RESULTS

A Phase I ESA was completed by Weaver Boos Consultants for the entire Sparrows Point property on May 19, 2014. Weaver Boos completed site visits of Sparrows Point from February 19 through 21, 2014, for the purpose of characterizing current conditions at the former steel plant. The Phase I ESA identified particular features across the Tradepoint Atlantic property which presented potential risks to the environment. These Recognized Environmental Conditions (RECs) included buildings and process areas where releases of hazardous substances and/or petroleum products potentially may have occurred. The Phase I ESA also relied upon findings identified during a previous visual site inspection (VSI) conducted as part of the RCRA Facility Assessment (RFA) prepared by A.T. Kearney, Inc. dated August 1993, for the purpose of identifying Solid Waste Management Units (SWMUs) and Areas of Concern (AOCs) on the property. This 1991 VSI is regularly cited in the Description of Current Conditions (DCC) Report prepared by Rust Environment and Infrastructure, dated January 1998 (included with Weaver Boos' Phase I ESA).

Weaver Boos' distinction of a REC or Non-REC was based upon the findings of the DCC Report (which was prepared when the features remained on-site in 1998) or on observations of the general area during their site visit. Weaver Boos made the determination to identify a feature as a REC based on historical information, observations during the site visit, and prior knowledge and experience. The following RECs were identified within, or near, Sub-Parcel B6-3:

Former Fuel UST at Contractor's Village (REC 20, Finding 270):

During Weaver Boos' site visit, an area of storage buildings included in the former Contractor's Village was observed east of the railyard. The area was formerly used by contractors for equipment and material staging for use in the mill. A diesel fuel UST was formerly located along the eastern edge of the Contractor's Village. The UST was removed, and according to the Phase I ESA it is unclear whether any leaks or staining were observed in the surrounding soil.

Hot Strip Mill Cooling Tower (undesignated REC, Finding 30, also listed as SWMU 65):

Wastewater from the Hot Strip Mill basins was discharged to the cooling tower. If the cooling tower was unable to accept the wastewater volume, the TMC acted as the overflow. Heavy oil and grease impacted scale was observed on the tower and surrounding ground during Weaver Boos' site visit. Materials in the impacted scale were likely to contain hazardous substances and/or petroleum products which may have resulted in a release to the environment.

Relevant SWMUs and AOCs were also identified as located on Figure 3-1 from the DCC Report. This figure generally shows the SWMUs, AOCs, and main facility areas within the property boundaries. SWMU 65 (Hot Strip Mill Cooling Tower) is cross-listed as a REC and discussed above. There were no AOCs or additional SWMUs identified within the Site boundary.

3.2 INVESTIGATION RESULTS – SUB-PARCEL B6-3

Phase II Investigations specific to soil and groundwater conditions were performed for the property area including Sub-Parcel B6-3 in accordance with the requirements outlined in the ACO as further described in the following agency-approved Phase II Investigation Work Plans:

- Area B: Parcel B6 (Revision 2) dated May 12, 2016
- Finishing Mills Groundwater Investigation (Revision 1) dated July 7, 2016

All soil samples (Parcel B6 Phase II Investigation) and groundwater samples (Finishing Mills Groundwater Phase II Investigation) were collected and analyzed in accordance with agency-approved protocols during the Phase II Investigations, the specific details of which can be reviewed in each agency-approved Work Plan. Each Phase II Investigation was developed to target specific features which represented a potential release of hazardous substances and/or petroleum products to the environment, including RECs, SWMUs, and AOCs, as applicable, as well as numerous other targets identified from former operations that would have the potential for environmental contamination. Samples were also collected at site-wide locations to ensure full coverage of each investigation area. The full analytical results and conclusions of each investigation have been presented to the agencies in the following Phase II Investigation Reports:

- Area B: Parcel B6 (Revision 2) dated March 16, 2018
- Finishing Mills Groundwater Investigation (Revision 0) dated November 30, 2016

This RADWP summarizes the relevant soil and groundwater findings from these Phase II Investigations with respect to the proposed development of Sub-Parcel B6-3.

3.2.1 Phase II Soil Investigation Findings

Based on the scope of development, 40 soil samples collected from 19 soil borings during the Parcel B6 Phase II Investigation were included in this evaluation of Sub-Parcel B6-3. The 19 boring locations are shown on **Figure 4**, and the samples obtained from these borings provided relevant analytical data for discussion of on-site conditions. Note that two of the selected soil borings, B6-081-SB and B6-082-SB, are located outside Sub-Parcel B6-3; however, data from these locations have been included in this evaluation because they are close to the development LOD and characterize soil in the temporary construction zones that are to be used for construction of utilities at the northern end of the sub-parcel.

Soil samples collected during the Phase II Investigation were analyzed for the USEPA Target Compound List (TCL) semi-volatile organic compounds (SVOCs), TCL volatile organic compounds (VOCs), total petroleum hydrocarbon (TPH) diesel range organics (DRO) and gasoline range organics (GRO), USEPA Target Analyte List (TAL) metals, hexavalent chromium, and cyanide. During the implementation of the Parcel B6 Work Plan, TPH-DRO/GRO analysis was

required at every location, but Oil & Grease analysis was not required or completed. Only select locations (B6-089-SB and B6-093-SB) were additionally analyzed for Oil & Grease because these borings were completed after the new requirements for Oil & Grease analysis were established. Shallow soil samples (0 to 1 foot bgs) were additionally analyzed for polychlorinated biphenyls (PCBs). The laboratory Certificates of Analysis (including Chains of Custody) and relevant Data Validation Reports (50% validated soil data) are included as electronic attachments. The Data Validation Reports contain qualifier keys for the flags assigned to individual results in the attached summary tables.

Soil sample results were screened against the Project Action Limits (PALs) established in the property-wide Quality Assurance Project Plan (QAPP) dated April 5, 2016, or based on other direct agency guidance (e.g., TPH/Oil & Grease). **Table 1** and **Table 2** provide summaries of the detected organic compounds and inorganics in the soil samples collected from the 19 soil borings relevant for this Site evaluation. **Figure SB1** and **Figure SB2** present the soil sample results that exceeded the PALs among these soil borings. The PALs for relevant polynuclear aromatic hydrocarbons (PAHs) have been adjusted upward based on revised toxicity data published in the USEPA Regional Screening Level (RSL) Composite Worker Soil Table. PAL exceedances among the Phase II Investigation soil samples relevant for the proposed development project were limited to five inorganics (arsenic, lead, manganese, thallium, and vanadium) and one SVOC (benzo[a]pyrene). There were no observations of physical evidence of non-aqueous phase liquid (NAPL) during field screening of the soil borings within, or proximate to, the Site.

3.2.2 Phase II Groundwater Investigation Findings

Groundwater conditions were investigated in accordance with the Finishing Mills Groundwater Investigation Work Plan. Shallow groundwater samples were obtained from four temporary groundwater sample collection points (piezometers) and three permanent monitoring wells within, or in close proximity to, Sub-Parcel B6-3. The seven shallow groundwater points which provided relevant analytical data for the proposed development project are shown on **Figure 5**. There is no direct exposure risk for future Composite Workers at the Site because there is no use of groundwater on the Tradepoint Atlantic property; however, groundwater may be encountered in the sub-parcel during some construction tasks. If groundwater is encountered during development, it will be managed to prevent exposures in accordance with the dewatering requirements outlined in Section 5.2.

The groundwater samples were analyzed for TCL-VOCs, TCL-SVOCs, TAL-dissolved metals, TPH-DRO/GRO, hexavalent chromium, and total cyanide. Permanent groundwater wells were additionally analyzed for TAL-total metals. Groundwater samples submitted for analysis of dissolved metals were filtered in the field with an in-line 0.45 micron filter. Oil & Grease analysis was not required or completed during the Finishing Mills Groundwater Phase II Investigation.

Hexavalent chromium is typically analyzed via USEPA Method 7196A, which is a colorimetric method. All hexavalent chromium samples in the Finishing Mills Groundwater Phase II Investigation were initially collected as total hexavalent chromium. However, high turbidities present in some unfiltered samples resulted in a matrix interference with this colorimetric method. Due to an elevated result reported for total hexavalent chromium which was considered to be suspect, FM-008-PZS was resampled using low-flow techniques on July 5, 2016 to be analyzed for total hexavalent chromium again by method 7196A and by an alternative method (7199). The data for total hexavalent chromium from the July 5, 2016 sampling event were used in lieu of the original data from the sample with high turbidity. On July 15, 2016, FM-008-PZS was again resampled (along with others in the Finishing Mills Area) to be analyzed for dissolved hexavalent chromium via USEPA Method 7196A. These resampling events were also reported within the Finishing Mills Groundwater Phase II Investigation Report.

The laboratory Certificates of Analysis (including Chains of Custody) and relevant Data Validation Reports (50% validated groundwater data) are included as electronic attachments. The Data Validation Reports contain qualifier keys for the flags assigned to individual results in the attached summary tables.

The Phase II Investigation shallow groundwater results were screened against the PALs established in the property-wide QAPP dated April 5, 2016, or based on other direct agency guidance (e.g., TPH). **Table 3** and **Table 4** provide summaries of the detected organic compounds and inorganics in the groundwater samples submitted for laboratory analysis, and **Figure GW1** presents the groundwater results that exceeded the PALs. Similar to the evaluation of soil data, the PALs for relevant PAHs have been adjusted upward based on revised toxicity data published in the USEPA RSL Resident Tapwater Table. PAL exceedances among the Phase II Investigation shallow groundwater samples collected in the vicinity of the proposed development project consisted of one VOC (1,1-dichloroethane), one SVOC (naphthalene), TPH-DRO, and five total/dissolved metals (hexavalent chromium, cobalt, manganese, thallium, and vanadium). Each groundwater collection point was also inspected for evidence of NAPL using an oil-water interface probe prior to sampling. None of the groundwater sample collection points relevant for the proposed development project showed evidence of NAPL during these checks.

3.2.3 Locations of Potential Concern

There are no concerns related to potential vapor intrusion (VI) risks/hazards with respect to the proposed future use of the Site. Total cyanide had previously been identified as a potential VI risk in the Finishing Mills Groundwater Phase II Investigation Report, but the screening level for cyanide has since been adjusted upward by the USEPA, eliminating this concern.

Other locations of potential concern which are subject to special requirements could include elevated lead, PCBs, or TPH/Oil & Grease in soil. The soil data relevant for Sub-Parcel B6-3 were evaluated to determine the presence of any such locations of potential concern including: lead

concentrations above 10,000 mg/kg, PCB concentrations above 50 mg/kg, or TPH/Oil & Grease concentrations above 6,200 mg/kg. There were no soil concentrations of lead, PCBs, or TPH/Oil & Grease above the specified criteria.

Locations with physical evidence of NAPL are also considered to be locations of potential concern with respect to proposed development. None of the groundwater sample collection points included in the Finishing Mills Groundwater Phase II Investigation exhibited evidence of NAPL. During field screening of the soil cores for the original Parcel B6 Phase II investigation, there were no locations with observations of physical evidence of NAPL within, or in close proximity to, the development sub-parcel.

3.3 HUMAN HEALTH SCREENING LEVEL RISK ASSESSMENT

3.3.1 Analysis Process

A human health Screening Level Risk Assessment (SLRA) has been completed based on the analytical data obtained from the characterization of surface and subsurface soils. This includes the soil data obtained during the preceding Parcel B6 Phase II Investigation (discussed in Section 3.2.1). It should be noted that processed slag aggregate sourced from the Tradepoint Atlantic property will be used as the primary fill material and pavement subbase for this project; therefore, regardless of the findings of the Composite Worker baseline assessment, Sub-Parcel B6-3 will be subject to surface engineering controls (i.e., capping) unless separate approvals are received from the MDE following appropriate laboratory testing of the slag aggregate. The SLRA was conducted to further evaluate the existing soil conditions in support of the design of any additional necessary response measures.

The SLRA included the following evaluation process:

Identification of Exposure Units (EUs): The Composite Worker SLRA was evaluated using a single site-wide EU (designated as EU1) with an area of 30.3 acres covering the entirety of Sub-Parcel B6-3. The Construction Worker SLRA was evaluated using a slightly expanded EU (designated as EU1-EXP), covering 31.0 acres in total which includes the additional construction worker areas incorporated within the LOD to include the facility entrance and utility connections outside of the sub-parcel. Two soil borings (B6-081-SB and B6-082-SB) positioned along the utility easements to the north of the main development area were not included in EU1 for the Composite Worker evaluation but were included in EU1-EXP for the Construction Worker evaluation.

Identification of Constituents of Potential Concern (COPCs): For the project-specific SLRA, compounds that were present at concentrations at or above the USEPA RSLs set at a target cancer risk of $1E-6$ or target non-cancer Hazard Quotient (HQ) of 0.1 were identified as COPCs to be included in the SLRA. A COPC screening analysis is provided in **Table 5** to identify all compounds above the relevant screening levels.

Exposure Point Concentrations (EPCs): The COPC soil datasets for the site-wide EU1 and EU1-EXP were divided into surface (0 to 1 foot), subsurface (>1 foot), and pooled depths for estimation of potential EPCs. Thus, there are three soil datasets associated with each EU. A statistical analysis was performed for each COPC dataset using the ProUCL software (version 5.0) developed by the USEPA to determine representative reasonable maximum exposure (RME) values for the EPC for each constituent. The RME value is typically the 95% Upper Confidence Limit (UCL) of the mean. For lead, the arithmetic mean for each depth was calculated for comparison to the Adult Lead Model (ALM)-based values, and any individual results exceeding 10,000 mg/kg would be delineated for possible excavation and removal (if applicable). For PCBs, all results equaling or exceeding 50 mg/kg would be delineated for excavation and removal (if applicable).

Risk Ratios: The surface soil EPCs, subsurface soil EPCs, and pooled soil EPCs were compared to the USEPA RSLs for the Composite Worker and to site-specific Soil Screening Levels (SSLs) for the Construction Worker based on equations derived in the USEPA Supplemental Guidance for Developing Soil Screening Levels for Superfund Sites (OSWER 9355.4-24, December 2002). Risk ratios were calculated with a cancer risk of $1E-6$ and a non-cancer HQ of 1. The risk ratios for the carcinogens were summed to develop a screening level estimate of the baseline cumulative cancer risk. The risk ratios for the non-carcinogens were segregated and summed by target organ to develop a screening level estimate of the baseline cumulative non-cancer Hazard Index (HI).

For the Construction Worker, site-specific risk-based evaluations were completed for a range of potential exposure frequencies to determine the maximum exposure frequency for the site-wide EU1-EXP that would result in risk ratios equivalent to a cumulative cancer risk of $1E-5$ or HI of 1 for the individual target organs. This analysis indicated that the allowable exposure frequency before additional worker protections or more detailed job safety evaluations might be needed is 25 days.

There is no potential for direct human exposure to groundwater for a Composite Worker since groundwater is not used on the Tradepoint Atlantic property (and is not proposed to be utilized). In the event that construction/excavation leads to a potential Construction Worker exposure to groundwater during development, health and safety plans and management procedures shall be followed to limit exposure risk.

Assessment of Lead: For lead, the arithmetic mean concentrations for surface soils, subsurface soils, and pooled soils were compared to the applicable RSL (800 mg/kg) as an initial screening. If the mean concentrations for the EU were below the applicable RSL, the EU was identified as requiring no further action for lead. If a mean concentration exceeded the RSL, the mean values were compared to calculated ALM values (ALM Version dated 6/21/2009 updated with the 5/17/2017 OLEM Directive) with inputs of 1.8

for the geometric standard deviation and a blood baseline lead level of 0.6 ug/dL. The ALM calculation generates a soil lead concentration of 2,518 mg/kg, which is the most conservative (i.e., lowest) concentration which would yield a probability of 5% of a blood lead concentration of 10 ug/dL. If the arithmetic mean concentrations for the EU were below 2,518 mg/kg, the EU was identified as requiring no further action for lead. The lead averages and ALM screening levels are presented for surface, subsurface, and pooled soils in **Table 6**. Any individual results equaling or exceeding 10,000 mg/kg of lead would warrant additional delineation for possible excavation (if applicable).

Assessment of TPH/Oil & Grease: EPCs were not calculated for TPH/Oil & Grease. Instead, the individual results were compared to the PAL set to a HQ of 1 (6,200 mg/kg). No soil samples exceeded the PAL for TPH/Oil & Grease. Potential evidence of NAPL was not observed at any soil boring locations relevant for the proposed development. Contingency measures to address the potential presence of NAPL which could be encountered during construction are addressed in subsequent sections of this RADWP.

Risk Characterization Approach: Generally, if the baseline risk ratio for each non-carcinogenic COPC or cumulative target organ does not exceed 1 (with the exception of lead), and the sum of the risk ratios for the carcinogenic COPCs does not exceed a cumulative cancer risk of 1E-5, then a no further action determination will be recommended. If the baseline estimate of cumulative cancer risk exceeds 1E-5 but is less than or equal to 1E-4, then capping of the EU will be considered to be an acceptable remedy for the Composite Worker. For the Construction Worker, cumulative cancer risks exceeding 1E-5, but less than or equal to 1E-4, will be mitigated via site-specific health and safety requirements. The efficacy of capping for elevated non-cancer hazard will be evaluated in terms of the magnitude of exceedance and other factors such as bioavailability of the COPC.

Due to the grading activities including cut and fill which will be implemented during development at the Site, the SLRA was evaluated to determine baseline Composite and Construction Worker exposures to surface, subsurface, and pooled data. It should be noted that processed slag aggregate sourced from the Tradepoint Atlantic property will be used as the primary fill material and pavement subbase for this project; therefore, regardless of the findings of the Composite Worker baseline assessment, Sub-Parcel B6-3 will be subject to surface engineering controls (i.e., capping) unless separate approvals are received from the MDE following appropriate laboratory testing of the slag aggregate material. The goal of the SLRA is therefore to determine whether additional response actions beyond capping may be needed due to current conditions at the Site. It should be noted that processed slag aggregate has already been placed in the vicinity of the proposed warehouse in accordance with the approved Logistics Center Grading Plan (Revision 0 dated March 3, 2020).

The USEPA's acceptable risk range is between 1E-6 and 1E-4. If the sum of the risk ratios for carcinogens exceeds a cumulative cancer risk of 1E-4, further analysis of site conditions will be required including the consideration of toxicity reduction in any proposal for a remedy. The magnitude of any non-carcinogen HI exceedances and bioavailability of the COPC will also dictate further analysis of site conditions including consideration of toxicity reduction in any proposal for a remedy. For lead, if the ALM results indicate that the mean concentrations would present a 5% to 10% probability of a blood concentration of 10 ug/dL for the EU, then capping of the EU would be an acceptable presumptive remedy. The mean soil lead concentrations corresponding to ALM probabilities of 5% and 10% are 2,518 mg/kg and 3,216 mg/kg, respectively. If the ALM indicates that the mean concentrations would present a >10% probability of a blood concentration of 10 ug/dL for the EU, further analysis of site conditions including toxicity reduction will be completed such that the probability would be reduced to less than 10% after toxicity reduction, but before capping.

3.3.2 Sub-Parcel B6-3 SLRA Results and Risk Characterization

Soil data were divided into three datasets (surface, subsurface, and pooled) for Sub-Parcel B6-3 to evaluate potential exposure scenarios. Due to the grading activities including cut and fill which will be implemented during development at the Site, each of these potential exposure scenarios is relevant for both the Composite and Construction Worker.

EPCs were calculated for each soil dataset (i.e., surface, subsurface, and pooled surface/subsurface) in the site-wide EU1 and EU1-EXP. ProUCL output tables (with computed UCLs) derived from the data for each COPC in soils are provided as electronic attachments, with computations presented and EPCs calculated for COPCs within each of the datasets. The ProUCL input tables are also included as electronic attachments. The results were evaluated to identify any samples that may require additional assessment or special management based on the risk characterization approach. The calculated EPCs for the surface, subsurface, and pooled exposure scenarios are provided in **Table 7**.

As indicated above, the EPCs for lead are the average (i.e., arithmetic mean) values for each dataset. A lead evaluation spreadsheet, providing the computations to determine lead averages for each dataset, is also included as an electronic attachment. The average lead concentrations are presented for each dataset in **Table 6**, which indicates that neither surface, subsurface, nor pooled soils exceeded an average lead value of 800 mg/kg. The screening criterion for lead was set at an arithmetic mean of 800 mg/kg based on the RSL, with a secondary limit of 2,518 mg/kg based on the May 2017 updated ALM developed by the USEPA (corresponding to a 5% probability of a blood lead level of 10 ug/dL). There were no locations with lead detections above 10,000 mg/kg.

None of the detections of PCBs included in the project-specific SLRA evaluation exceeded the mandatory excavation criterion of 50 mg/kg.

Composite Worker Assessment:

Risk ratios for the estimates of potential EPCs for the Composite Worker baseline scenario prior to the placement of slag aggregate at the Site are shown in **Table 8** (surface), **Table 9** (subsurface), and **Table 10** (pooled). The results are summarized as follows:

Worker Scenario	Exposure Unit	Medium	Hazard Index (>1)	Total Cancer Risk
Composite Worker	EU1 (30.3 acres)	Surface Soil	Dermal = 2	6E-6
		Subsurface Soil	Dermal = 5 Nervous = 2	4E-6
		Pooled Soil	Dermal = 2	3E-6

Based on the risk ratios for Sub-Parcel B6-3, environmental capping (100% of the Site) is an acceptable remedy to be protective of future Composite Workers for the surface, subsurface, and pooled exposure scenarios. None of the carcinogenic risk estimates for the Composite Worker were greater than the acceptable risk level of 1E-5 or the secondary risk level of 1E-4 which would warrant consideration of toxicity reduction. Each scenario exceeded the non-cancer HI value of 1 for at least one target organ system (each scenario exceeded the HI value of 1 for the dermal system target organ and the subsurface soil scenario exceeded the HI value of 1 for the nervous system target organ). The proposed capping remedy will provide adequate protection from these HI threshold exceedances. Capping and institutional controls (to maintain the integrity of the cap) are suitable measures for the protection of the future Composite Worker for both cancer risks and non-cancer hazards. The capping remedy will additionally be protective of slag aggregate which will be used as the primary fill material and pavement subbase at the Site.

Construction Worker Assessment:

According to the work schedule provided by Tradepoint Atlantic, intrusive activities which could result in potential Construction Worker exposures are expected to be limited to four primary utility installation tasks:

- Domestic Water/Fire Loop: 4 weeks (20 exposure days) estimated
- Sanitary: 2 weeks (10 exposure days) estimated
- Stormwater: 6 weeks (30 exposure days) estimated
- Pond Excavation and Grading: 4 weeks (20 exposure days) estimated

Although the anticipated work period may be subject to change (see schedule in Section 7.0), the duration of these activities is not expected to increase. Construction Worker risks were evaluated for several exposure scenarios to determine the maximum exposure frequency for the side-wide

EU1-EXP (which includes the additional construction worker areas as noted above) that would result in risk ratios equivalent to a cumulative cancer risk of 1E-5 or HI of 1 for any individual target organ. Risk ratios for the estimates of potential EPCs for the Construction Worker scenario using the selected duration (25 work days) are shown in **Table 11** (surface), **Table 12** (subsurface), and **Table 13** (pooled). The variables entered for calculation of the site-specific Construction Worker SSLs (EU area, input assumptions, and exposure frequency) are indicated as notes on the tables. The spreadsheet used for computation of the site-specific Construction Worker SSLs is included in **Appendix B**. The results are summarized as follows:

Worker Scenario	Exposure Unit	Medium	Hazard Index (>1)	Total Cancer Risk
Construction Worker	EU1-EXP (31.0 acres) (25 exposure days)	Surface Soil	none	9E-8
		Subsurface Soil	none	7E-8
		Pooled Soil	none	6E-8

Using the selected exposure duration of 25 days, the carcinogenic risks were all less than 1E-5, and none of the non-carcinogens caused a cumulative HI to exceed 1 for any target organ system. These findings are below the acceptable limits for no further action established by the agencies. This evaluation indicates that additional site-specific health and safety requirements (beyond standard Level D protection) would be required only if the allowable exposure duration of 25 days were to be exceeded for an individual worker.

Certain activities at the Site (utility installations for specific crews as noted above) are anticipated to exceed the allowable duration, and Construction Worker risks must be mitigated to facilitate the proposed construction work. Additional site-specific health and safety requirements are warranted to be protective of workers. Upgraded Personal Protective Equipment (PPE) beyond standard Level D protection will be used for the entire scope of intrusive work covered by this RADWP as a protective measure to ensure that there are no unacceptable exposures for Construction Workers during project implementation. The modified Level D PPE requirements which will be applied immediately and throughout this project, including specific PPE details, planning, tracking/supervision, enforcement, and documentation, are outlined in the PPE Standard Operational Procedure (SOP) provided as **Appendix C**.

Institutional controls will be required to be established for the protection of future Construction Workers in the event of any future long-term construction projects which could include intrusive activities. The anticipated institutional controls, including notification requirements, health and safety requirements, and materials management requirements, are specified in Section 5.4.

3.3.3 Evaluation of Comprehensive Environmental Response, Compensation, and Liability Act Criteria

Results from the SLRA indicate that a site-wide remedy of capping with institutional controls will be acceptable to mitigate potential current and future Composite Worker risks resulting from on-site soil conditions. Site-specific health and safety controls will be implemented to mitigate Construction Worker risks within the sub-parcel. This includes using modified Level D PPE. The modified Level D PPE requirements will be implemented throughout the project duration in accordance with the PPE SOP provided as **Appendix C**. Institutional controls will also be required to be established for the protection of future Construction Workers in the event of any future long-term construction projects which could include intrusive activities.

The proposed VCP capping remedy with institutional controls was evaluated for consistency with the Comprehensive Environmental Response, Compensation, and Liability Act (CERCLA) Threshold Criteria and the Balancing Criteria. The Threshold Criteria assess the overall protection of human health and the environment, as well as achievement of media cleanup objectives and control of sources of releases at the Site. The Balancing Criteria assess long-term effectiveness and permanence; reduction of toxicity, mobility or volume; short-term effectiveness; implementability; cost effectiveness; and community and State acceptance.

Threshold Criteria:

Protect Human Health and the Environment: The assessment against this criterion evaluates how the remedy, as a whole, protects and maintains protection of human health and the environment. This criterion is satisfied when response actions are complete. The purpose of this remedy is to provide a protective barrier between human site users and impacted materials, and to protect the environment by preventing surface water from contacting potentially impacted materials in place. The capping and institutional control remedy would eliminate risk to current and future industrial workers by preventing exposure to areas of the Site where processed slag aggregate has been placed or where soil concentrations exceed a cancer risk of $1E-5$ or a HI of 1. Groundwater does not present a direct human health hazard since there is no groundwater use on the property. Implementation of the proposed use restrictions will address the residual risk and will also protect future workers by eliminating or controlling potential exposure pathways, thus, reducing potential intake and contact of soil/groundwater COPCs by human receptors.

Achieve Media Cleanup Objective: The assessment against this criterion describes how the remedy meets the cleanup objective, which is risk reduction, appropriate for the expected current and reasonably anticipated future land use. The objective is to protect current/future Composite Workers and Construction Workers from potential exposures to COPCs present in soil or groundwater at levels that may result in risks of adverse health effects. Given the controlled access and use restrictions, the proposed remedy will attain

soil and groundwater objectives. The activity use restrictions will eliminate current and future unacceptable exposures to both soil and groundwater.

Control the Source of Releases: In its RCRA Corrective Action proposed remedies, USEPA seeks to eliminate or reduce further releases of hazardous wastes or hazardous constituents that may pose a threat to human health and the environment. Controlling the sources of contamination relates to the ability of the proposed remedy to reduce or eliminate, to the maximum extent practicable, further releases. Sampling results did not indicate localized, discernible source areas associated with the soil conditions observed at the Site. The control measures included in the proposed remedy, such as Materials Management Plan requirements and groundwater use restrictions, provide a mechanism to control and reduce potential further releases of COPCs. This is achieved by eliminating the potential for groundwater use and requiring proper planning for intrusive activities.

Balancing Criteria:

Long-Term Reliability and Effectiveness: The assessment against this criterion evaluates the long-term effectiveness of the remedy in maintaining protection of human health and the environment after the response objectives have been met. The primary focus of this criterion is the extent and effectiveness of the controls that may be required to manage the risk posed by slag aggregate, treatment residuals, and/or untreated wastes. The proposed capping remedies have been proven to be effective in the long-term at similar sites with similar conditions. The capping remedy will permanently contain the slag aggregate and other potentially contaminated media in place. In order for the cap to effectively act as a barrier, regular inspections will be required to determine if erosion or cracks have formed that could expose workers to contaminated materials.

Institutional controls will be implemented to protect future Composite and Construction Workers against inadvertent contact with potentially impacted media. The anticipated institutional controls are specified in Section 5.4. The Tenant will be required to sign onto the Environmental Covenant with restriction in the NFA. The proposed remedy will maintain protection of human health and the environment over time by controlling exposures to the hazardous constituents potentially remaining in slag aggregate or existing on-site media. The long-term effectiveness is high, as use restrictions are readily implementable and easily maintained. Given the historical, heavily industrial uses of the Site and the surrounding area, including the presence of landfills, land and groundwater use restrictions are expected to continue in the long term.

Reduction of Toxicity, Mobility, or Volume of Waste: The assessment against this criterion evaluates the anticipated performance of specific technologies that a remedial action alternative may employ. The capping remedy will prevent the spread of contaminants in wind-blown dust or stormwater and will prevent infiltration through the

unsaturated zone from carrying contaminants to the groundwater. Thus, the mobility of contaminants will be reduced by the capping remedy.

Short-term Effectiveness: The assessment against this criterion examines how well the proposed remedy protects human health and the environment during the construction and implementation until response objectives have been met. This criterion also includes an estimate of the time required to achieve protection for either the entire site or individual elements associated with specific site areas or threats. The risks to the Construction Worker during remedy implementation are mitigated by executing the modified Level D PPE requirements outlined in **Appendix C**. The short-term risk to site workers following these upgraded health and safety measures during implementation of the remedy will be low, leading to a high level of short-term effectiveness for protection of future site users and the environment. Short-term effectiveness in protecting on-site workers and the environment will be achieved through establishing appropriate management, construction, health and safety, and security procedures. Proper water management protocols will be implemented to prevent discharges offsite. Security and fences will be used to maintain controlled access during construction.

Implementability: The assessment against this criterion evaluates the technical and administrative feasibility, including the availability of trained and experienced personnel, materials, and equipment. Technical feasibility includes the ability to construct and operate the technology, the reliability of the technology, and the ability to effectively monitor the technology. Administrative feasibility includes the capability of obtaining permits, meeting permit requirements, and coordinating activities of governmental agencies. The proposed capping remedy for the Composite Worker area will use readily available, typically acceptable, and proven technologies.

Cost Effectiveness: The assessment against this criterion evaluates the capital costs, annual Operating and Maintenance (O&M) costs, and the net present value (NPV) of this remedy relative to alternatives. The capping remedy remedial costs would be incurred as part of the proposed site development, regardless of the findings of the SLRA.

State Support / Agency Acceptance: MDE has been involved throughout the Site investigation process. The proposed use restrictions included in the proposed remedy are generally recognized as commonly employed measures for long-term stewardship. Ultimately State/MDE support will be evaluated based on comments received during the public comment period.

A capping remedy with institutional controls would satisfy the CERCLA Threshold Criteria and the Balancing Criteria and would do so in a manner that ensures reliable implementation and effectiveness. The remedy is cost-effective and consistent with the proposed development plan.

4.0 PROPOSED SITE DEVELOPMENT PLAN

Tradepoint Atlantic is proposing to construct a logistics center totaling approximately 400,000 square feet on Sub-Parcel B6-3. The proposed development will include permanent improvements on approximately 30.3 acres of land intended for occupancy within Parcel B6. The proposed future use of Sub-Parcel B6-3 is Tier 3 – Industrial. The remainder of Parcel B6 will be addressed in separate development plans in accordance with the requirements of the ACO that will include RADWPs, if necessary. Outside of the main development area, temporary construction zones with a total area of approximately 0.7 acres will be utilized to install the facility entrance and subgrade utility connections for the project. The temporary work outside of the boundary of the Site is not intended to be the basis for the issuance of a NFA or a COC, although the scope of construction work is covered by this RADWP. The Site (30.3 acres encompassing Sub-Parcel B6-3; excluding the temporary construction zones) will be fully capped by surface engineering controls.

Certain compounds are present in the soils located near the surface and in the subsurface at concentrations in excess of the PALs. Therefore, soil is considered a potential media of concern. Potential risks to future adult workers associated with impacts to soil and groundwater exceeding the PALs will be addressed through a remedy consisting of surface engineering controls (capping of the entire area) and institutional controls (deed restrictions). The development plan provides for a containment remedy and institutional controls that will mitigate future adult workers from contacting impacted soil at the Site. In addition, Tradepoint Atlantic has proposed the use of processed slag aggregate as the primary fill material and pavement subbase at the Site. The placement of materials other than approved clean fill, including slag aggregate, requires the installation of surface engineering controls regardless of the existing soil conditions.

Future Construction Workers may contact impacted surface and/or subsurface soil during earth movement activities associated with construction activities, including within the temporary construction zones outside of the primary development area. The findings of the Construction Worker SLRA indicated that using the site-specific 25-day exposure frequency for the site-wide EU1-EXP, the screening level estimates of Construction Worker cancer risk were less than $1E-5$ and no HI values above 1 were identified for any target organ system (the acceptable thresholds for no further action).

Certain activities at the Site are anticipated to exceed the allowable duration, and Construction Worker risks must be mitigated to facilitate the proposed construction work. Additional site-specific health and safety requirements are warranted to be protective of workers. Upgraded PPE beyond standard Level D protection will be used in conjunction with the property-wide Health and Safety Plan (HASP) for the entire scope of intrusive work covered by this RADWP as a protective measure to ensure that there are no unacceptable exposures for Construction Workers during project implementation. The modified Level D PPE requirements which will be applied throughout this project, including specific PPE details, planning, tracking/supervision, enforcement, and documentation, are outlined in the PPE SOP provided as **Appendix C**.

A restriction prohibiting the use of groundwater for any purpose at the Site will be included as an institutional control in the NFA and COC issued by the MDE, and a deed restriction prohibiting the use of groundwater will be filed. The groundwater use restriction will protect future Composite Workers from potential direct exposures. Proper water management is required to prevent unacceptable discharges or risks to Construction Workers during development. Work practices and health and safety plans governing groundwater encountered during excavation activities will provide protection for Construction Workers involved with development at the Site.

The development plan for the Site is shown on **Figure 2** and **Figure 3**, and the detailed development drawings (provided by Bohler Engineering) are included as **Appendix D**. The process of constructing the proposed logistics center will involve the tasks listed below. Documentation of the outlined tasks and procedures will be provided in a Sub-Parcel B6-3 Development Completion Report. The Development Completion Report will also cover the initial grading (site preparation) work that was described and approved within the Logistics Center Grading Plan (Revision 0 dated March 3, 2020) which preceded this RADWP.

4.1 RESPONSE PHASE – GROUNDWATER NETWORK ABANDONMENT

Permanent groundwater monitoring wells SW-076-MWS, SW-076-MWI, SW-080-MWS, and SW-080-MWI are located inside the development boundary as shown on **Figure 6**. The identified groundwater monitoring wells were sampled during the Finishing Mills Groundwater Phase II Investigation, with the results presented and discussed in the associated Phase II Investigation Report. As part of this development project, these four monitoring wells will be properly abandoned in accordance with COMAR 26.04.04.34 through 36. Several temporary groundwater sample collection points were also installed within and surrounding the Site at the locations shown on **Figure 6** but have already been properly abandoned.

The abandonment of any permitted groundwater wells must be reported to the Water Management Administration as per COMAR 26.04.04, and records of all groundwater well and piezometer abandonments (including abandonment forms, if available) will be included in the Development Completion Report. It is understood that the agencies may require the installation of additional permanent monitoring wells in the future following site development.

4.2 DEVELOPMENT PHASE

4.2.1 Erosion and Sediment Control Installation

Installation of erosion and sediment controls will be completed in accordance with the requirements of the 2011 Maryland Standards and Specifications for Soil Erosion and Sediment Control prior to construction at the Site. Any soils which are disturbed during the installation of erosion and sediment controls will be replaced on-site below the cap.

4.2.2 Grading and Site Preparation

As indicated on the development plans in **Appendix D**, grading activities including both cut and fill will occur within the Sub-Parcel B6-3 boundary. The preceding Logistics Center Grading Plan (Revision 0 dated March 3, 2020) was submitted to allow Tradepoint Atlantic to proceed with grading (site preparation) for the future construction of the warehouse building designated as Logistics Center VI. The work proposed within the Grading Plan was limited to the footprint of the proposed warehouse building and the immediately surrounding area, and it did not include the full scope of grading work required to facilitate development of Sub-Parcel B6-3.

Any material that is not suitable for compaction will be excavated and replaced with subbase material, although it is not anticipated that poor soils will be encountered. Borrow materials will be obtained from MDE-approved sources and will be documented prior to transport to the Site. Processed slag aggregate sourced from the Tradepoint Atlantic property or other materials approved by the MDE for industrial use may be used as fill, but the placement of materials other than approved clean fill will necessitate that the Site will be subject to surface engineering controls (i.e., capping). Fill sources shall be free of organic material, frozen material, or other deleterious material. In the case that there is excess material (not anticipated), the spoils will be stockpiled at a suitable location in accordance with the Materials Management Plan (MMP) for the Sparrows Point Facility (Papadopoulos & Associates, et al., June 17, 2015). This work will be coordinated with MDE accordingly. No excess material will leave the 3,100-acre property without prior approval from MDE.

4.2.3 Installation of Structures and Underground Utilities

The logistics center building, parking lots, and other infrastructure associated with the development of Sub-Parcel B6-3 will be installed as shown on the drawings in **Appendix D**. Soils relocated or removed during construction may be replaced on-site below the cap, but soil removed from utility trenches cannot be used as fill within the utility trenches unless such materials are approved for this use by the VCP. Additional protocols for the installation of utilities at the Site are provided in Section 5.1.2. Any water removed will be sampled (if necessary) as described in Section 5.2 and (if acceptable) sent to the on-site Humphrey Creek Wastewater Treatment Plant (HCWWTP).

4.2.4 Floor Slabs and Paving

Much of the Site will be covered with floor slabs or paving as indicated in the development plans provided in **Appendix D**. The paved areas will receive a layer of subbase material which will consist of compacted aggregate base, which may include processed slag aggregate sourced from the Tradepoint Atlantic property. The placement of processed slag aggregate or materials other than MDE-approved clean fill will necessitate that the Site will be subject to surface engineering controls (i.e., capping).

The required minimum thicknesses of all site-wide pavement sections which will serve as surface engineering controls are shown in the minimum capping section details provided in **Appendix E**. According to the development plans, all paved areas at the Site will be installed with a minimum of 4 inches of compacted aggregate base and a minimum of 4 inches of overlying pavement surface (asphalt or concrete), which meet these required minimum thicknesses.

4.2.5 Landscaping

The areas marked as “Proposed Area to be Landscaped” on the development plans (**Appendix D**) will be covered by landscaped caps. Additionally, any undesignated areas within the Site boundary will also be covered with landscaped caps. Tradepoint Atlantic has confirmed that this will include the narrow undesignated area along the southeastern edge of the Site at Sparrows Point Boulevard as well as the undesignated area at the northeastern corner of the Site.

The required minimum thicknesses of all site-wide landscaping sections which will serve as surface engineering controls are shown in the minimum capping section details provided in **Appendix E**. According to the development plans, all landscaped areas at the Site will be installed with a minimum of 6 inches of clean topsoil overlying 18 inches of clean fill, with an underlying geotextile marker fabric between the clean fill and the existing underlying material. The proposed landscape sections for the Site meet the minimum capping requirements.

4.2.6 Stormwater Management

The proposed stormwater utility layout for the Site is provided on the development plan drawings in **Appendix D**. New stormwater infrastructure will be installed throughout the Site and will discharge to two new stormwater ponds. The required minimum thicknesses of all pond sections which will serve as surface engineering controls are shown in the minimum capping section details provided in **Appendix E**. According to the development plans, the stormwater ponds will be installed with an impermeable PVC liner between the existing soil (or fill) and 1 foot of overlying clean fill. The proposed pond sections for the Site meet the minimum capping requirements.

Based on the shallow groundwater elevation measurements collected during the Finishing Mills Groundwater Phase II Investigation, the pond excavations may encounter groundwater. As shown on **Figure 7**, the shallow groundwater elevations underlying the eastern stormwater pond and southern stormwater pond are at approximately 11 feet amsl (similar to the pond bottom elevation) and 7 feet amsl (4 feet below the pond bottom), respectively. Any water removed will be sampled (if necessary) as described in Section 5.2 and (if acceptable) sent to the on-site HCWWTP.

Tradepoint Atlantic is working with the MDE Industrial & General Permits Division to renew the property-wide NPDES permit. The stormwater management systems for each parcel are reviewed and approved by Baltimore County for each individual development project.

5.0 DEVELOPMENT IMPLEMENTATION PROTOCOLS

5.1 DEVELOPMENT PHASE

This plan presents protocols for the handling of soils and fill materials in association with the development of Sub-Parcel B6-3. In particular, this plan highlights the minimum standards for construction practices and managing potentially contaminated materials to reduce potential risks to workers and the environment.

Several exceedances of the PALs were identified in soil samples across the Site. The PALs are set based on USEPA's RSLs for industrial soils, or other direct guidance from the MDE. Because PAL exceedances can present potential risks to human health and the environment at certain concentrations, this plan presents material management and other protocols to be followed during the work to adequately mitigate potential risks from such materials remaining on-site during the development phase. There were no locations in the proposed Site boundary with soil exceedances of the special management criteria for PCBs (50 mg/kg), lead (10,000 mg/kg), or TPH/Oil & Grease (6,200 mg/kg). NAPL was not identified at any soil boring locations or groundwater sample collection points relevant for the Site.

Following completion of the SLRA, the findings of the Construction Worker evaluation indicated that using the site-specific 25-day exposure frequency for the site-wide EU1-EXP, the screening level estimates of Construction Worker cancer risk were less than 1E-5 and no HI values above 1 were identified for any target organ system (the acceptable thresholds for no further action). Certain activities at the Site are anticipated to exceed the allowable duration of 25 days, and Construction Worker risks must be mitigated to facilitate the proposed construction. Upgraded PPE beyond standard Level D protection will be used in conjunction with the HASP for the entire scope of intrusive work covered by this RADWP as a protective measure to ensure that there are no unacceptable exposures for Construction Workers during project implementation. The modified Level D PPE requirements which will be applied throughout this project, including specific PPE details, planning, tracking/supervision, enforcement, and documentation, are outlined in the PPE SOP provided as **Appendix C**.

Based on the characterization of surface and subsurface soils and the associated SLRA findings, surface engineering controls are an acceptable remedy to be protective of future adult Composite Workers who otherwise could potentially contact surface soil (or relocated subsurface soil) at the Site. In addition, Tradepoint Atlantic has proposed the use of processed slag aggregate as the primary fill material and pavement subbase at the Site. The placement of materials other than approved clean fill, including slag aggregate, requires the installation of surface engineering controls (i.e., capping) regardless of the existing soil conditions. The proposed capping sections will meet the required minimum thicknesses for surface engineering controls, which are provided in **Appendix E**.

5.1.1 Erosion/Sediment Control

Erosion and sediment controls will be installed prior to commencing work in accordance with the 2011 Maryland Standards and Specifications for Soil Erosion and Sediment Control. The erosion and sediment controls will be approved by the MDE. In addition, the following measures will be taken to prevent contaminated soil from exiting the Site:

- Stabilized construction entrance will be placed at site entrance.
- A dry street sweeper will be used as necessary on adjacent roads, and the swept dust will be collected and properly managed.
- Accumulated sediment removed from silt fence, and sediment traps if applicable, shall be periodically removed and returned to the Site.

5.1.2 Soil Excavation and Utility Trenching

A pre-excavation meeting shall be held to address proper operating procedures for working on-site and monitoring excavations and utility trenching in potentially contaminated material. This meeting shall include the construction manager and the EP providing oversight on the project. During the meeting, the construction manager and the EP shall review the proposed excavation/trenching locations and any associated utility inverts. The construction manager will be responsible for conveying all relevant information regarding excavation/grading and/or utility work to the workers who will be involved with these activities. The Utility Excavation NAPL Contingency Plan (discussed below) must also be reviewed during the pre-excavation meeting. The HASP and PPE SOP for the project shall also be reviewed and discussed.

The EP will provide oversight of soil excavation/trenching activities as described in Section 5.6. Soil excavation/trenching will occur during various phases of construction. In general, and based on the existing sampling information, all excavated materials are expected to be suitable for replacement on the Site. However, the EP will monitor the soil excavation activities for signs of significantly contaminated material which may not be suitable for reuse (as described below). The EP will also be responsible for monitoring organic vapor concentrations in the worker breathing zone within utility trenches and excavations to determine whether any increased level of health and safety protection is required.

To the extent practical, all excavation activities should be conducted in a manner to minimize double or extra handling of materials. Any stockpiles shall be kept within the Site footprint, and in a location that is not subjected to concentrated stormwater runoff. Stockpiles shall be managed as necessary to prevent the erosion and off-site migration of stockpiled materials, and in accordance with the applicable provisions of the 2011 Maryland Standards and Specifications for Soil Erosion and Sediment Control. Soil designated for replacement on-site which does not

otherwise exhibit evidence of contamination (as determined by the EP) may be managed in large stockpiles (no size restriction) as long as they remain within the erosion and sediment controls.

All utility trenches will be backfilled with bedding and backfill materials approved by the MDE for industrial use. A general utility cross section is provided as **Appendix F**. Additional preventative measures will be required if evidence of petroleum contamination is encountered, to prevent the discharge to, or migration of, petroleum product along a utility conduit. Contingency measures have been developed to ensure that utilities will be constructed in a manner that will prevent the migration of any encountered NAPL, and that excavated material will be properly managed. The Utility Excavation NAPL Contingency Plan (**Appendix G**) provides protocols to be followed if NAPL is encountered during the construction activities. Preventative measures to inhibit the spread of petroleum product will be conducted in accordance with this plan.

The EP will monitor all soil excavation and utility trenching activities for signs of potential contamination. In particular, soils will be monitored with a hand-held PID for potential VOCs and will also be visually inspected for the presence of staining, petroleum waste materials, or other indications of significant contamination. If screening of excavated materials by the EP indicates the presence of conditions of potential concern (i.e., sustained PID readings greater than 10 ppm, visual staining, unsuitable waste materials, etc.), such materials shall be segregated for additional sampling and special management.

Excavated material exhibiting evidence of significant contamination shall be placed in stockpiles (not to exceed 500 cubic yards) on polyethylene sheeting and covered with polyethylene sheeting to minimize potential exposures and erosion when not in use. Materials stockpiled due to evidence of contamination will be sampled in accordance with waste disposal requirements and transported to an appropriate permitted disposal facility. Plans for analysis of segregated soils for any use other than disposal must be submitted to the MDE for approval.

Excavated material that is visibly impacted by NAPL will be segregated and managed in accordance with the requirements specified in the Utility Excavation NAPL Contingency Plan. Excavated material with indications of possible NAPL contamination will also be containerized or placed in a stockpile (not to exceed 500 cubic yards) on polyethylene sheeting and covered with polyethylene sheeting until the material can be analyzed for TPH/Oil & Grease and PCBs (total) to characterize the material for appropriate disposal. The MDE will be notified if such materials are encountered during excavation or utility trenching activities.

5.1.3 Soil Sampling and Disposal

Excavated materials that are determined by the EP to warrant sampling and analysis because of elevated PID readings or other indications of potential contamination shall be sampled and analyzed to determine how the materials should be managed. If excavated and stockpiled, such materials should be covered with a polyethylene tarp to minimize potential exposures and erosion.

All stockpiled soil may be considered for use as fill at this Site or on other areas of the property depending on the analytical results. A sampling Work Plan including a description of the material, estimated volume, and sampling parameters will be submitted to the MDE for approval. The resulting analytical data will be submitted to the MDE to determine the suitability of the material for reuse. If the MDE determines that the materials are unsuitable for reuse, the materials will be sampled to determine if they are classified as hazardous waste.

Soil material that is determined to be a hazardous waste shall be shipped off-site in accordance with applicable regulations to an appropriate and permitted RCRA disposal facility. Soil material may be taken to an appropriate non-hazardous landfill (including Greys Landfill) for proper disposal if the concentrations of excavated sampled materials indicate that the materials are not hazardous, but still are not suitable for reuse. The quantities of all materials that require disposal, if any, will be recorded and identified in the Development Completion Report.

5.1.4 **Fill**

Processed slag aggregate sourced from the Tradepoint Atlantic property will be used as the primary fill material for this project. The placement of processed slag aggregate or materials other than approved clean fill will necessitate that the Site will be subject to surface engineering controls (i.e., capping). Soil excavated on the sub-parcel has been determined to be suitable for re-use at the Site below the surface engineering controls, unless such materials are determined by the EP/MDE to be unsuitable for use as outlined in Section 5.1.2 and Section 5.1.3.

All over-excavated utility trenches will be backfilled with bedding and backfill approved by the MDE for industrial use. Soil removed from utility trenches cannot be used as fill within the utility trenches unless such materials are approved for this use by the VCP. As with structural fill, processed slag aggregate and other materials approved for industrial use can be used as backfill in utility trenches if the area will be covered by a VCP cap. Any utility backfill which will extend into the cap (i.e., top 2 feet of backfill in landscaped areas) must meet the VCP clean fill requirements, and a geotextile marker fabric will be placed between the VCP clean fill and any underlying material. Materials placed in areas outside of the Site boundary (i.e., within the temporary construction zones outside of Sub-Parcel B6-3) must meet the VCP clean fill requirements or be otherwise approved by the MDE prior to placement. A general utility detail drawing is provided as **Appendix F**. Material imported to the Site will be screened according to MDE guidance for suitability.

5.1.5 **Dust Control**

General construction operations, including soil excavation and transport, and trenching for utilities will be performed at the Site. These activities are anticipated to be performed in areas of soil impacted with COPCs. Best management practices should be undertaken at the Sparrows Point property as a whole to prevent the generation of dust which could impact other areas of the property

outside of the immediate work zone. To limit worker exposure to contaminants borne on dust and windblown particulates, dust monitoring will be performed in the immediate work zone and at the upwind and downwind perimeter of the Site, and dust control measures will be implemented if warranted based on the monitoring results. The action level proposed for the purpose of determining the need for dust suppression techniques (e.g. watering and/or misting) during the development activities at the Site will be 3.0 mg/m³. The lowest of the site-specific dust action levels, OSHA PELs, and ACGIH TLV was selected as the proposed action level.

The EP will be responsible for the dust monitoring program. Air monitoring will be performed using Met One Instruments, Inc. E-Sampler dust monitors or equivalent real-time air monitoring devices. The EP will set-up dust monitoring equipment at the outset of ground intrusive work or other dust-generating activities, and continuous dust monitoring will be performed during this work. In addition to work area monitoring, a dust monitor will be placed at selected perimeter locations that will correspond to the upwind and downwind boundaries based on the prevailing wind direction predicted for that day. The prevailing wind direction will be assessed during the day, and the positions of the perimeter monitors will be adjusted if there is a substantial shift in the prevailing wind direction.

Once all dust-generating activities are complete (which may occur at a later stage of the project once ground intrusive work has been completed or after the Site has been capped), the dust monitoring program may be discontinued. If additional dust-generating activities commence, additional dust monitoring activities will be performed.

If sustained dust concentrations exceed the action level (3.0 mg/m³) at any of the monitoring locations as a result of conditions occurring at the Site, operations will be stopped temporarily until dust suppression can be implemented. Operations may be resumed once monitoring indicates that dust concentrations are below the action level. The background dust concentration will be utilized to evaluate whether Site activities are the source of the action level exceedance. The background dust concentration will be based on measurements over a minimum of a 1-hour period at the upwind Site boundary. The upwind data will be used to calculate a time weighted average background dust concentration. As noted above, the locations of the perimeter dust monitors may be adjusted periodically if there is a substantial shift in the prevailing wind direction.

As applicable, air monitoring will be conducted during development implementation activities to assess levels of exposure to Site workers, establish that the work zone designations are valid, and verify that respiratory protection being worn by personnel, if needed, is adequate. Concurrent with the work zone air monitoring, perimeter air monitoring will also be performed at the upwind and downwind Site boundaries to ensure contaminants are not migrating off-site. The concentration measured at the downwind perimeter shall not exceed the action level of 3.0 mg/m³, unless caused by background dust from upwind of the Site. If exceedances of the action level are identified downwind for more than five minutes, the background dust concentration shall be evaluated to

determine whether the action level exceedances are attributable to Site conditions. If on-site activities are the source of the exceedances, dust control measures and additional monitoring will be implemented. The dust suppression measures may include wetting or misting using a hose connected to a water supply or a water truck stationed at the Site.

Dust control measures will be implemented as described above to address dust generated as a result of construction activities conducted at the Site. However, based on the nature of the area and/or ongoing activities surrounding the Site, it is possible that windblown particulates may come from surrounding areas. As discussed above, the dust concentration in the upwind portion of the Site will be considered when monitoring dust levels in the work area. A pre-construction meeting will be held to discuss the potential of windblown particulates from other activities impacting the air monitoring required for this RADWP. Site contact information will be provided to address the possibility of upwind dust impacts. If sustained dust is observed above the action level (3.0 mg/m^3) and it is believed to originate from off-site (i.e., upwind) sources, this will immediately be reported to the MDE-VCP project team, as well as the MDE Air and Radiation Administration (ARA).

5.2 WATER MANAGEMENT

This plan presents the protocols for handling any groundwater or surface water that needs to be removed to facilitate construction of the proposed Sub-Parcel B6-3 development.

5.2.1 Groundwater PAL Exceedances

A total of seven shallow groundwater samples (as shown on **Figure 5**) were collected during the preceding Finishing Mills Groundwater Phase II Investigation from four temporary groundwater sample collection points (piezometers) and three permanent monitoring wells within and surrounding the Site. Aqueous PAL exceedances in shallow groundwater in the vicinity of the development LOD included both inorganics and organic compounds. The aqueous PAL exceedances obtained during the preceding Phase II Investigation are shown on **Figure GW1**.

While the concentrations of PAL exceedances are not deemed to be a significant human health hazard for future Composite Workers since there is no on-site groundwater use which could lead to direct exposures, proper water management is required during construction to prevent unacceptable discharges or risks to Construction Workers.

5.2.2 Dewatering

Dewatering may be necessary during the installation of underground utilities and within excavations/trenches. If dewatering is required, it shall be done in accordance with all local, state, and federal regulations. Water that collects in excavations/trenches due to intrusion of groundwater, stormwater, and/or dust control waters will be transported to the HCWWTP. The water will be treated and discharged in accordance with NPDES Permit No. 90-DP-0064A; I. Special Conditions; A.4; Effluent Limitations and Monitoring Requirements.

Any water that must be removed and sent to the HCWWTP will be pumped to the nearest catch basin that discharges to the TMC, or otherwise may be pumped directly to the TMC. Water in the TMC feeds into the HCWWTP where it is treated prior to release into Bear Creek. Any discharged water will be pumped through a filter bag or equivalent to remove suspended solids prior to discharge. A figure is not being provided at this time as the specific discharge location for dewatering fluids may change during development as conditions dictate. Documentation of the catch basin(s) used shall be provided in the Development Completion Report.

The EP will inspect any water that collects in the excavations/trenches. If the water exhibits indications of significant contamination (sheen, odor, discoloration, presence of product), or if the excavation/trench is within a known area of significant groundwater contamination (if groundwater is the source of the intrusive water), the water may be sampled and analyzed for some or all of the analyses listed below. The analyses run will be dependent on the suspected source of contamination and local site conditions.

The results of the analyses will be reviewed by the HCWWTP operator to determine if any wastewater treatment system adjustments are necessary. If the results of the analyses are above the threshold levels listed below, the water will be further evaluated to confirm acceptable treatment at the HCWWTP, or will be evaluated to design an appropriate pre-treatment option. Alternatively, the water may be disposed of at an appropriate off-site facility.

<u>Analysis</u>	<u>Threshold Levels</u>
• <u>Total metals by USEPA Method 6020A</u>	<u>1,000 ppm</u>
• <u>PCBs by USEPA Method 8082</u>	<u>>Non-Detect</u>
• <u>SVOCs by USEPA Method 8270C</u>	<u>1 ppm</u>
• <u>VOCs by USEPA Method 8260B</u>	<u>1 ppm</u>
• <u>Oil & Grease by USEPA Method 1664</u>	<u>200 ppm</u>

Documentation of any water testing, as well as the selected disposal option, will be reported to the MDE in the Development Completion Report. Any permits or permit modifications related to dewatering will be provided to the agencies as addenda to this RADWP.

5.3 HEALTH AND SAFETY

A property-wide HASP (**Appendix H**) has been developed and is attached to this plan to present the minimum requirements for worker health and safety protection for all development projects. All contractors working on the Site must prepare their own HASP that provides a level of protection at least as much as that provided by the attached HASP. Alternately, on-site contractors may elect to adopt the HASP provided.

General health and safety controls (level D protection) are adequate to mitigate potential risk to Construction Workers conducting ground intrusive activities for a duration of up to 25 exposure days. However, certain ground intrusive activities at the Site (utility installations for specific crews) are anticipated to exceed the allowable duration. Modified Level D PPE will be used for the entire scope of intrusive work covered by this RADWP as a protective measure to ensure that there are no unacceptable exposures for Construction Workers during project implementation. Health and safety controls outlined in the HASP and PPE SOP will mitigate any potential risk to Construction Workers from contacting impacted soil and groundwater during development. The modified Level D PPE requirements planned for this development project, including specific PPE details, planning, tracking/supervision, enforcement, and documentation, are outlined in the PPE SOP provided as **Appendix C**. The EP will be responsible for monitoring organic vapor concentrations in the worker breathing zone within the utility trenches and excavations to determine whether any increased level of health and safety protection (including engineering controls and/or PPE) is required.

Prior to commencing work, the contractor must conduct an on-site safety meeting for all personnel. All personnel must be made aware of the HASP and the PPE SOP. Detailed safety information shall be provided to personnel who may be exposed to COPCs. Workers will be responsible for following established safety procedures to prevent contact with potentially contaminated material.

5.4 INSTITUTIONAL CONTROLS (FUTURE LAND USE CONTROLS)

Long-term conditions related to future use of the Site will be placed on the RADWP approval, NFA, and COC. These conditions are anticipated to include the following:

- A restriction prohibiting the use of groundwater for any purpose at the Site and a requirement to characterize, containerize, and properly dispose of groundwater in the event of deep excavations encountering groundwater. The entire Tradepoint Atlantic property will be subject to the groundwater use restriction.
- Notice to the MDE at least 30 days prior to any future soil disturbances that are expected to breach the approved capping remedy (i.e., through the pavement cap or marker fabric in landscaped areas).
- Notice to the USEPA at least 30 days prior to any future soil disturbances that are expected to breach the approved capping remedy, only if the proposed duration of intrusive activity would exceed the allowable exposure duration determined in the SLRA and the contractor will not use the modified Level D PPE specified in the approved SOP.
- Requirement for a HASP in the event of any future excavations at the Site.
- Complete appropriate characterization and disposal of any material excavated at the Site in accordance with applicable local, state and federal requirements.
- Implementation of inspection procedures and maintenance of the containment remedies.

The responsible party will file the above deed restrictions as defined by the MDE-VCP in the NFA and COC. The Tenant will be required to sign onto the Environmental Covenant with restriction in the NFA. Tradepoint Atlantic will notify the Tenant of this requirement and will provide MDE with contact information for the Tenant prior to issuance of the NFA.

5.5 POST REMEDIATION REQUIREMENTS

Post remediation requirements will include compliance with the conditions specified in the NFA, COC, and the deed restrictions recorded for the Site. Deed restrictions will be recorded within 30 days after receipt of the final NFA. In addition, the MDE and USEPA will be provided with a written notice of any future excavations (as applicable) in accordance with the requirements given in Section 5.4. Written notice of planned excavation activities will include the proposed date(s) for the excavation, location of the excavation, health and safety protocols (as required), clean fill source (as required), and proposed characterization and disposal requirements.

Additional requirements will include inspection procedures and maintenance of the containment remedies to minimize degradation which could lead to future exposures. An Operations and Maintenance Plan (O&M Plan) will be submitted in the future for MDE approval. This O&M Plan will include long-term inspection and maintenance requirements for the capping remedies installed at the Site. The responsible party will perform cap inspections, perform maintenance of the cap, and retain inspection records, as required by the O&M Plan.

5.6 CONSTRUCTION OVERSIGHT

Construction Oversight by an EP will ensure and document that the project is built as designed and appropriate environmental and safety protocols are followed. Upon completion, the EP will certify that the project is constructed in accordance with this RADWP.

The EP will monitor all soil excavation and utility trenching activities for signs of potential contamination that may not have been previously identified. In particular, soils will be monitored with a hand-held PID for potential VOCs, and will also be visually inspected for staining, petroleum waste materials, or other indications of significant contamination. If screening of excavated materials by the EP indicates the presence of conditions of potential concern (i.e., sustained PID readings greater than 10 ppm, visual staining, unsuitable waste materials, etc.), such materials shall be segregated for additional sampling and special management (as described in Section 5.1.2; Soil Excavation and Utility Trenching). The EP will also perform routine periodic breathing zone monitoring and PPE spot checks during ground intrusive activities. The EP will also inspect any water that collects in the excavations/trenches on an as-needed basis to coordinate appropriate sampling prior to disposal (as described in Section 5.2.2; Dewatering).

Daily inspections, as necessary, will be performed during general site grading and cap construction activities to verify that appropriate fill materials are being used (as described in Section 5.1.4; Fill),

dust monitoring and control measures are being implemented as appropriate (as described in Section 5.1.5; Dust Control), the requirements of the HASP and the PPE SOP are being enforced as applicable (as described in Section 5.3; Health and Safety), and surface engineering controls are being installed with the appropriate thicknesses (shown on the RADWP attachments). Oversight by an EP will not be required during construction activities which do not have a significant environmental component, such as above-grade building construction.

Records shall be provided by the EP to document:

- Compliance with soil screening requirements
- Proper water management, including documentation of any testing and water disposal
- Observations of construction activities during site grading and cap construction
- Proper cap thickness and construction

6.0 PERMITS, NOTIFICATIONS AND CONTINGENCIES

The participant and their contractors will comply with all local, state, and federal laws and regulations by obtaining any necessary approvals and permits to conduct the activities contained herein. Any permits or permit modifications from State or local authorities will be provided as addenda to this RADWP.

A grading permit is required if the proposed grading disturbs over 5,000 square feet of surface area or over 100 cubic yards of earth. A grading permit is required for any grading activities in any watercourse, floodplain, wetland area, buffers (stream and within 100 feet of tidal water), habitat protection areas or forest buffer areas (includes forest conservation areas). Erosion and Sediment Control Plans will be submitted to, and approved by, the MDE prior to initiation of land disturbance for development.

There are no wetlands identified within the project area, so no permits are required from the MDE Water Resources Administration.

Contingency measures will include the following:

1. The MDE will be notified immediately of any previously undiscovered contamination, previously undiscovered storage tanks and other oil-related issues, and citations from regulatory entities related to health and safety practices.
2. Any significant change to the implementation schedule will be noted in the progress reports to MDE.
3. Modified Level D PPE will be used for the entire scope of intrusive work covered by this RADWP as a protective measure to ensure that there are no unacceptable exposures for Construction Workers during project implementation. The modified Level D PPE requirements which will be applied throughout this project are outlined in the PPE SOP provided as **Appendix C**. If it is not possible to implement the PPE SOP as provided, the agencies will be notified and a RADWP Addendum will be submitted to detail any appropriate mitigative measures.

7.0 IMPLEMENTATION SCHEDULE

Progress reports will be submitted to the MDE on a quarterly basis. Each quarterly progress report will include, at a minimum, a discussion of the following information regarding tasks completed during the specified quarter:

- Development Progress
- Dust Monitoring
- Water Management
- Soil Management (imported materials, screening, stockpiling)
- Soil Sampling and Disposal
- Notable Occurrences (if applicable)
- Additional Associated Work (if applicable)

The proposed implementation schedule is shown below:

<u>Task</u>	<u>Proposed Completion Date</u>
Logistics Center Grading Plan Approval	March 13, 2020
Anticipated RADWP Approval	June 26, 2020

<u>Task</u>	<u>Proposed Completion Date</u>
Groundwater Network Abandonments	June 30, 2020

<u>Task</u>	<u>Proposed Completion Date</u>
Installation of Erosion and Sediment Controls	March 2020 (start)
Slag (or Alternative Fill) Delivery and Placement	March 2020 (start)
Site Preparation/Grading – Building Pad & Parking	March 2020 (start)
Utility Installations:	June 2020 (start)
Domestic Water/Fire Loop (4 weeks)	
Sanitary (2 weeks)	
Stormwater (6 weeks)	
Pond Excavation and Grading (4 weeks)	

Construction of Building	June 2020 (start)
Installation of Pavements	July 2020 (start)
Submittal of Development Completion Report/ Notice of Completion of Remedial Actions*	December 2020
Request for NFA from the MDE	January 2021
Recordation of institutional controls in the land records office of Baltimore County	Within 30 days of receiving the approval of NFA from the MDE
Submit proof of recordation with Baltimore County	Upon receipt from Baltimore County

*Notice of Completion of Remedial Actions will be prepared by Professional Engineer registered in Maryland and submitted with the Development Completion Report to certify that the work is consistent with the requirements of this RADWP and the Site is suitable for occupancy and use.

FIGURES

- Sub-Parcel B6-3 Boundary
- Site Boundary
- Parcel Boundaries
- Private Property



Tradepoint Atlantic Area A and Area B Parcels April 17, 2020		Figure 1
 	 ARM Group LLC Engineers and Scientists	Tradepoint Atlantic
		Baltimore County, MD
		EnviroAnalytics Group
		Area A: Project 200101 Area B: Project 200102 B6-3: Project 20010206

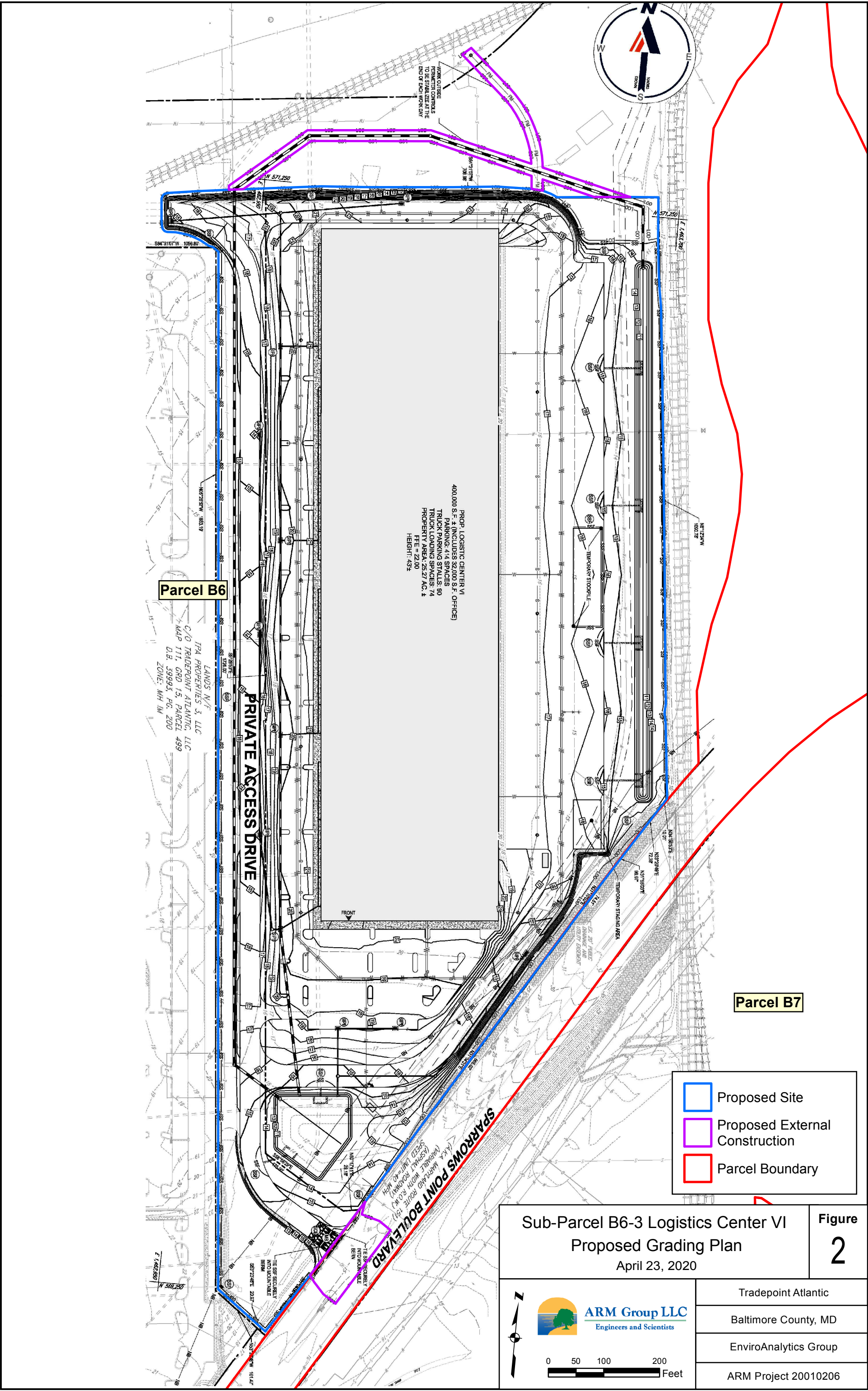

Parcel B6

Parcel B7

PROP. LOGISTIC CENTER VI
 400,000 S.F. ± (INCLUDES 32,000 S.F. OFFICE)
 PARKING: 414 SPACES
 TRUCK PARKING STALLS: 90
 TRUCK LOADING SPACES: 74
 PROPERTY AREA: 25.27 AC. ±
 FFE = 22.00
 HEIGHT: 43' ±

LANDS N/F
 TPA PROPERTIES 3, LLC
 C/O TRADEPOINT ATLANTIC, LLC
 MAP 111, GRD 15, PARCEL 499
 D.B. 33993, PG. 200
 ZONE: MH 1M



PRIVATE ACCESS DRIVE

SPARROWS POINT BOULEVARD
 (A.K.A. WYRT AND ROUTE 15)
 (SPEED LIMIT = 30 MPH)
 (SPEED WITH ROUTE 15)
 (SPEED WITH ROUTE 15)
 (SPEED WITH ROUTE 15)
 (SPEED WITH ROUTE 15)

- Proposed Site
- Proposed External Construction
- Parcel Boundary

**Sub-Parcel B6-3 Logistics Center VI
 Proposed Grading Plan**
 April 23, 2020

**Figure
 2**



ARM Group LLC
 Engineers and Scientists

0 50 100 200 Feet

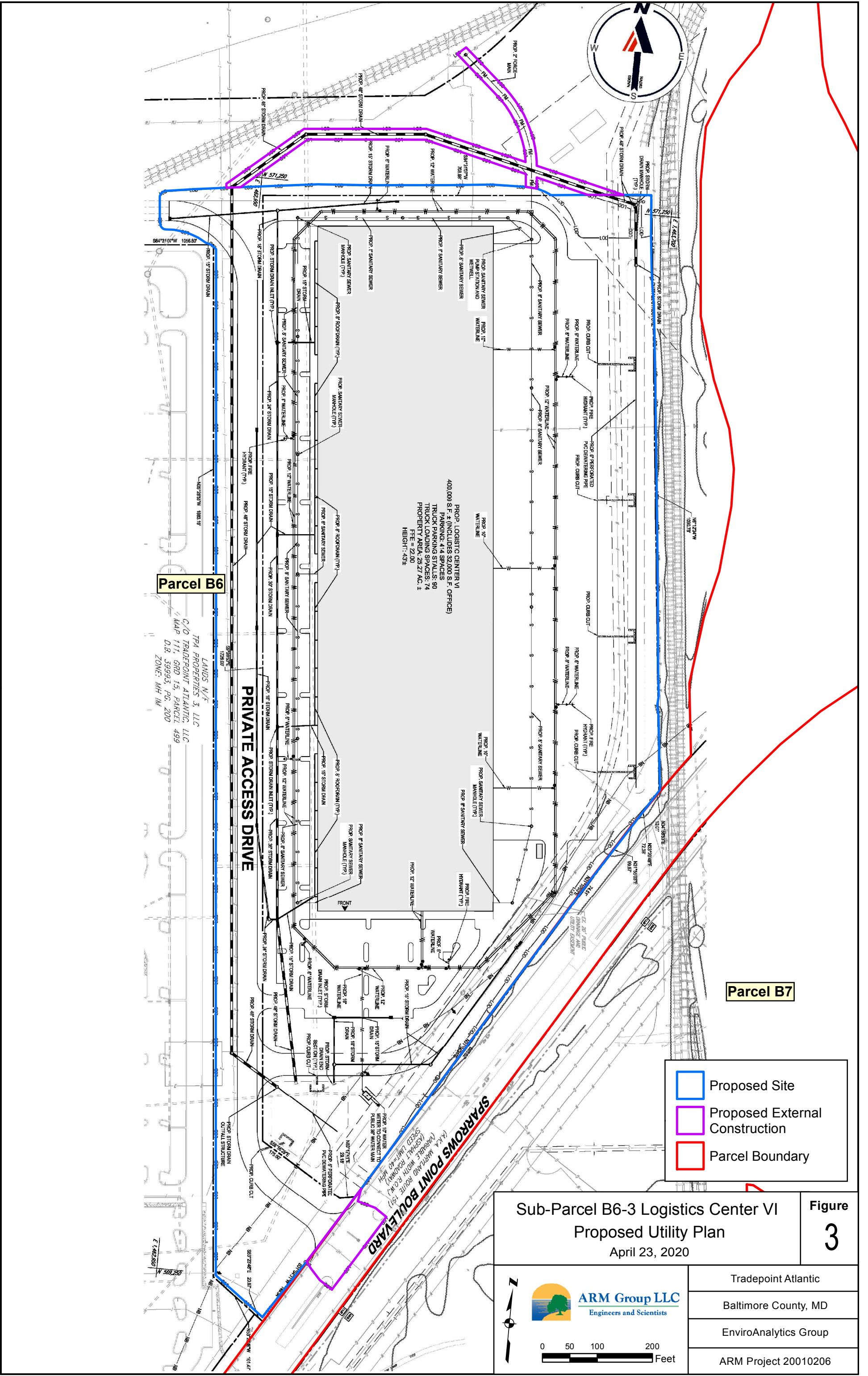
Tradepoint Atlantic
Baltimore County, MD
EnviroAnalytics Group
ARM Project 20010206



Parcel B6

Parcel B7

- Proposed Site
- Proposed External Construction
- Parcel Boundary

**Sub-Parcel B6-3 Logistics Center VI
Proposed Utility Plan**

April 23, 2020

**Figure
3**

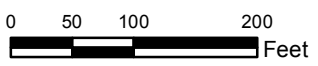

Tradepoint Atlantic
Baltimore County, MD
EnviroAnalytics Group
ARM Project 20010206

LANDS N/F
TPA PROPERTIES 3, LLC
C/O TRADEPOINT ATLANTIC, LLC
MAP 114, GRD 15, PARCEL 499
D.B. 39993, PG. 200
ZONE: MH 1M

PRIVATE ACCESS DRIVE

PROP. LOGISTICS CENTER VI
400,000 S.F. ± (INCLUDES 32,000 S.F. OFFICE)
PARKING: 414 SPACES
TRUCK PARKING STALLS: 90
PROPERTY AREA: 25.27 AC. ±
FFE = 22.00
HEIGHT: 43'±

SPARROWS POINT BOULEVARD

(A.K.A. MARYLAND ROUTE 15)
(SPEED LIMIT 70 MPH)
(SIGNAL ROUNDABOUT)
(METER TO CONNECT TO PUBLIC WATER MAIN)

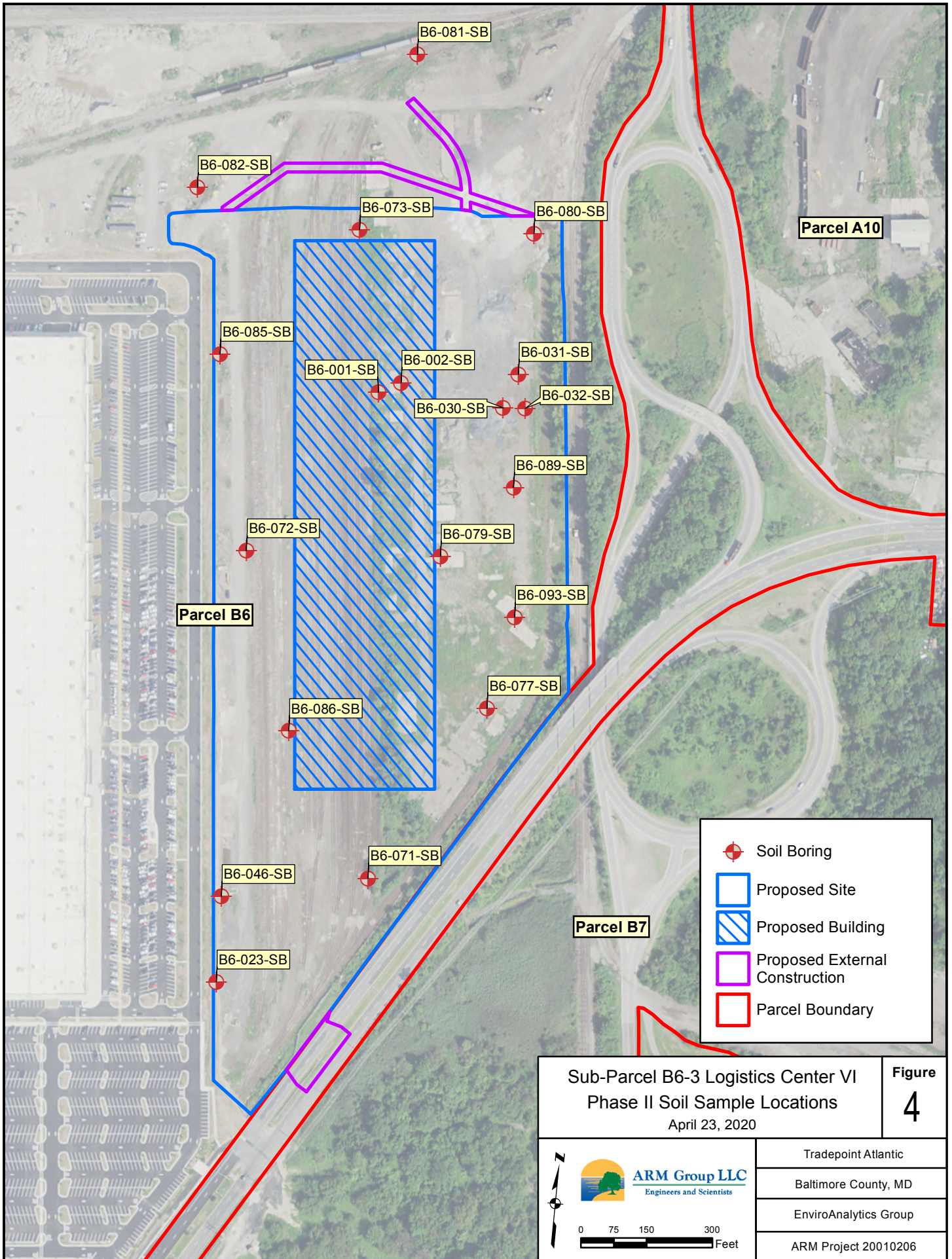

B6-081-SB

B6-082-SB

B6-073-SB

B6-080-SB

Parcel A10

B6-085-SB

B6-001-SB

B6-002-SB

B6-031-SB

B6-030-SB

B6-032-SB

Parcel B6

B6-072-SB

B6-079-SB

B6-089-SB

B6-093-SB

B6-077-SB

B6-086-SB

Parcel B7

B6-046-SB

B6-071-SB

B6-023-SB

Soil Boring

Proposed Site

Proposed Building

Proposed External Construction

Parcel Boundary

Sub-Parcel B6-3 Logistics Center VI
Phase II Soil Sample Locations
April 23, 2020

Figure
4

Tradepoint Atlantic
Baltimore County, MD
EnviroAnalytics Group
ARM Project 20010206

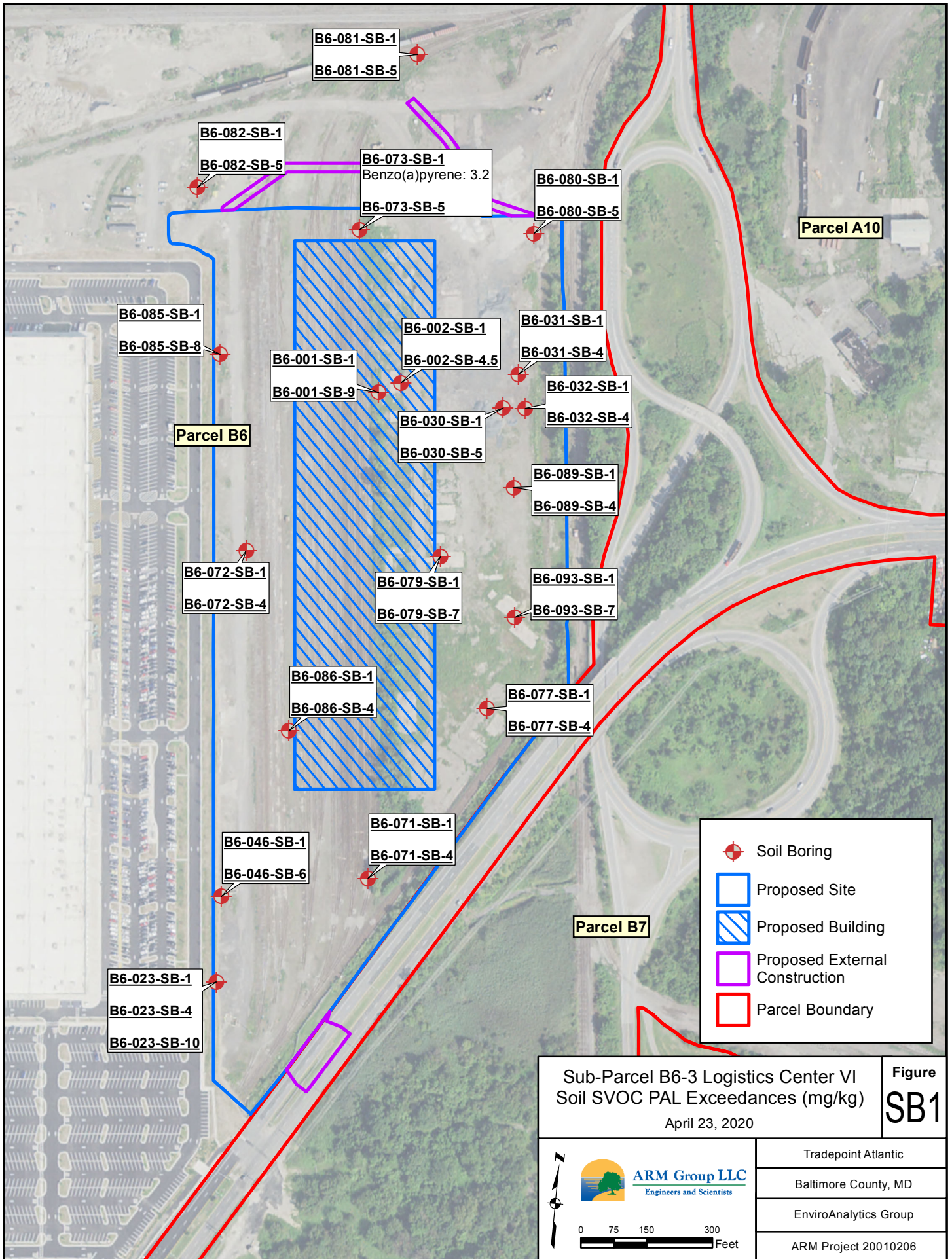

B6-081-SB-1
B6-081-SB-5

B6-082-SB-1
B6-082-SB-5

B6-073-SB-1
Benzo(a)pyrene: 3.2
B6-073-SB-5

B6-080-SB-1
B6-080-SB-5

Parcel A10

B6-085-SB-1
B6-085-SB-8

B6-001-SB-1
B6-001-SB-9

B6-002-SB-1
B6-002-SB-4.5

B6-031-SB-1
B6-031-SB-4

Parcel B6

B6-030-SB-1
B6-030-SB-5

B6-032-SB-1
B6-032-SB-4

B6-072-SB-1
B6-072-SB-4

B6-079-SB-1
B6-079-SB-7

B6-093-SB-1
B6-093-SB-7

B6-089-SB-1
B6-089-SB-4

B6-086-SB-1
B6-086-SB-4





B6-077-SB-1
B6-077-SB-4

Parcel B7

B6-046-SB-1
B6-046-SB-6

B6-071-SB-1
B6-071-SB-4

B6-023-SB-1
B6-023-SB-4
B6-023-SB-10

-  Soil Boring
-  Proposed Site
-  Proposed Building
-  Proposed External Construction
-  Parcel Boundary

Sub-Parcel B6-3 Logistics Center VI
Soil SVOC PAL Exceedances (mg/kg)
April 23, 2020

Figure
SB1



0 75 150 300 Feet

Tradepoint Atlantic
Baltimore County, MD
EnviroAnalytics Group
ARM Project 20010206

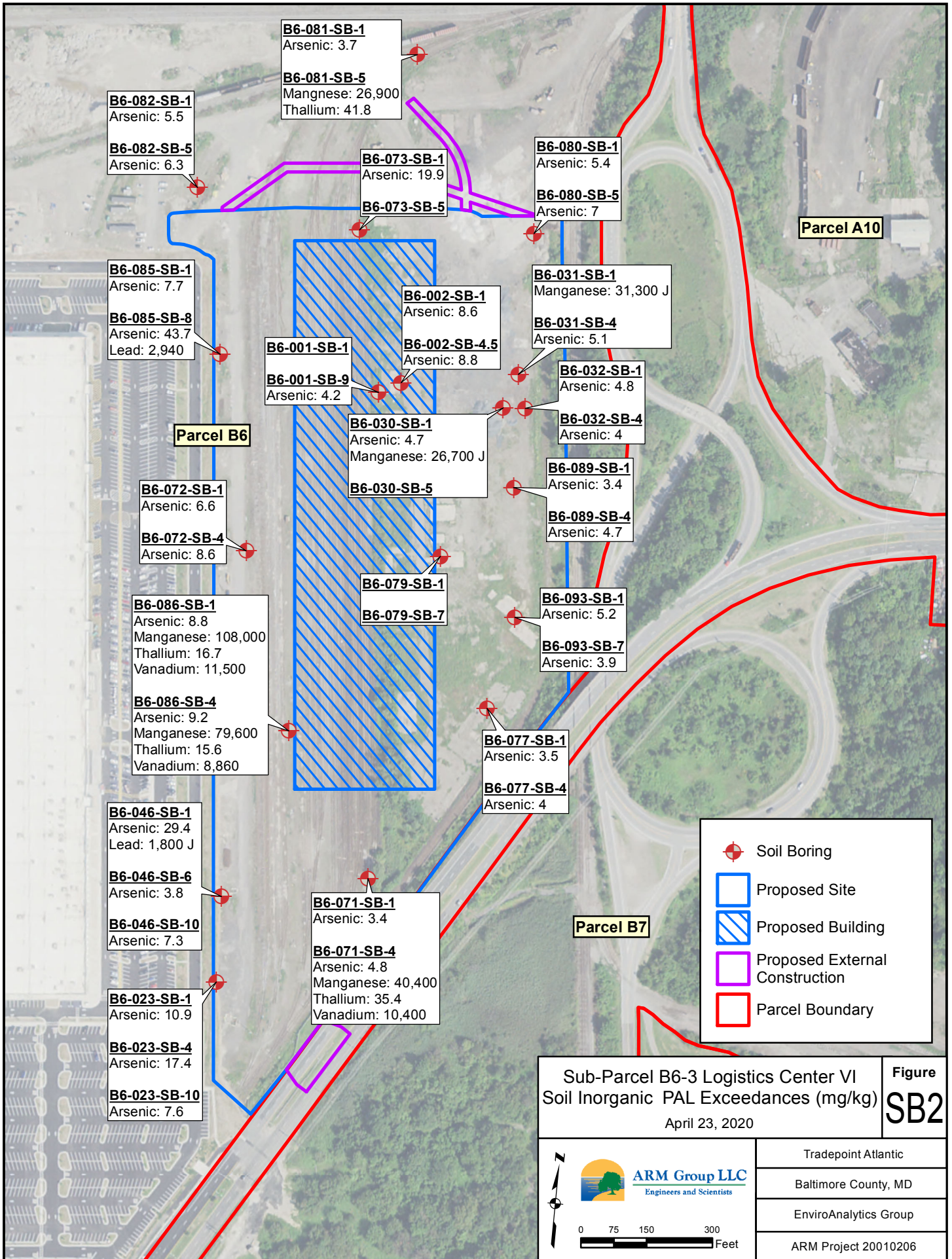

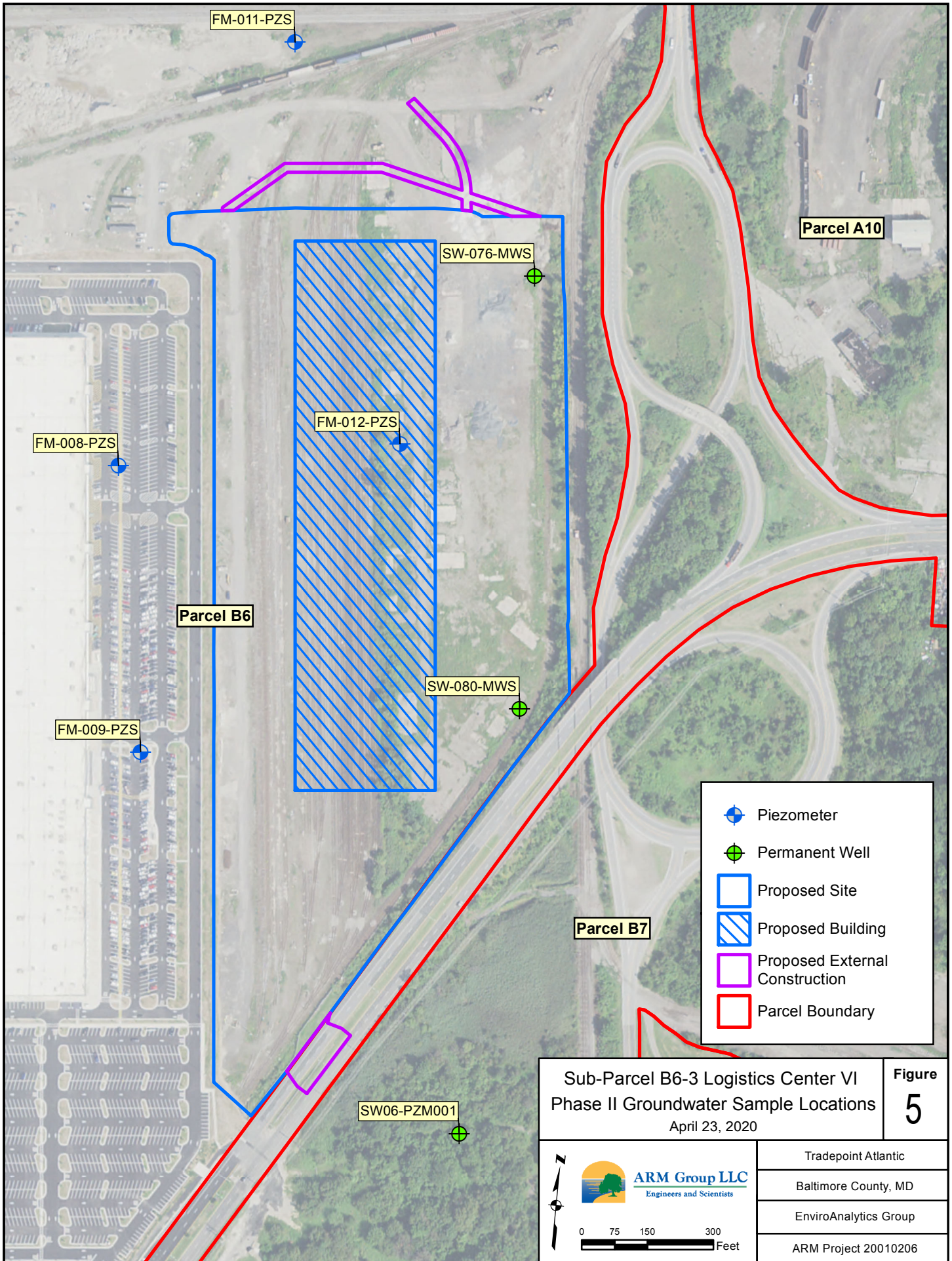

Sub-Parcel B6-3 Logistics Center VI
 Phase II Groundwater Sample Locations
 April 23, 2020

Figure
5

ARM Group LLC
 Engineers and Scientists

0 75 150 300 Feet

Tradepoint Atlantic
Baltimore County, MD
EnviroAnalytics Group
ARM Project 20010206

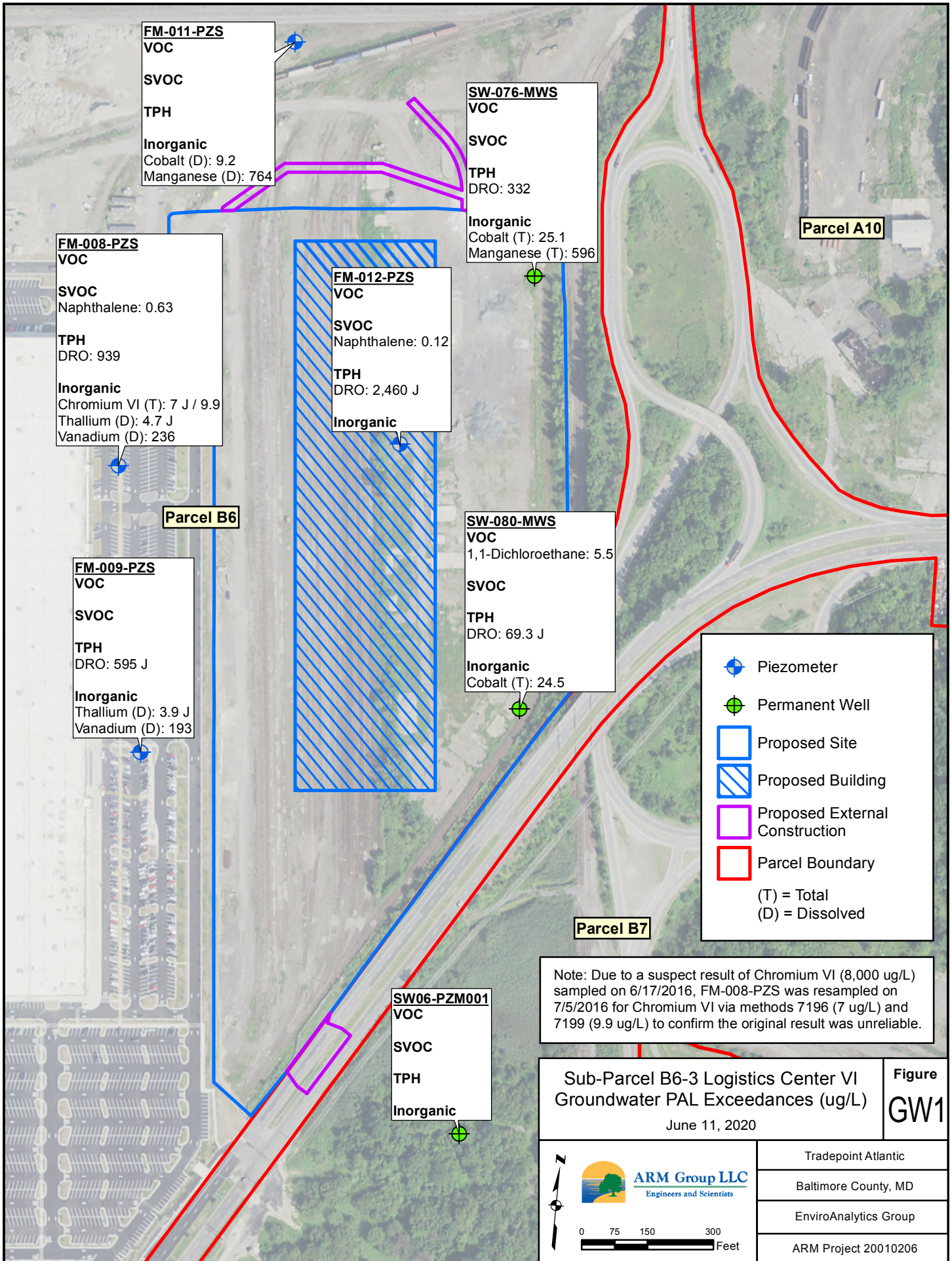

FM-011-PZS
VOC
SVOC
TPH
Inorganic
 Cobalt (D): 9.2
 Manganese (D): 764

SW-076-MWS
VOC
SVOC
TPH
 DRO: 332
Inorganic
 Cobalt (T): 25.1
 Manganese (T): 596

FM-008-PZS
VOC
SVOC
 Naphthalene: 0.63
TPH
 DRO: 939
Inorganic
 Chromium VI (T): 7 J / 9.9
 Thallium (D): 4.7 J
 Vanadium (D): 236

FM-012-PZS
VOC
SVOC
 Naphthalene: 0.12
TPH
 DRO: 2,460 J
Inorganic

SW-080-MWS
VOC
 1,1-Dichloroethane: 5.5
SVOC
TPH
 DRO: 69.3 J
Inorganic
 Cobalt (T): 24.5

FM-009-PZS
VOC
SVOC
TPH
 DRO: 595 J
Inorganic
 Thallium (D): 3.9 J
 Vanadium (D): 193

SW06-PZM001
VOC
SVOC
TPH
Inorganic

- Piezometer
- Permanent Well
- Proposed Site
- Proposed Building
- Proposed External Construction
- Parcel Boundary

(T) = Total
 (D) = Dissolved

Note: Due to a suspect result of Chromium VI (8,000 ug/L) sampled on 6/17/2016, FM-008-PZS was resampled on 7/5/2016 for Chromium VI via methods 7196 (7 ug/L) and 7199 (9.9 ug/L) to confirm the original result was unreliable.

Sub-Parcel B6-3 Logistics Center VI
Groundwater PAL Exceedances (ug/L)
 June 11, 2020
Figure GW1

ARM Group LLC
 Engineers and Scientists

0 75 150 300 Feet

Tradepoint Atlantic
Baltimore County, MD
EnviroAnalytics Group
ARM Project 20010206

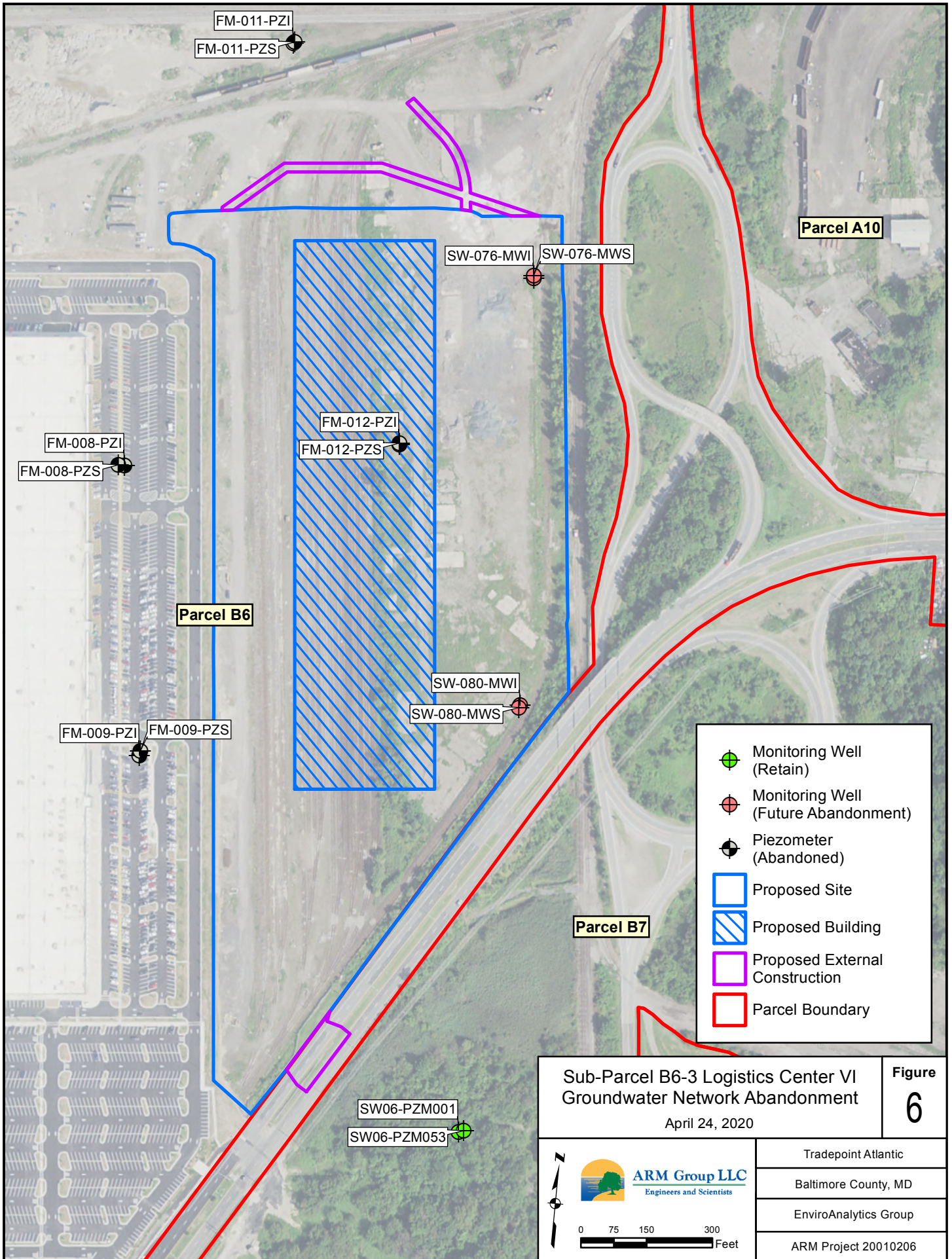

Sub-Parcel B6-3 Logistics Center VI
 Groundwater Network Abandonment
 April 24, 2020





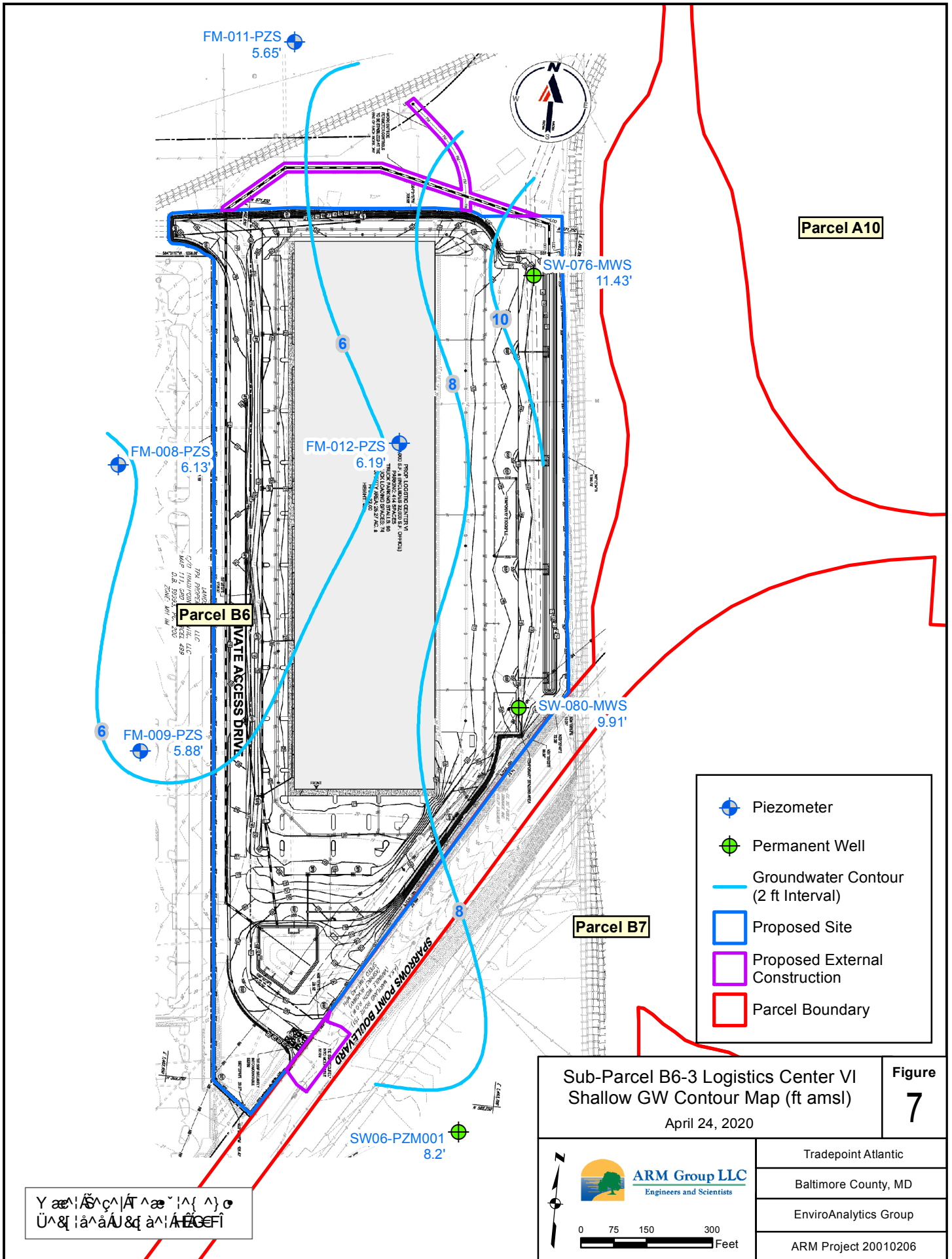

Figure
 6

 ARM Group LLC
 Engineers and Scientists

0 75 150 300
 Feet

Tradepoint Atlantic
Baltimore County, MD
EnviroAnalytics Group
ARM Project 20010206



-  Piezometer
-  Permanent Well
-  Groundwater Contour (2 ft Interval)
-  Proposed Site
-  Proposed External Construction
-  Parcel Boundary

Sub-Parcel B6-3 Logistics Center VI
 Shallow GW Contour Map (ft amsl)
 April 24, 2020

Figure
 7



ARM Group LLC
 Engineers and Scientists



Tradepoint Atlantic
Baltimore County, MD
EnviroAnalytics Group
ARM Project 20010206

Y æ: | S ç | A ^ æ ~ | ^ { ^ }
 Ü ^ & | ä ^ ä A U & | ä ^ | A E C E F I

TABLES

Table 1 - Sub-Parcel B6-3
Summary of Organics Detected in Soil

Parameter	Units	PAL	B6-001-SB-1	B6-001-SB-9	B6-002-SB-1	B6-002-SB-4.5	B6-023-SB-1	B6-023-SB-4	B6-023-SB-10	B6-030-SB-1	B6-030-SB-5	B6-031-SB-1	B6-031-SB-4	B6-032-SB-1	B6-032-SB-4
			6/15/2016	6/15/2016	6/15/2016	6/15/2016	6/14/2016	6/14/2016	6/14/2016	6/15/2016	6/15/2016	6/15/2016	6/15/2016	6/15/2016	6/15/2016
Volatile Organic Compounds															
1,2-Dichlorobenzene	mg/kg	9,300	0.0062 U	0.0057 U	0.0071 U	0.0052 U	0.0032 U	0.0064 U	N/A	0.0052 U	0.0052 U	0.0053 U	0.0049 U	0.0055 U	0.0047 U
2-Butanone (MEK)	mg/kg	190,000	0.012 U	0.011 U	0.0046 J	0.01 U	0.0064 U	0.013 U	N/A	0.01 U	0.01 U	0.008 J	0.0098 U	0.0031 J	0.0065 J
Acetone	mg/kg	670,000	0.012 U	0.011 U	0.014 U	0.01 U	0.0064 UJ	0.013 UJ	N/A	0.01 U	0.01 U	0.036	0.0098 U	0.011 U	0.018
Benzene	mg/kg	5.1	0.0062 U	0.0057 U	0.0037 J	0.0052 U	0.0032 U	0.0064 U	N/A	0.0052 U	0.0052 U	0.0053 U	0.0049 U	0.0055 U	0.0047 U
Ethylbenzene	mg/kg	25	0.0062 U	0.0057 U	0.0057 U	0.0052 U	0.0032 U	0.002 J	N/A	0.0052 U	0.0052 U	0.0053 U	0.0049 U	0.0055 U	0.0047 U
Toluene	mg/kg	47,000	0.0062 U	0.0057 U	0.0071 U	0.0052 U	0.0032 U	0.0061 J	N/A	0.0052 U	0.0052 U	0.0053 U	0.0049 U	0.0055 U	0.0047 U
Xylenes	mg/kg	2,800	0.019 U	0.017 U	0.021 U	0.016 U	0.0096 U	0.013 J	N/A	0.016 U	0.015 U	0.016 U	0.015 U	0.017 U	0.014 U
Semi-Volatile Organic Compounds[^]															
1,1-Biphenyl	mg/kg	200	0.07 U	0.083 U	0.081 U	0.082 U	0.069 U	0.044 J	N/A	0.1	0.078 U	0.072 U	0.08 U	0.022 J	0.076 U
1,2,4,5-Tetrachlorobenzene	mg/kg	350	0.07 U	0.083 U	0.081 U	0.082 U	0.069 U	0.075 U	N/A	0.071 U	0.078 U	0.072 U	0.08 U	0.07 U	0.076 U
2,4-Dimethylphenol	mg/kg	16,000	0.07 U	0.083 R	0.081 U	0.082 U	0.069 U	0.075	N/A	0.024 J	0.078 U	0.072 R	0.08 U	0.13	0.03 J
2-Chloronaphthalene	mg/kg	60,000	0.07 U	0.083 U	0.081 U	0.082 U	0.069 U	0.075 U	N/A	0.071 U	0.078 U	0.072 U	0.08 U	0.07 U	0.076 U
2-Methylnaphthalene	mg/kg	3,000	0.017	0.0084 U	0.0034 J	0.0085 U	0.07 U	0.25	N/A	0.44	0.0078 UJ	0.002 J	0.0074 J	0.17	0.0056 J
2-Methylphenol	mg/kg	41,000	0.07 U	0.083 R	0.081 U	0.082 U	0.069 U	0.075 U	N/A	0.071 U	0.078 U	0.072 R	0.08 U	0.07 U	0.076 U
3&4-Methylphenol(m&p Cresol)	mg/kg	41,000	0.14 U	0.17 R	0.16 U	0.16 U	0.14 U	0.033 J	N/A	0.14 U	0.16 U	0.14 R	0.16 U	0.039 J	0.15 U
Acenaphthene	mg/kg	45,000	0.0026 J	0.00071 J	0.0011 J	0.0085 U	0.07 U	0.073 J	N/A	0.021	0.0078 U	0.0072 U	0.033	0.011	0.08
Acenaphthylene	mg/kg	45,000	0.0062 J	0.0016 J	0.0016 J	0.0085 U	0.07 U	0.11	N/A	0.014	0.0078 U	0.0072 U	0.0081 U	0.0096	0.023
Acetophenone	mg/kg	120,000	0.07 U	0.083 U	0.081 U	0.082 U	0.069 U	0.075 U	N/A	0.071 U	0.078 U	0.072 U	0.08 U	0.07 U	0.076 U
Anthracene	mg/kg	230,000	0.017	0.002 J	0.0055 J	0.0013 J	0.07 U	0.44	N/A	0.056	0.0078 UJ	0.0011 J	0.032	0.026	0.094
Benz[a]anthracene	mg/kg	21	0.047	0.0017 J	0.023	0.0043 J	0.016 J	1.6	N/A	0.078	0.0078 U	0.0019 J	0.002 J	0.033	0.0077 U
Benzaldehyde	mg/kg	120,000	0.07 UJ	0.083 UJ	0.081 UJ	0.082 UJ	0.069 UJ	0.13 J	N/A	0.044 J	0.078 UJ	0.072 UJ	0.08 UJ	0.07 UJ	0.076 UJ
Benzo[a]pyrene	mg/kg	2.1	0.043	0.0084 U	0.018	0.0029 J	0.01 J	1.4 J	0.0082 U	0.069	0.0078 U	0.0072 U	0.0012 J	0.033	0.0077 U
Benzo[b]fluoranthene	mg/kg	21	0.12	0.0019 J	0.043	0.0075 J	0.022 J	3.4 J	0.0082 U	0.25	0.0078 U	0.0029 J	0.0038 J	0.13	0.0019 J
Benzo[g,h,i]perylene	mg/kg		0.021	0.0084 U	0.0072 J	0.0012 J	0.07 UJ	0.35 J	N/A	0.048	0.0078 U	0.0072 U	0.0081 U	0.018	0.0077 U
Benzo[k]fluoranthene	mg/kg	210	0.1	0.0016 J	0.038	0.0061 J	0.02 J	3 J	N/A	0.22	0.0078 U	0.0026 J	0.0032 J	0.12	0.0018 J
bis(2-Ethylhexyl)phthalate	mg/kg	160	0.028 J	0.083 U	0.081 U	0.082 U	0.015 J	0.075 UJ	N/A	0.056 J	0.078 U	0.072 U	0.08 U	0.032 J	0.076 U
Caprolactam	mg/kg	400,000	0.18 U	0.21 U	0.2 U	0.21 U	0.17 U	0.19 U	N/A	0.18 U	0.2 U	0.18 U	0.2 U	0.18 U	0.19 U
Carbazole	mg/kg		0.07 U	0.083 U	0.081 U	0.063 J	0.069 U	0.15	N/A	0.022 J	0.078 U	0.072 U	0.08 U	0.07 U	0.076 U
Chrysene	mg/kg	2,100	0.043	0.0011 J	0.022	0.004 J	0.0085 J	1.2	N/A	0.13	0.0078 U	0.002 J	0.005 J	0.064	0.0042 J
Dibenz[a,h]anthracene	mg/kg	2.1	0.0069 J	0.0084 U	0.0046 J	0.0085 U	0.07 UJ	0.16 J	N/A	0.015	0.0078 U	0.0072 U	0.0081 U	0.006 J	0.0077 U
Di-n-butylphthalate	mg/kg	82,000	0.05 J	0.083 U	0.081 U	0.082 U	0.069 U	0.075 U	N/A	0.071 U	0.078 U	0.072 U	0.08 U	0.07 U	0.076 U
Di-n-octylphthalate	mg/kg	8,200	0.07 U	0.083 U	0.081 U	0.082 U	0.069 UJ	0.075 UJ	N/A	0.071 UJ	0.078 UJ	0.072 U	0.08 U	0.07 UJ	0.076 U
Fluoranthene	mg/kg	30,000	0.07	0.0039 J	0.042	0.0064 J	0.013 J	2.1	N/A	0.13	0.0078 U	0.0045 J	0.013	0.055	0.006 J
Fluorene	mg/kg	30,000	0.0023 J	0.0084 U	0.0014 J	0.0085 U	0.07 U	0.13	N/A	0.045	0.0078 U	0.0072 U	0.01	0.024	0.094
Hexachloroethane	mg/kg	8	0.07 U	0.083 U	0.081 U	0.082 U	0.069 U	0.075 U	N/A	0.071 U	0.078 U	0.072 U	0.08 U	0.07 U	0.076 U
Indeno[1,2,3-c,d]pyrene	mg/kg	21	0.02	0.0084 U	0.007 J	0.0012 J	0.07 UJ	0.38 J	N/A	0.045	0.0078 U	0.0072 U	0.0081 U	0.016	0.0077 U
Naphthalene	mg/kg	8.6	0.012	0.0084 U	0.0055 B	0.0023 B	0.07 U	0.35	N/A	0.2	0.0078 U	0.0072 U	0.0062 B	0.063	0.011
N-Nitroso-di-n-propylamine	mg/kg	0.33	0.07 U	0.083 U	0.081 U	0.082 U	0.069 U	0.075 U	N/A	0.071 U	0.078 U	0.072 U	0.08 U	0.07 U	0.076 U
N-Nitrosodiphenylamine	mg/kg	470	0.07 U	0.083 U	0.081 U	0.082 U	0.069 U	0.075 U	N/A	0.055 J	0.078 U	0.072 U	0.08 U	0.026 J	0.076 U
Phenanthrene	mg/kg		0.049	0.007 J	0.025	0.0036 J	0.0092 J	1.2	N/A	0.32	0.0078 U	0.0054 J	0.04	0.12	0.23
Phenol	mg/kg	250,000	0.07 U	0.083 R	0.081 U	0.082 U	0.069 U	0.075 U	N/A	0.071 U	0.078 U	0.072 R	0.08 U	0.07 U	0.076 U
Pyrene	mg/kg	23,000	0.06	0.0028 J	0.037	0.0056 J	0.011 J	1.8	N/A	0.2	0.0078 U	0.0041 J	0.044	0.076	0.031
PCBs															
Aroclor 1242	mg/kg	0.97	0.067	N/A	0.054 U	N/A	0.05 U	N/A	N/A	0.0527 U	N/A	0.0545 U	N/A	0.0522 U	N/A
Aroclor 1254	mg/kg	0.97	0.0524 U	N/A	0.054 U	N/A	0.05 U	N/A	N/A	0.0527 U	N/A	0.0545 U	N/A	0.0522 U	N/A
Aroclor 1260	mg/kg	0.99	0.0524 U	N/A	0.054 U	N/A	0.05 U	N/A	N/A	0.0527 U	N/A	0.0545 U	N/A	0.0522 U	N/A
Aroclor 1262	mg/kg		0.0524 U	N/A	0.054 U	N/A	0.05 U	N/A	N/A	0.0527 U	N/A	0.0545 U	N/A	0.0522 U	N/A
Aroclor 1268	mg/kg		0.0524 U	N/A	0.054 U	N/A	0.05 U	N/A	N/A	0.0527 U	N/A	0.0545 U	N/A	0.0522 U	N/A
PCBs (total)	mg/kg	0.97	0.067	N/A	0.054 U	N/A	0.05 U	N/A	N/A	0.0527 U	N/A	0.0545 U	N/A	0.0522 U	N/A
TPH/Oil & Grease															
Diesel Range Organics	mg/kg	6,200	31.8 J	17.3 J	36.4 J	23.3 J	40.1 J	653 J	4.1 J	463 J	5.1 J	15.3 J	245 J	433 J	553 J
Gasoline Range Organics	mg/kg	6,200	12.5 U	11 U	14.2 U	9.5 U	6.6 U	17.3	N/A	9 U	10.5 U	10.4 U	9.7 U	8.8 U	20.3
Oil & Grease	mg/kg	6,200	N/A	N/A	N/A	N/A	N/A	N/A	N/A	N/A	N/A	N/A	N/A	N/A	N/A

Detections in bold
Values in red indicate an exceedance of the Project Action Limit (PAL)
 N/A indicates that the parameter was not analyzed for this sample
 * indicates non-validated data
 ^ PAH compounds were analyzed via SIM

U: This analyte was not detected in the sample. The numeric value represents the sample quantitation/detection limit.
 UJ: This analyte was not detected in the sample. The actual quantitation/detection limit may be higher than reported.
 J: The positive result reported for this analyte is a quantitative estimate.
 B: This analyte was not detected substantially above the level of the associated method blank or field blank.
 R: The result for this analyte is unreliable. Additional data is needed to confirm or disprove the presence of this analyte in the sample.

Table 1 - Sub-Parcel B6-3
Summary of Organics Detected in Soil

Parameter	Units	PAL	B6-046-SB-1	B6-046-SB-6	B6-071-SB-1*	B6-071-SB-4*	B6-072-SB-1*	B6-072-SB-4*	B6-073-SB-1	B6-073-SB-5	B6-077-SB-1	B6-077-SB-4	B6-079-SB-1	B6-079-SB-7	B6-080-SB-1
			6/14/2016	6/14/2016	6/17/2016	6/17/2016	6/17/2016	6/17/2016	6/16/2016	6/16/2016	6/15/2016	6/15/2016	6/15/2016	6/15/2016	6/15/2016
Volatile Organic Compounds															
1,2-Dichlorobenzene	mg/kg	9,300	0.0055 U	0.0055 U	0.0055 U	0.0054 U	0.004 U	0.0047 U	0.0062 UJ	0.0046 U	0.0059 U	0.0044 U	0.0056 U	0.0048 U	0.005 U
2-Butanone (MEK)	mg/kg	190,000	0.011 U	0.0051 J	0.011 U	0.011 U	0.008 U	0.0095 U	0.012 U	0.0093 U	0.012 U	0.0064 J	0.011 U	0.0096 U	0.01 U
Acetone	mg/kg	670,000	0.011 UJ	0.052 J	0.011 U	0.011 U	0.008 U	0.0095 U	0.012 UJ	0.0093 UJ	0.012 U	0.018	0.011 U	0.0059 J	0.01 UJ
Benzene	mg/kg	5.1	0.0055 U	0.0055 U	0.0055 U	0.0054 U	0.004 U	0.0047 U	0.0062 U	0.0046 U	0.0059 U	0.0044 U	0.0056 U	0.0048 U	0.005 U
Ethylbenzene	mg/kg	25	0.0055 U	0.0055 U	0.0055 U	0.0054 U	0.004 U	0.0047 U	0.0062 U	0.0046 U	0.0059 U	0.0044 U	0.0056 U	0.0048 U	0.005 U
Toluene	mg/kg	47,000	0.0055 U	0.0055 U	0.0055 U	0.0054 U	0.004 U	0.0047 U	0.0062 U	0.0046 U	0.0059 U	0.0015 J	0.0056 U	0.0048 U	0.005 U
Xylenes	mg/kg	2,800	0.017 U	0.016 U	0.017 U	0.016 U	0.012 U	0.014 U	0.019 U	0.014 U	0.018 U	0.013 U	0.017 U	0.014 U	0.015 U
Semi-Volatile Organic Compounds^															
1,1-Biphenyl	mg/kg	200	0.076 U	0.084 U	0.072 U	0.073 U	0.029 J	0.079 U	0.27	0.079 U	0.069 U	0.078 U	0.08 U	0.076 U	0.083 U
1,2,4,5-Tetrachlorobenzene	mg/kg	350	0.076 U	0.084 U	0.065 J	0.073 U	0.076	0.079 U	0.077 U	0.079 U	0.069 U	0.078 U	0.08 U	0.076 U	0.083 U
2,4-Dimethylphenol	mg/kg	16,000	0.076 UJ	0.084 U	0.072 U	0.073 U	0.074 U	0.079 U	0.11	0.079 U	0.069 U	0.078 U	0.08 U	0.076 U	0.083 U
2-Chloronaphthalene	mg/kg	60,000	0.076 U	0.084 U	0.072 U	0.073 U	0.21	0.079 U	0.077 U	0.079 U	0.069 U	0.078 U	0.08 U	0.076 U	0.083 U
2-Methylnaphthalene	mg/kg	3,000	0.038	0.0023 J	0.015	0.012	0.058 J	0.019	7.5	0.0079 U	0.056	0.0079 U	0.014	0.0076 U	0.0082 U
2-Methylphenol	mg/kg	41,000	0.076 UJ	0.084 U	0.072 U	0.073 U	0.074 U	0.079 U	0.11	0.079 U	0.069 U	0.078 U	0.08 U	0.076 U	0.083 U
3&4-Methylphenol(m&p Cresol)	mg/kg	41,000	0.02 J	0.17 U	0.14 U	0.14 U	0.019 J	0.026 J	0.22	0.16 U	0.14 U	0.15 U	0.16 U	0.15 U	0.17 U
Acenaphthene	mg/kg	45,000	0.0033 J	0.0017 J	0.0049 J	0.0024 J	0.074 U	0.0058 J	0.12	0.0079 U	0.0023 J	0.0079 U	0.0037 J	0.0076 U	0.0082 U
Acenaphthylene	mg/kg	45,000	0.026	0.0084 U	0.15	0.21	0.019 J	0.0062 J	0.27	0.0079 U	0.074	0.0079 U	0.019	0.0076 U	0.0082 U
Acetophenone	mg/kg	120,000	0.076 U	0.084 U	0.072 U	0.073 U	0.074 U	0.079 U	0.16	0.079 U	0.017 J	0.078 U	0.08 U	0.076 U	0.083 U
Anthracene	mg/kg	230,000	0.022	0.0084 U	0.15	0.19	0.022 J	0.04	0.9	0.0014 J	0.045 J	0.0079 U	0.013	0.001 J	0.0082 U
Benz[a]anthracene	mg/kg	21	0.036	0.0037 J	0.25	0.73	0.074 U	0.067	3.6	0.0017 J	0.23 J	0.0079 U	0.095	0.0076 U	0.0082 U
Benzaldehyde	mg/kg	120,000	0.021 J	0.084 UJ	0.022 J	0.073 U	0.041 J	0.079 U	0.45	0.079 U	0.069 UJ	0.078 UJ	0.08 UJ	0.076 UJ	0.083 U
Benzo[a]pyrene	mg/kg	2.1	0.03	0.0022 J	0.37	0.57	0.033 J	0.056	3.2	0.0079 U	0.28 J	0.0079 U	0.078	0.0076 U	0.0082 U
Benzo[b]fluoranthene	mg/kg	21	0.094	0.0061 J	1.1	1.1	0.087	0.12	5.3	0.0018 J	0.54 J	0.0079 U	0.17	0.0076 U	0.0082 U
Benzo[g,h,i]perylene	mg/kg		0.031	0.002 J	0.23	0.38	0.027 J	0.027	1.4	0.0079 U	0.21 J	0.0079 U	0.043	0.0076 U	0.0082 U
Benzo[k]fluoranthene	mg/kg	210	0.082	0.0053 J	0.93	0.45	0.075	0.1	2.1	0.0015 J	0.47 J	0.0079 U	0.15	0.0076 U	0.0082 U
bis(2-Ethylhexyl)phthalate	mg/kg	160	0.076 U	0.084 U	0.022 J	0.073 U	0.074 U	0.079 U	0.077 UJ	0.079 U	0.069 U	0.078 U	0.08 U	0.11	0.083 U
Caprolactam	mg/kg	400,000	0.19 U	0.21 U	0.18 U	0.18 U	0.19 U	0.2 U	0.19 U	0.2 U	0.17 U	0.19 U	0.2 U	0.19 U	0.21 U
Carbazole	mg/kg		0.028 J	0.084 U	0.095	0.11	0.074 U	0.035 J	0.4	0.079 U	0.069 U	0.078 U	0.08 U	0.076 U	0.083 U
Chrysene	mg/kg	2,100	0.075	0.0029 J	0.35	0.78	0.053 J	0.064	4.5	0.0011 J	0.23 J	0.0079 U	0.087	0.0076 U	0.0082 U
Dibenz[a,h]anthracene	mg/kg	2.1	0.011	0.0084 U	0.084	0.13	0.074 U	0.01	0.78	0.0079 U	0.069 J	0.0079 U	0.014	0.0076 U	0.0082 U
Di-n-butylphthalate	mg/kg	82,000	0.076 U	0.084 U	0.072 U	0.073 U	0.074 U	0.079 U	0.077 U	0.079 U	0.069 U	0.078 U	0.08 U	0.076 U	0.083 U
Di-n-octylphthalate	mg/kg	8,200	0.076 UJ	0.084 U	0.072 U	0.073 U	0.074 U	0.079 U	0.077 UJ	0.079 U	0.069 U	0.078 U	0.08 U	0.076 U	0.083 U
Fluoranthene	mg/kg	30,000	0.082	0.0059 J	0.33	1.3	0.057 J	0.15	4.6	0.0025 J	0.27 J	0.0079 U	0.18	0.0011 J	0.0082 U
Fluorene	mg/kg	30,000	0.0066 J	0.0014 J	0.0075	0.015	0.074 U	0.022	0.22	0.0079 U	0.0095	0.0079 U	0.005 J	0.0076 U	0.0082 U
Hexachloroethane	mg/kg	8	0.076 U	0.084 U	0.072 U	0.073 U	0.074 U	0.079 U	0.057 J	0.079 U	0.069 U	0.078 U	0.08 U	0.076 U	0.083 U
Indeno[1,2,3-c,d]pyrene	mg/kg	21	0.022	0.0016 J	0.22	0.38	0.022 J	0.024	1.4	0.0079 U	0.19 J	0.0079 U	0.042	0.0076 U	0.0082 U
Naphthalene	mg/kg	8.6	0.1	0.0047 B	0.037	0.037	0.057 J	0.047	5.1	0.0079 U	0.094	0.0079 U	0.011	0.0076 U	0.0082 U
N-Nitroso-di-n-propylamine	mg/kg	0.33	0.076 U	0.084 U	0.072 U	0.073 U	0.074 U	0.079 U	0.077 U	0.079 U	0.069 U	0.078 U	0.08 U	0.076 U	0.083 U
N-Nitrosodiphenylamine	mg/kg	470	0.076 U	0.084 U	0.072 U	0.073 U	0.074 U	0.079 U	0.077 U	0.079 U	0.069 U	0.078 U	0.08 U	0.076 U	0.083 U
Phenanthrene	mg/kg		0.16	0.0053 J	0.082	0.2	0.084	0.13	6.5	0.0034 J	0.09	0.0079 U	0.052	0.0045 J	0.0082 U
Phenol	mg/kg	250,000	0.076 UJ	0.084 U	0.072 U	0.018 J	0.074 U	0.079 U	0.11	0.079 U	0.069 U	0.078 U	0.08 U	0.076 U	0.083 U
Pyrene	mg/kg	23,000	0.069	0.0048 J	0.35	1.8	0.049 J	0.12	3.7	0.0019 J	0.22 J	0.0079 U	0.16	0.001 J	0.0082 U
PCBs															
Aroclor 1242	mg/kg	0.97	0.0568 U	N/A	0.0569 U	N/A	0.0534 U	N/A	0.0539 U	N/A	0.0565 U	N/A	0.0555 U	N/A	0.0577 U
Aroclor 1254	mg/kg	0.97	0.0568 U	N/A	0.0569 U	N/A	0.0534 U	N/A	0.0539 U	N/A	0.0565 U	N/A	0.0555 U	N/A	0.0577 U
Aroclor 1260	mg/kg	0.99	0.0568 U	N/A	0.537	N/A	0.0534 U	N/A	0.0539 U	N/A	0.0565 U	N/A	0.0555 U	N/A	0.0577 U
Aroclor 1262	mg/kg		0.0568 U	N/A	0.0569 U	N/A	0.0689	N/A	0.134	N/A	0.0565 U	N/A	0.0555 U	N/A	0.0577 U
Aroclor 1268	mg/kg		0.0568 U	N/A	0.0569 U	N/A	0.0534 U	N/A	0.0539 U	N/A	0.0565 U	N/A	0.0555 U	N/A	0.0577 U
PCBs (total)	mg/kg	0.97	0.0568 U	N/A	0.537	N/A	0.0689	N/A	0.134	N/A	0.0565 U	N/A	0.0555 U	N/A	0.0577 U
TPH/Oil & Grease															
Diesel Range Organics	mg/kg	6,200	64.8 J	10.6 J	40	43.8	22.2	28.2	270 J	8 UJ	60 J	4.9 J	41.3 J	46.7 J	8.2 UJ
Gasoline Range Organics	mg/kg	6,200	11.1 U	10.3 U	10.6 U	12 U	9.2 U	11.2 U	17.1	10.8 U	11.1 U	9 U	11.4 U	10.7 U	10.2 U
Oil & Grease	mg/kg	6,200	N/A	N/A	N/A	N/A	N/A	N/A	N/A	N/A	N/A	N/A	N/A	N/A	N/A

Detections in bold

Values in red indicate an exceedance of the Project Action Limit (PAL)

N/A indicates that the parameter was not analyzed for this sample

* indicates non-validated data

^ PAH compounds were analyzed via SIM

U: This analyte was not detected in the sample. The numeric value represents the sample quantitation/detection limit.

UJ: This analyte was not detected in the sample. The actual quantitation/detection limit may be higher than reported.

J: The positive result reported for this analyte is a quantitative estimate.

B: This analyte was not detected substantially above the level of the associated method blank or field blank.

R: The result for this analyte is unreliable. Additional data is needed to confirm or disprove the presence of this analyte in the sample.

Table 1 - Sub-Parcel B6-3
Summary of Organics Detected in Soil

Parameter	Units	PAL	B6-080-SB-5	B6-081-SB-1	B6-081-SB-5	B6-082-SB-1*	B6-082-SB-5*	B6-085-SB-1*	B6-085-SB-8*	B6-086-SB-1*	B6-086-SB-4*	B6-089-SB-1	B6-089-SB-4	B6-093-SB-1*	B6-093-SB-7*
			6/16/2016	6/16/2016	6/16/2016	6/17/2016	6/17/2016	6/17/2016	6/17/2016	6/17/2016	6/17/2016	6/17/2016	6/17/2016	9/19/2016	9/19/2016
Volatile Organic Compounds															
1,2-Dichlorobenzene	mg/kg	9,300	0.0049 U	0.0063 U	0.0067 UJ	0.0069 U	0.005 U	0.0058 U	0.0058 U	0.0055 U	0.011 U	0.0052 U	0.00085 J	0.0044 U	0.0049 U
2-Butanone (MEK)	mg/kg	190,000	0.0099 U	0.013 U	0.013 UJ	0.014 U	0.01 U	0.012 U	0.012 U	0.011 U	0.022 U	0.01 U	0.0073 J	0.0089 U	0.0023 J
Acetone	mg/kg	670,000	0.0099 UJ	0.013 UJ	0.013 UJ	0.014 U	0.01 U	0.012 U	0.012 U	0.011 U	0.022 U	0.01 U	0.055 J	0.0089 U	0.014 B
Benzene	mg/kg	5.1	0.0049 U	0.0063 U	0.0067 UJ	0.0069 U	0.005 U	0.0058 U	0.0058 U	0.0055 U	0.011 U	0.0052 U	0.005 U	0.0044 U	0.0049 U
Ethylbenzene	mg/kg	25	0.0049 U	0.0063 U	0.0067 UJ	0.0069 U	0.005 U	0.0058 U	0.0058 U	0.0055 U	0.011 U	0.0052 U	0.005 U	0.0044 U	0.0049 U
Toluene	mg/kg	47,000	0.0049 U	0.0063 U	0.0067 UJ	0.0069 U	0.005 U	0.0058 U	0.0058 U	0.0055 U	0.011 U	0.0052 U	0.005 U	0.0044 U	0.0049 U
Xylenes	mg/kg	2,800	0.015 U	0.019 U	0.02 UJ	0.021 U	0.015 U	0.017 U	0.017 U	0.017 U	0.033 U	0.016 U	0.015 U	0.0049 J	0.015 U
Semi-Volatile Organic Compounds^															
1,1-Biphenyl	mg/kg	200	0.078 U	0.075 U	0.081 U	0.075 U	0.081 U	0.075 U	0.03 J	0.068 U	0.073 U	0.028 J	0.15	0.073 U	0.076 U
1,2,4,5-Tetrachlorobenzene	mg/kg	350	0.078 U	0.075 U	0.081 U	0.075 U	0.081 U	0.075 U	0.078 U	0.068 U	0.062 J	0.073 U	0.084 U	0.073 U	0.076 U
2,4-Dimethylphenol	mg/kg	16,000	0.078 U	0.075 U	0.081 U	0.075 U	0.081 U	0.075 U	0.078 U	0.068 U	0.073 U	0.016 J	0.084 U	0.073 U	0.076 U
2-Chloronaphthalene	mg/kg	60,000	0.078 U	0.075 U	0.081 U	0.075 U	0.081 U	0.075 U	0.078 U	0.068 U	0.073 U	0.073 U	0.084 U	0.073 U	0.076 U
2-Methylnaphthalene	mg/kg	3,000	0.0079 U	0.013	0.012	0.013	0.0082 U	0.1	0.13	0.0033 J	0.022	0.07	0.64	0.13	0.0075 J
2-Methylphenol	mg/kg	41,000	0.078 U	0.075 U	0.081 U	0.075 U	0.081 U	0.075 U	0.078 U	0.068 U	0.073 U	0.073 U	0.084 U	0.073 U	0.076 U
3&4-Methylphenol(m&p Cresol)	mg/kg	41,000	0.16 U	0.15 U	0.16 U	0.15 U	0.16 U	0.15 U	0.021 J	0.14 U	0.15 U	0.15 U	0.17 U	0.15 U	0.15 U
Acenaphthene	mg/kg	45,000	0.0079 U	0.0026 J	0.0017 J	0.0018 J	0.0082 U	0.004 J	0.0073 J	0.00066 J	0.00081 J	0.0038 J	0.12	0.0084 J	0.0045 J
Acenaphthylene	mg/kg	45,000	0.0079 U	0.0074	0.0087	0.0066 J	0.0082 U	0.018	0.0071 J	0.0039 J	0.022	0.015	0.037	0.018 J	0.0012 J
Acetophenone	mg/kg	120,000	0.078 U	0.075 U	0.081 U	0.075 U	0.081 U	0.075 U	0.078 U	0.068 U	0.073 U	0.022 J	0.084 U	0.022 J	0.076 U
Anthracene	mg/kg	230,000	0.0079 U	0.0092	0.011	0.01	0.0015 J	0.033	0.035	0.0044 J	0.012	0.022	0.22	0.014 J	0.0054 J
Benz[a]anthracene	mg/kg	21	0.0079 U	0.036	0.022	0.041	0.0058 J	0.13	0.066	0.0073	0.0081	0.059	0.0074 J	0.083	0.0076 U
Benzaldehyde	mg/kg	120,000	0.078 U	0.075 U	0.081 U	0.075 U	0.081 U	0.019 J	0.056 J	0.068 U	0.073 U	0.05 J	0.084 UJ	0.022 J	0.076 U
Benzo[a]pyrene	mg/kg	2.1	0.0079 U	0.041	0.03	0.036	0.0044 J	0.14	0.054	0.0077	0.0098	0.051	0.0077 J	0.067 J	0.0076 U
Benzo[b]fluoranthene	mg/kg	21	0.0079 U	0.085	0.069	0.093	0.0096	0.3	0.16	0.032	0.026	0.21	0.025	0.15	0.0076 U
Benzo[g,h,i]perylene	mg/kg		0.0079 U	0.035	0.033	0.027	0.0023 J	0.074	0.036	0.0094	0.0085	0.025	0.0035 J	0.036 J	0.0076 U
Benzo[k]fluoranthene	mg/kg	210	0.0079 U	0.085	0.025	0.081	0.0083	0.26	0.14	0.028	0.023	0.18	0.021	0.11	0.0076 U
bis(2-Ethylhexyl)phthalate	mg/kg	160	0.078 U	0.075 U	0.081 U	0.075 U	0.081 U	0.075 U	0.078 U	0.068 U	0.073 U	0.077 J	0.029 J	0.039 J	0.076 U
Caprolactam	mg/kg	400,000	0.2 U	0.19 U	0.2 U	0.19 U	0.2 U	0.19 U	0.19 U	0.17 U	0.18 U	0.18 U	0.21 U	0.021 J	0.19 U
Carbazole	mg/kg		0.078 U	0.075 U	0.081 U	0.075 U	0.081 U	0.075 U	0.078 U	0.068 U	0.073 U	0.073 U	0.084 U	0.073 U	0.076 U
Chrysene	mg/kg	2,100	0.0079 U	0.043	0.037	0.04	0.0057 J	0.15	0.15	0.014	0.017	0.099	0.014	0.073 J	0.0076 U
Dibenz[a,h]anthracene	mg/kg	2.1	0.0079 U	0.011	0.0097	0.009	0.0016 J	0.027	0.017	0.0027 J	0.0019 J	0.0076	0.0084 U	0.012 J	0.0076 U
Di-n-butylphthalate	mg/kg	82,000	0.078 U	0.075 U	0.081 U	0.075 U	0.081 U	0.075 U	0.078 U	0.068 U	0.073 U	0.073 U	0.084 U	0.037 J	0.076 U
Di-n-octylphthalate	mg/kg	8,200	0.078 U	0.075 U	0.081 U	0.075 U	0.081 U	0.075 U	0.078 U	0.068 U	0.073 U	0.073 UJ	0.084 UJ	0.04 J	0.076 U
Fluoranthene	mg/kg	30,000	0.0079 U	0.062	0.031	0.058	0.0069 J	0.21	0.12	0.013	0.023	0.15	0.031	0.1	0.00065 J
Fluorene	mg/kg	30,000	0.0079 U	0.0019 J	0.0027 J	0.0018 J	0.0082 U	0.0082	0.017	0.0006 J	0.0022 J	0.0091	0.31	0.0071 J	0.0073 J
Hexachloroethane	mg/kg	8	0.078 U	0.075 U	0.081 U	0.075 U	0.081 U	0.075 U	0.078 U	0.068 U	0.073 U	0.073 U	0.084 U	0.073 U	0.076 U
Indeno[1,2,3-c,d]pyrene	mg/kg	21	0.0079 U	0.03	0.028	0.022	0.0021 J	0.068	0.026	0.0074	0.0056 J	0.028	0.0033 J	0.033 J	0.0076 U
Naphthalene	mg/kg	8.6	0.0031 B	0.014	0.012	0.0064 J	0.0082 U	0.069	0.067	0.0029 J	0.053	0.077	0.087	0.11	0.0031 J
N-Nitroso-di-n-propylamine	mg/kg	0.33	0.078 U	0.075 U	0.081 U	0.075 U	0.081 U	0.075 U	0.078 U	0.068 U	0.073 U	0.073 U	0.084 U	0.056 J	0.076 U
N-Nitrosodiphenylamine	mg/kg	470	0.078 U	0.075 U	0.081 U	0.075 U	0.081 U	0.075 U	0.029 J	0.068 U	0.073 U	0.027 J	0.084 U	0.073 U	0.076 U
Phenanthrene	mg/kg		0.00067 J	0.032	0.027	0.035	0.0037 J	0.16	0.21	0.0079	0.064	0.093	0.82	0.095	0.022
Phenol	mg/kg	250,000	0.078 U	0.075 U	0.081 U	0.075 U	0.081 U	0.075 U	0.021 J	0.068 U	0.073 U	0.073 U	0.084 U	0.073 U	0.076 U
Pyrene	mg/kg	23,000	0.0079 U	0.053	0.029	0.051	0.0064 J	0.18	0.099	0.013	0.02	0.14	0.13	0.089	0.0015 J
PCBs															
Aroclor 1242	mg/kg	0.97	N/A	0.055 U	N/A	0.054 U	N/A	0.0546 U	N/A	0.0536 U	N/A	0.0551 U	N/A	0.0607 U	N/A
Aroclor 1254	mg/kg	0.97	N/A	0.055 U	N/A	0.054 U	N/A	0.0546 U	N/A	0.0536 U	N/A	0.0551 U	N/A	0.434	N/A
Aroclor 1260	mg/kg	0.99	N/A	0.055 U	N/A	0.054 U	N/A	0.0546 U	N/A	0.0536 U	N/A	0.0551 U	N/A	0.439	N/A
Aroclor 1262	mg/kg		N/A	0.055 U	N/A	0.054 U	N/A	0.0546 U	N/A	0.0536 U	N/A	0.0551 U	N/A	0.0607 U	N/A
Aroclor 1268	mg/kg		N/A	0.055 U	N/A	0.054 U	N/A	0.0546 U	N/A	0.072	N/A	0.0551 U	N/A	0.0607 U	N/A
PCBs (total)	mg/kg	0.97	N/A	0.055 U	N/A	0.054 U	N/A	0.0546 U	N/A	0.072	N/A	0.0551 U	N/A	0.873	N/A
TPH/Oil & Grease															
Diesel Range Organics	mg/kg	6,200	7.9 UJ	10.8 J	23.8 J	13.2	3.8 J	31.6	50.9	4.3 J	35.7	560	259	75.6	6 B
Gasoline Range Organics	mg/kg	6,200	9 U	16 U	13.7 U	10.3 U	12 U	9.1 U	10 U	13 U	23.7 U	11.2 U	18.7	12.2 U	9.9 U
Oil & Grease	mg/kg	6,200	N/A	N/A	N/A	N/A	N/A	N/A	N/A	N/A	N/A	2,820	725	602	318

Detections in bold
Values in red indicate an exceedance of the Project Action Limit (PAL)
 N/A indicates that the parameter was not analyzed for this sample
 * indicates non-validated data
 ^ PAH compounds were analyzed via SIM

U: This analyte was not detected in the sample. The numeric value represents the sample quantitation/detection limit.
 UJ: This analyte was not detected in the sample. The actual quantitation/detection limit may be higher than reported.
 J: The positive result reported for this analyte is a quantitative estimate.
 B: This analyte was not detected substantially above the level of the associated method blank or field blank.
 R: The result for this analyte is unreliable. Additional data is needed to confirm or disprove the presence of this analyte in the sample.

**Table 2 - Sub-Parcel B6-3
Summary of Inorganics Detected in Soil**

Parameter	Units	PAL	B6-001-SB-1	B6-001-SB-9	B6-002-SB-1	B6-002-SB-4.5	B6-023-SB-1	B6-023-SB-4	B6-023-SB-10
			6/15/2016	6/15/2016	6/15/2016	6/15/2016	6/14/2016	6/14/2016	6/14/2016
Metals									
Aluminum	mg/kg	1,100,000	25,900	12,700	21,700	14,800	3,790	20,400	N/A
Arsenic	mg/kg	3	1.9 U	4.2	8.6	8.8	10.9	17.4	7.6
Barium	mg/kg	220,000	233 J	52 J	252 J	59.4 J	45.3	366	N/A
Beryllium	mg/kg	2,300	3.7	0.33 J	2	0.96	0.72 J	1.5	N/A
Cadmium	mg/kg	980	0.58 B	0.2 B	0.87 B	0.28 B	0.27 B	3.1	N/A
Chromium	mg/kg	120,000	842	20.7	37.7	28.6	112	145	N/A
Chromium VI	mg/kg	6.3	0.33 B	0.4 B	0.34 B	0.39 B	0.34 B	0.68 B	N/A
Cobalt	mg/kg	350	3.9 U	3.3 J	13.3	8.8	8.4	13	N/A
Copper	mg/kg	47,000	12.5	7.4	149	24	68.4 J	199 J	N/A
Iron	mg/kg	820,000	100,000	19,800	24,900	23,800	232,000	85,100	N/A
Lead	mg/kg	800	19.6	6.7	50.2	24.2	2.5 J	498 J	N/A
Manganese	mg/kg	26,000	17,800 J	176 J	3,480 J	203 J	1,290	5,550	N/A
Mercury	mg/kg	350	0.1 U	0.021 J	0.09 J	0.036 J	0.01 J-	0.075 J-	N/A
Nickel	mg/kg	22,000	11.1	8.5 J	37.8	23.9	138	33	N/A
Selenium	mg/kg	5,800	3.1 U	3.8 U	3.7 U	3.8 U	3.1 U	3.4 U	N/A
Silver	mg/kg	5,800	2.3 U	2.9 U	2.8 U	2.8 U	2.6	2.5 U	N/A
Thallium	mg/kg	12	7.8 U	9.6 U	9.3 U	9.5 U	7.8 UJ	7.4 J	N/A
Vanadium	mg/kg	5,800	466 J	28.6 J	61.2 J	48.1 J	7.2	554	N/A
Zinc	mg/kg	350,000	81.7	43.2	323	85.3	24.6 J	1,180 J	N/A
Other									
Cyanide	mg/kg	150	0.8 J+	0.76 U	0.19 J+	0.73 U	0.3 J-	2 J-	N/A

Detections in bold

Values in red indicate an exceedance of the Project Action Limit (PAL)

N/A indicates that the parameter was not analyzed for this sample

* indicates non-validated data

U: This analyte was not detected in the sample. The numeric value represents the ample quantitation/detection limit.

UJ: This analyte was not detected in the sample. The actual quantitation/detection limit may be higher than reported.

J: The positive result reported for this analyte is a quantitative estimate.

J+: The positive result reported for this analyte is a quantitative estimate but may be biased high.

J-: The positive result reported for this analyte is a quantitative estimate but may be biased low.

B: This analyte was not detected substantially above the level of the associated method blank or field blank.

**Table 2 - Sub-Parcel B6-3
Summary of Inorganics Detected in Soil**

Parameter	Units	PAL	B6-030-SB-1	B6-030-SB-5	B6-031-SB-1	B6-031-SB-4	B6-032-SB-1	B6-032-SB-4	B6-046-SB-1
			6/15/2016	6/15/2016	6/15/2016	6/15/2016	6/15/2016	6/15/2016	6/15/2016
Metals									
Aluminum	mg/kg	1,100,000	17,700	13,700	18,400	17,900	20,400	11,200	18,500
Arsenic	mg/kg	3	4.7	2.5	2.2 U	5.1	4.8	4	29.4
Barium	mg/kg	220,000	203 J	36.7 J	66.4 J	45.1 J	293 J	58.3 J	357
Beryllium	mg/kg	2,300	1.8	0.46 J	0.88 U	0.51 J	2.6	0.86 J	2.1
Cadmium	mg/kg	980	1.9	1.5 U	0.58 B	0.2 B	3.1	1.3 U	11.1
Chromium	mg/kg	120,000	808	16.7	1,220	29.3	435	12.5	1,050
Chromium VI	mg/kg	6.3	0.46 B	0.52 B	3.9 J-	0.34 B	0.5 B	0.32 B	0.41 B
Cobalt	mg/kg	350	3.4 J	3.8 J	4.4 U	4.8	7.8	9.6	128
Copper	mg/kg	47,000	47.5	4.5 J	29.8	10.2	57.3	5.2	669 J
Iron	mg/kg	820,000	104,000	13,600	187,000	24,300	79,800	11,100	221,000
Lead	mg/kg	800	74.6	9.8	2.2 UJ	10.2	102	9.1	1,800 J
Manganese	mg/kg	26,000	26,700 J	80.4 J	31,300 J	190 J	14,800 J	151 J	8,330
Mercury	mg/kg	350	0.027 J	0.11 U	0.1 U	0.11 U	0.011 J	0.032 J	0.065 J
Nickel	mg/kg	22,000	25.2	9 J	16.8	12	24.6	12.6	1,010
Selenium	mg/kg	5,800	3.3 U	3.9 U	3.5 U	3.2 U	3.2 U	3.5 U	3.6 U
Silver	mg/kg	5,800	1.4 J	2.9 U	0.74 J	2.4 U	2.4 U	2.7 U	4.7
Thallium	mg/kg	12	4.5 J	9.7 U	8.8 U	8 U	7.9 U	8.9 U	5.7 J
Vanadium	mg/kg	5,800	4,190 J	23.4 J	723 J	33.7 J	1,710 J	19.9 J	195
Zinc	mg/kg	350,000	199	26.2	125	36.1	306	33.3	6,260 J
Other									
Cyanide	mg/kg	150	0.66 J+	0.71 U	0.06 J+	0.73 U	0.4 J+	0.086 J+	0.65 J-

Detections in bold

Values in red indicate an exceedance of the Project Action Limit (PAL)

N/A indicates that the parameter was not analyzed for this sample

* indicates non-validated data

U: This analyte was not detected in the sample. The numeric value represents the ample quantitation/detection limit.

UJ: This analyte was not detected in the sample. The actual quantitation/detection limit may be higher than reported.

J: The positive result reported for this analyte is a quantitative estimate.

J+: The positive result reported for this analyte is a quantitative estimate but may be biased high.

J-: The positive result reported for this analyte is a quantitative estimate but may be biased low.

B: This analyte was not detected substantially above the level of the associated method blank or field blank.

**Table 2 - Sub-Parcel B6-3
Summary of Inorganics Detected in Soil**

Parameter	Units	PAL	B6-046-SB-6	B6-046-SB-10	B6-071-SB-1*	B6-071-SB-4*	B6-072-SB-1*	B6-072-SB-4*	B6-073-SB-1
			6/14/2016	6/14/2016	6/17/2016	6/17/2016	6/17/2016	6/17/2016	6/16/2016
Metals									
Aluminum	mg/kg	1,100,000	23,600	N/A	36,900	16,100	13,500	13,800	10,500
Arsenic	mg/kg	3	3.8	7.3	3.4	4.8	6.6	8.6	19.9
Barium	mg/kg	220,000	86	N/A	756	306	172	123	171 J
Beryllium	mg/kg	2,300	0.63 J	N/A	4.1	0.84 U	1.1	0.98	0.83 J
Cadmium	mg/kg	980	0.18 B	N/A	0.56 B	0.65 B	0.48 B	1.2 B	1.7
Chromium	mg/kg	120,000	31.1	N/A	118	1,930	64.5	91.9	487 J
Chromium VI	mg/kg	6.3	0.35 B	N/A	0.34 B	1.1 B	0.36 B	0.19 B	0.46 B
Cobalt	mg/kg	350	4.1 J	N/A	6.2	0.58 J	9.6	15.6	66.8
Copper	mg/kg	47,000	13.5 J	N/A	37.1	43.6	41.7	67.3	239 J
Iron	mg/kg	820,000	22,000	N/A	65,800	205,000	34,000	66,300	95,400
Lead	mg/kg	800	24.5 J	N/A	13.9	101	19.8	429	194 J
Manganese	mg/kg	26,000	127	N/A	10,100	40,400	997	1,620	1,320
Mercury	mg/kg	350	0.059 J-	N/A	0.0063 J	0.0064 J	0.011 J	0.045 J	0.92
Nickel	mg/kg	22,000	10.7	N/A	25.5	15	39.4	56.6	545 J
Selenium	mg/kg	5,800	4.2 U	N/A	3.7 U	3.4 U	3.5 U	3.4 U	3.8 U
Silver	mg/kg	5,800	3.1 U	N/A	2.8 U	4.6	2.6 U	0.79 J	1.5 J
Thallium	mg/kg	12	10.4 UJ	N/A	9.2 U	35.4	8.8 U	8.5 U	9.5 U
Vanadium	mg/kg	5,800	48.4	N/A	538	10,400	169	235	45.5 J
Zinc	mg/kg	350,000	45.7 J	N/A	22.4	179	69.4	570	414 J
Other									
Cyanide	mg/kg	150	0.76 UJ	N/A	1.2	0.95	0.43 J	0.45 J	2.1 J-

Detections in bold

Values in red indicate an exceedance of the Project Action Limit (PAL)

N/A indicates that the parameter was not analyzed for this sample

* indicates non-validated data

U: This analyte was not detected in the sample. The numeric value represents the ample quantitation/detection limit.

UJ: This analyte was not detected in the sample. The actual quantitation/detection limit may be higher than reported.

J: The positive result reported for this analyte is a quantitative estimate.

J+: The positive result reported for this analyte is a quantitative estimate but may be biased high.

J-: The positive result reported for this analyte is a quantitative estimate but may be biased low.

B: This analyte was not detected substantially above the level of the associated method blank or field blank.

**Table 2 - Sub-Parcel B6-3
Summary of Inorganics Detected in Soil**

Parameter	Units	PAL	B6-073-SB-5	B6-077-SB-1	B6-077-SB-4	B6-079-SB-1	B6-079-SB-7	B6-080-SB-1	B6-080-SB-5
			6/16/2016	6/15/2016	6/15/2016	6/15/2016	6/15/2016	6/16/2016	6/16/2016
Metals									
Aluminum	mg/kg	1,100,000	20,100	14,400	12,900	16,100	10,400	15,700	16,800
Arsenic	mg/kg	3	2.1 U	3.5	4	2.8	2.1 U	5.4	7
Barium	mg/kg	220,000	236 J	275 J	46 J	116 J	24.1 J	54.6 J	140 J
Beryllium	mg/kg	2,300	0.99	1.3	0.35 J	0.81 J	0.21 J	0.48 J	0.87 J
Cadmium	mg/kg	980	0.16 B	1.3	1.4 U	0.55 B	1.3 U	1.5 U	1.3 U
Chromium	mg/kg	120,000	20.2 J	69.8	16.7	32.3	10	22 J	30.8 J
Chromium VI	mg/kg	6.3	0.38 B	0.42 B	0.37 B	0.34 B	0.41 B	0.39 B	0.46 B
Cobalt	mg/kg	350	2.8 J	9.6	3.8 J	7.2	2.8 J	3.5 J	3.9 J
Copper	mg/kg	47,000	9.8 J	22.1	5.3	24.2	3 J	7.1 J	11.8 J
Iron	mg/kg	820,000	10,900	16,200	15,500	18,900	8,750	21,500	29,900
Lead	mg/kg	800	13.1 J	63.3	8.5	58.6	6.1	9 J	11.8 J
Manganese	mg/kg	26,000	496	3,690 J	96.1 J	657 J	47.9 J	61.7	65.2
Mercury	mg/kg	350	0.034 J	0.017 J	0.014 J	0.019 J	0.11 U	0.015 J	0.11 U
Nickel	mg/kg	22,000	7.4 J	24.4	8.7 J	15.6	9.3	9.4 J	11.4 J
Selenium	mg/kg	5,800	3.4 U	3.3 U	3.7 U	4.1 U	3.4 U	4 U	3.6 U
Silver	mg/kg	5,800	2.6 U	2.4 U	2.8 U	3.1 U	2.5 U	3 U	2.7 U
Thallium	mg/kg	12	8.6 U	8.1 U	9.2 U	10.2 U	8.4 U	9.9 U	9 U
Vanadium	mg/kg	5,800	25.2 J	250 J	24.9 J	43.6 J	10.1 J	35.2 J	43.4 J
Zinc	mg/kg	350,000	22.5 J	175	28.2	127	20.6	34.9 J	35.5 J
Other									
Cyanide	mg/kg	150	0.72 UJ	0.82 J+	0.62 U	0.66 U	0.054 J+	0.75 UJ	0.71 UJ

Detections in bold

Values in red indicate an exceedance of the Project Action Limit (PAL)

N/A indicates that the parameter was not analyzed for this sample

* indicates non-validated data

U: This analyte was not detected in the sample. The numeric value represents the ample quantitation/detection limit.

UJ: This analyte was not detected in the sample. The actual quantitation/detection limit may be higher than reported.

J: The positive result reported for this analyte is a quantitative estimate.

J+: The positive result reported for this analyte is a quantitative estimate but may be biased high.

J-: The positive result reported for this analyte is a quantitative estimate but may be biased low.

B: This analyte was not detected substantially above the level of the associated method blank or field blank.

**Table 2 - Sub-Parcel B6-3
Summary of Inorganics Detected in Soil**

Parameter	Units	PAL	B6-081-SB-1	B6-081-SB-5	B6-082-SB-1*	B6-082-SB-5*	B6-085-SB-1*	B6-085-SB-8*
			6/16/2016	6/16/2016	6/17/2016	6/17/2016	6/17/2016	6/17/2016
Metals								
Aluminum	mg/kg	1,100,000	41,300	32,500	18,700	11,200	24,500	11,800
Arsenic	mg/kg	3	3.7	2.3 J	5.5	6.3	7.7	43.7
Barium	mg/kg	220,000	354 J	1,010 J	190	56.2	428	403
Beryllium	mg/kg	2,300	6.2	3.7	1.3	0.53 J	2.2	0.75 J
Cadmium	mg/kg	980	1.1 B	1 B	1.3 B	1.5 U	1 B	8.8
Chromium	mg/kg	120,000	200 J	1,070 J	41	20	248	1,600
Chromium VI	mg/kg	6.3	0.4 B	0.75 B	0.41 B	0.83 B	0.45 B	0.29 B
Cobalt	mg/kg	350	2.7 J	2.9 J	12.4	4.8 J	8.2	173
Copper	mg/kg	47,000	27.3 J	23.9 J	42.8	14.9	73.3	720
Iron	mg/kg	820,000	59,700	72,900	52,100	21,900	77,500	333,000
Lead	mg/kg	800	50 J	47.5 J	244	12	168	2,940
Manganese	mg/kg	26,000	5,340	26,900	2,440	129	11,900	7,840
Mercury	mg/kg	350	0.11 U	0.0088 J	0.018 J	0.008 J	0.0085 J	0.079 J
Nickel	mg/kg	22,000	12.5 J	13.1 J	25.4	14.8	36.7	1,460
Selenium	mg/kg	5,800	3.7 J	4.1 U	3.4 U	3.9 U	3 U	3.7 U
Silver	mg/kg	5,800	2.8 U	1.1 J	2.5 U	2.9 U	2.3 U	7.3
Thallium	mg/kg	12	9.3 U	41.8	8.5 U	9.7 U	7.6 U	9.2 U
Vanadium	mg/kg	5,800	359 J	4,120 J	123	24	250	344
Zinc	mg/kg	350,000	187 J	92.8 J	478	34.7	319	7,360
Other								
Cyanide	mg/kg	150	0.29 B	0.7 J-	0.27 J	0.74 U	0.49 J	1.3

Detections in bold

Values in red indicate an exceedance of the Project Action Limit (PAL)

N/A indicates that the parameter was not analyzed for this sample

* indicates non-validated data

U: This analyte was not detected in the sample. The numeric value represents the ample quantitation/detection limit.

UJ: This analyte was not detected in the sample. The actual quantitation/detection limit may be higher than reported.

J: The positive result reported for this analyte is a quantitative estimate.

J+: The positive result reported for this analyte is a quantitative estimate but may be biased high.

J-: The positive result reported for this analyte is a quantitative estimate but may be biased low.

B: This analyte was not detected substantially above the level of the associated method blank or field blank.

**Table 2 - Sub-Parcel B6-3
Summary of Inorganics Detected in Soil**

Parameter	Units	PAL	B6-086-SB-1*	B6-086-SB-4*	B6-089-SB-1	B6-089-SB-4	B6-093-SB-1*	B6-093-SB-7*
			6/17/2016	6/17/2016	9/19/2016	9/19/2016	9/21/2016	9/21/2016
Metals								
Aluminum	mg/kg	1,100,000	8,190	7,630	32,000	20,400	38,100	11,700
Arsenic	mg/kg	3	8.8	9.2	3.4	4.7	5.2	3.9
Barium	mg/kg	220,000	343	327	279 J	58.5 J	488	38.4
Beryllium	mg/kg	2,300	0.89 U	0.84 U	4.6	0.63 J	5.2	0.42 J
Cadmium	mg/kg	980	1 B	1.5 B	0.8 B	1.6 U	2.3	0.14 B
Chromium	mg/kg	120,000	2,840	2,100	269 J	24.9 J	135	11.6
Chromium VI	mg/kg	6.3	1.1 B	2.5 B	0.4 B	0.25 B	0.39 B	0.86 B
Cobalt	mg/kg	350	2.7 J	4.5	10.5	3.3 J	7.7	2.3 J
Copper	mg/kg	47,000	73.1	76.9	16.7	10.7	77.6	3.5 J
Iron	mg/kg	820,000	122,000	110,000	50,700	18,900	84,200	17,800
Lead	mg/kg	800	18.7	33.4	45.5 J	12.5 J	450	9.1
Manganese	mg/kg	26,000	108,000	79,600	17,600	74.5	9,290	37.2
Mercury	mg/kg	350	0.0034 J	0.11 U	0.11 U	0.049 J	0.0046 J	0.0066 J
Nickel	mg/kg	22,000	35.2	44.2	12.4	9.2 J	32.9	7 B
Selenium	mg/kg	5,800	3.6 U	3.4 U	3.1 UJ	4.1 UJ	2.3 J	3.7 U
Silver	mg/kg	5,800	10.7	8.4	2.3 U	3.1 U	2.3 U	2.7 U
Thallium	mg/kg	12	16.7	15.6	4.9 J	10.4 U	7.8 U	9.2 U
Vanadium	mg/kg	5,800	11,500	8,860	330 J	41.4 J	297	16.4
Zinc	mg/kg	350,000	61.7	134	109 J	40.9 J	2,410	16.9
Other								
Cyanide	mg/kg	150	0.55 U	0.1 J	1	0.11 J	0.44 J	0.69 U

Detections in bold

Values in red indicate an exceedance of the Project Action Limit (PAL)

N/A indicates that the parameter was not analyzed for this sample

* indicates non-validated data

U: This analyte was not detected in the sample. The numeric value represents the ample quantitation/detection limit.

UJ: This analyte was not detected in the sample. The actual quantitation/detection limit may be higher than reported.

J: The positive result reported for this analyte is a quantitative estimate.

J+: The positive result reported for this analyte is a quantitative estimate but may be biased high.

J-: The positive result reported for this analyte is a quantitative estimate but may be biased low.

B: This analyte was not detected substantially above the level of the associated method blank or field blank.

**Table 3 - Sub-Parcel B6-3
Summary of Organics Detected in Groundwater**

Parameter	Units	PAL	FM-008-PZS*	FM-009-PZS	FM-011-PZS*	FM-012-PZS	SW06-PZM001	SW-076-MWS	SW-080-MWS*
			6/17/2016	6/15/2016	6/17/2016	6/30/2016	2/11/2016	6/29/2016	7/1/2016
Volatile Organic Compounds									
1,1-Dichloroethane	µg/L	2.7	1 U	1 U	1 U	1 U	1 U	1 U	5.5
1,1-Dichloroethene	µg/L	7	1 U	1 U	1 U	1 U	1 U	1 U	0.89 J
2-Butanone (MEK)	µg/L	5,600	10 U	10 U	10 U	10.1	10 U	8.5 J	10 U
Acetone	µg/L	14,000	10 U	10 U	10 U	139	10 R	82.3	10 U
Carbon disulfide	µg/L	810	1 U	1 U	2.7	1 U	1 U	1 U	1 U
Ethylbenzene	µg/L	700	0.99 J	1 U	1 U	1 U	1 U	1 U	1 U
Methyl tert-butyl ether (MTBE)	µg/L	14	1 U	1 U	2.6	1 U	1 U	1 U	1 U
Xylenes	µg/L	10,000	2.3 J	3 U	3 U	3 U	3 U	3 U	3 U
Semi-Volatile Organic Compounds[^]									
1,4-Dioxane	µg/L	0.46	0.098 J	0.1 U	0.34	0.1 U	0.1 U	0.1 U	0.26
2,4-Dimethylphenol	µg/L	360	0.58 J	1 U	1 U	1 U	1 U	1 U	1 U
2-Methylnaphthalene	µg/L	36	0.091 J	0.1 UJ	0.1 U	0.044 J	0.1 U	0.1 UJ	0.1 U
3&4-Methylphenol(m&p Cresol)	µg/L	930	1.3 J	2.1 U	2 U	2 U	2 U	2 U	2 U
Acenaphthene	µg/L	530	0.074 J	0.1 U	0.1 U	0.1 U	0.1 U	0.1 U	0.1 U
Acenaphthylene	µg/L	530	0.026 J	0.1 U	0.1 U	0.1 U	0.1 U	0.1 U	0.1 U
Acetophenone	µg/L	1,900	1 U	1 U	1 U	1	1 U	1 U	1 U
Anthracene	µg/L	1,800	0.23	0.078 J	0.1 U	0.11	0.1 U	0.023 J	0.1 U
Benzo[b]fluoranthene	µg/L	0.25	0.1 U	0.1 UJ	0.1 U	0.1 U	0.019 B	0.1 U	0.1 U
bis(2-Ethylhexyl)phthalate	µg/L	6	0.4 J	0.36 J	0.27 J	1 U	1 U	0.2 J	1 U
Fluoranthene	µg/L	800	0.044 J	0.1 U	0.1 U	0.1 U	0.1 U	0.1 U	0.1 U
Fluorene	µg/L	290	0.042 J	0.1 U	0.1 U	0.1 U	0.1 U	0.1 U	0.1 U
Naphthalene	µg/L	0.12	0.63	0.035 B	0.054 B	0.12	0.053 B	0.018 B	0.1 U
Pentachlorophenol	µg/L	1	2.6 U	0.75 J	2.6 U	2.6 U	2.5 U	2.6 U	2.5 U
Phenanthrene	µg/L		0.082 J	0.1 U	0.1 U	0.28	0.1 U	0.1 U	0.1 U
Phenol	µg/L	5,800	1 U	1 U	1 U	1.6	1 U	1 U	1 U
Pyrene	µg/L	120	0.027 J	0.1 U	0.1 U	0.1 U	0.1 U	0.1 U	0.1 U
TPH									
Diesel Range Organics	µg/L	47	939	595 J	103 U	2,460 J	102 UJ	332	69.3 J

Detections in bold

Values in red indicate an exceedance of the Project Action Limit (PAL)

* indicates non-validated data

[^] PAH compounds were analyzed via SIM

U: This analyte was not detected in the sample. The numeric value represents the sample quantitation/detection limit.

UJ: This analyte was not detected in the sample. The actual quantitation/detection limit may be higher than reported.

J: The positive result reported for this analyte is a quantitative estimate.

B: The analyte was not detected substantially above the level of the associated method blank or field blank.

R: The result for this analyte is unreliable. Additional data is needed to confirm or disprove the presence of this analyte in the sample.

**Table 4 - Sub-Parcel B6-3
Summary of Inorganics Detected in Groundwater**

Parameter	Units	PAL	FM-008-PZS*	FM-008-PZS	FM-009-PZS	FM-011-PZS*	FM-012-PZS	SW06-PZM001	SW-076-MWS	SW-080-MWS*
			6/17/2016	7/5/2016	6/15/2016	6/17/2016	6/30/2016	2/11/2016	6/29/2016	7/1/2016
Total Metals										
Aluminum	µg/L	20,000	N/A	N/A	N/A	N/A	N/A	128	2,090	150
Barium	µg/L	2,000	N/A	N/A	N/A	N/A	N/A	28.3	36.7	28.7
Beryllium	µg/L	4	N/A	N/A	N/A	N/A	N/A	1 U	1.4	0.42 J
Cadmium	µg/L	5	N/A	N/A	N/A	N/A	N/A	3 U	1 J	0.83 J
Chromium	µg/L	100	N/A	N/A	N/A	N/A	N/A	0.91 B	1.7 J	5 U
Chromium VI	µg/L	0.035	8,000 [†] J	7 [†] J/9.9 [†]	10 U	10 U	10 U	10 U	10 U	10 U
Cobalt	µg/L	6	N/A	N/A	N/A	N/A	N/A	1.6 B	25.1	24.5
Copper	µg/L	1,300	N/A	N/A	N/A	N/A	N/A	5 U	2.1 J	1.6 J
Iron	µg/L	14,000	N/A	N/A	N/A	N/A	N/A	447	8,750	591
Lead	µg/L	15	N/A	N/A	N/A	N/A	N/A	5 U	4 J	5 U
Manganese	µg/L	430	N/A	N/A	N/A	N/A	N/A	228	596	177
Nickel	µg/L	390	N/A	N/A	N/A	N/A	N/A	7 B	42.2 J	35
Thallium	µg/L	2	N/A	N/A	N/A	N/A	N/A	7.3 B	10 U	10 U
Vanadium	µg/L	86	N/A	N/A	N/A	N/A	N/A	1.1 B	2.3 J	0.55 J
Zinc	µg/L	6,000	N/A	N/A	N/A	N/A	N/A	4.6 B	124 J	31
Dissolved Metals										
Aluminum, Dissolved	µg/L	20,000	193	N/A	34 J	50 U	756	50 U	956	115
Arsenic, Dissolved	µg/L	10	4.6 J	N/A	3.4 J	5 U	5 U	5 U	5 U	5 U
Barium, Dissolved	µg/L	2,000	71	N/A	81.7	25.7	328	27.8	34.8	29
Beryllium, Dissolved	µg/L	4	1 U	N/A	1 U	1 U	1 U	1 U	1.4	0.38 J
Cadmium, Dissolved	µg/L	5	3 U	N/A	3 U	3 U	3 U	3 U	1.3 J	0.72 J
Chromium, Dissolved	µg/L	100	3.6 J	N/A	4 J	5 U	3 J	0.96 J	5 U	5 U
Cobalt, Dissolved	µg/L	6	5 U	N/A	5 U	9.2	5 U	1.4 B	25.8	25
Copper, Dissolved	µg/L	1,300	5 U	N/A	5 U	5 U	11.1	5 U	3.7 J	2.5 J
Iron, Dissolved	µg/L	14,000	70 U	N/A	39.5 J	12,100	70 U	70 U	8,700	597
Lead, Dissolved	µg/L	15	5 U	N/A	5 U	4.1 J	5.4	5 U	5 U	5 U
Manganese, Dissolved	µg/L	430	1.3 J	N/A	25.2	764	5 U	203	595	183
Nickel, Dissolved	µg/L	390	3 J	N/A	2.5 J	8 J	4.8 B	7.1 B	40.9	36.9
Selenium, Dissolved	µg/L	50	10.1	N/A	10.4	8 U	8 U	8 U	8 U	8 U
Thallium, Dissolved	µg/L	2	4.7 J	N/A	3.9 J	10 U	10 U	5.3 B	10 U	10 U
Vanadium, Dissolved	µg/L	86	236	N/A	193	1.4 J	0.69 J	5 U	0.9 J	5 U
Zinc, Dissolved	µg/L	6,000	0.92 B	N/A	0.78 B	5.2 B	3.5 B	4.4 J	127	31.1 B
Other										
Cyanide	µg/L	200	12.1	N/A	3 J	10 U	10 U	10 U	10 U	10 U

Detections in bold

Values in red indicate an exceedance of the Project Action Limit (PAL)

* indicates non-validated data

U: This analyte was not detected in the sample. The numeric value represents the sample quantitation/detection limit.

J: The positive result reported for this analyte is a quantitative estimate.

B: This analyte was not detected substantially above the level of the associated method blank or field blank.

N/A indicates that the parameter was not analyzed for this sample

[†]FM-008-PZS was sampled for Chromium VI on 6/17/2016 and analyzed via Method 7196 which produced a suspect detection of 8,000 µg/L believed to be due to matrix interference. The location was resampled for Chromium VI on 7/5/2016 using low-flow techniques and analyzed via Methods 7196 and 7199 which produced detections of 7 µg/L and 9.9 µg/L, respectively.

**Table 5 - Sub-Parcel B6-3
COPC Screening Analysis**

Parameter	CAS#	Location of Max Result	Max Detection (mg/kg)	Final Flag	Min Detection (mg/kg)	Average Detection (mg/kg)	Total Samples	Frequency of Detection (%)	Cancer TR=1E-06 (mg/kg)	Non-Cancer HQ=0.1 (mg/kg)	COPC?
1,1-Biphenyl	92-52-4	B6-073-SB-1	0.27		0.022	0.08	38	21.05	410	20	no
1,2,4,5-Tetrachlorobenzene	95-94-3	B6-072-SB-1	0.076		0.062	0.07	38	7.89		35	no
1,2-Dichlorobenzene	95-50-1	B6-089-SB-4	0.00085	J	0.00085	0.0009	38	2.63		930	no
2,4-Dimethylphenol	105-67-9	B6-032-SB-1	0.13		0.016	0.06	36	16.67		1,600	no
2-Butanone (MEK)	78-93-3	B6-031-SB-1	0.008	J	0.0023	0.005	38	21.05		19,000	no
2-Chloronaphthalene	91-58-7	B6-072-SB-1	0.21		0.21	0.21	38	2.63		6,000	no
2-Methylnaphthalene	91-57-6	B6-073-SB-1	7.5		0.002	0.35	38	73.68		300	no
2-Methylphenol	95-48-7	B6-073-SB-1	0.11		0.11	0.11	36	2.78		4,100	no
Acenaphthene	83-32-9	B6-073-SB-1 & B6-089-SB-4	0.12		0.00066	0.02	38	71.05		4,500	no
Acenaphthylene	208-96-8	B6-073-SB-1	0.27		0.0012	0.04	38	68.42			no
Acetone	67-64-1	B6-089-SB-4	0.055	J	0.0059	0.03	38	15.79		67,000	no
Acetophenone	98-86-2	B6-073-SB-1	0.16		0.017	0.06	38	10.53		12,000	no
Aluminum	7429-90-5	B6-081-SB-1	41,300		3,790	18,313	38	100.00		110,000	no
Anthracene	120-12-7	B6-073-SB-1	0.9		0.001	0.08	38	84.21		23,000	no
Aroclor 1242	53469-21-9	B6-001-SB-1	0.067		0.067	0.07	19	5.26	0.95		no
Aroclor 1254	11097-69-1	B6-093-SB-1	0.434		0.434	0.43	19	5.26	0.97	1.5	no
Aroclor 1260	11096-82-5	B6-071-SB-1	0.537		0.439	0.49	19	10.53	0.99		no
Arsenic	7440-38-2	B6-085-SB-8	43.7		2.3	8.04	40	90.00	3	48	YES (C)
Barium	7440-39-3	B6-081-SB-5	1,010	J	24.1	225	38	100.00		22,000	no
Benz[a]anthracene	56-55-3	B6-073-SB-1	3.6		0.0017	0.24	38	78.95	21		no
Benzaldehyde	100-52-7	B6-073-SB-1	0.45		0.019	0.09	38	26.32	820	12,000	no
Benzene	71-43-2	B6-002-SB-1	0.0037	J	0.0037	0.004	38	2.63	5.1	42	no
Benzo[a]pyrene	50-32-8	B6-073-SB-1	3.2		0.0012	0.24	39	71.79	2.1	22	YES (C)
Benzo[b]fluoranthene	205-99-2	B6-073-SB-1	5.3		0.0018	0.43	39	82.05	21		no
Benzo[g,h,i]perylene	191-24-2	B6-073-SB-1	1.4		0.0012	0.12	38	68.42			no
Benzo[k]fluoranthene	207-08-9	B6-023-SB-4	3	J	0.0015	0.28	38	84.21	210		no
Beryllium	7440-41-7	B6-081-SB-1	6.2		0.21	1.64	38	89.47	6,900	230	no
bis(2-Ethylhexyl)phthalate	117-81-7	B6-079-SB-7	0.11		0.015	0.05	38	23.68	160	1,600	no
Cadmium	7440-43-9	B6-046-SB-1	11.1		1.3	4.16	38	21.05	9,300	98	no
Caprolactam	105-60-2	B6-093-SB-1	0.021	J	0.021	0.02	38	2.63		40,000	no
Carbazole	86-74-8	B6-073-SB-1	0.4		0.022	0.11	38	21.05			no
Chromium	7440-47-3	B6-086-SB-1	2,840		10	427	38	100.00		180,000	no
Chromium VI	18540-29-9	B6-031-SB-1	3.9	J-	3.9	3.90	38	2.63	6.3	350	no
Chrysene	218-01-9	B6-073-SB-1	4.5		0.0011	0.26	38	84.21	2,100		no
Cobalt	7440-48-4	B6-085-SB-8	173		0.58	16.0	38	94.74	1,900	35	YES (NC)
Copper	7440-50-8	B6-085-SB-8	720		3	78.2	38	100.00		4,700	no

**Table 5 - Sub-Parcel B6-3
COPC Screening Analysis**

Parameter	CAS#	Location of Max Result	Max Detection (mg/kg)	Final Flag	Min Detection (mg/kg)	Average Detection (mg/kg)	Total Samples	Frequency of Detection (%)	Cancer TR=1E-06 (mg/kg)	Non-Cancer HQ=0.1 (mg/kg)	COPC?
Cyanide	57-12-5	B6-073-SB-1	2.1	J-	0.054	0.65	38	63.16		120	no
Dibenz[a,h]anthracene	53-70-3	B6-073-SB-1	0.78		0.0016	0.06	38	57.89	2.1		no
Di-n-butylphthalate	84-74-2	B6-001-SB-1	0.05	J	0.037	0.04	38	5.26		8,200	no
Di-n-ocetylphthalate	117-84-0	B6-093-SB-1	0.04	J	0.04	0.04	38	2.63		820	no
Ethylbenzene	100-41-4	B6-023-SB-4	0.002	J	0.002	0.002	38	2.63	25	2,000	no
Fluoranthene	206-44-0	B6-073-SB-1	4.6		0.00065	0.30	38	89.47		3,000	no
Fluorene	86-73-7	B6-089-SB-4	0.31		0.0006	0.04	38	68.42		3,000	no
Hexachloroethane	67-72-1	B6-073-SB-1	0.057	J	0.057	0.06	38	2.63	8	46	no
Indeno[1,2,3-c,d]pyrene	193-39-5	B6-073-SB-1	1.4		0.0012	0.12	38	68.42	21		no
Iron	7439-89-6	B6-085-SB-8	333,000		8,750	72,559	38	100.00		82,000	YES (NC)
Lead^	7439-92-1	B6-085-SB-8	2,940		2.5	205	38	97.37		800	YES (NC)
Manganese	7439-96-5	B6-086-SB-1	108,000		37.2	11,549	38	100.00		2,600	YES (NC)
Mercury	7439-97-6	B6-073-SB-1	0.92		0.0034	0.06	38	76.32		35	no
Naphthalene	91-20-3	B6-073-SB-1	5.1		0.0029	0.28	38	63.16	8.6	59	no
Nickel	7440-02-0	B6-085-SB-8	1,460		7.4	104	38	97.37	64,000	2,200	no
N-Nitroso-di-n-propylamine	621-64-7	B6-093-SB-1	0.056	J	0.056	0.06	38	2.63	0.33		no
N-Nitrosodiphenylamine	86-30-6	B6-030-SB-1	0.055	J	0.026	0.03	38	10.53	470		no
PCBs (total)*	1336-36-3	B6-093-SB-1	0.873		0.067	0.29	19	31.58	0.94		no
Phenanthrene	85-01-8	B6-073-SB-1	6.5		0.00067	0.31	38	92.11			no
Phenol	108-95-2	B6-073-SB-1	0.11		0.018	0.05	36	8.33		25,000	no
Pyrene	129-00-0	B6-073-SB-1	3.7		0.001	0.28	38	89.47		2,300	no
Selenium	7782-49-2	B6-081-SB-1	3.7	J	2.3	3.00	38	5.26		580	no
Silver	7440-22-4	B6-086-SB-1	10.7		0.74	3.98	38	28.95		580	no
Thallium	7440-28-0	B6-081-SB-5	41.8		4.5	16.5	38	21.05		1.2	YES (NC)
Toluene	108-88-3	B6-023-SB-4	0.0061	J	0.0015	0.004	38	5.26		4,700	no
Vanadium	7440-62-2	B6-086-SB-1	11,500		7.2	1,216	38	100.00		580	YES (NC)
Xylenes	1330-20-7	B6-023-SB-4	0.013	J	0.0049	0.009	38	5.26		250	no
Zinc	7440-66-6	B6-085-SB-8	7,360		16.9	571	38	100.00		35,000	no

J: The positive result reported for this analyte is a quantitative estimate.

J-: The positive result reported for this analyte is a quantitative estimate but may be biased low.

COPC = Constituent of Potential Concern

TR = Target Risk

C = Compound was identified as a cancer COPC

HQ = Hazard Quotient

NC = Compound was identified as a non-cancer COPC

*PCBs (total) include the sum of all detected aroclor mixtures, including those without regional screening levels (e.g. Aroclor 1262, Aroclor 1268) which are not displayed.

^The COPC screening level for lead was not adjusted to the HQ=0.1 because lead is not assessed in the SLRA. The 800 mg/kg PAL is relevant to the Adult Lead Model procedure.

**Table 6 - Sub-Parcel B6-3
Assessment of Lead**

Exposure Unit	Surface/Sub-Surface	Arithmetic Mean (mg/kg)
EU1 (30.3 ac.)	Surface	182
	Sub-Surface	244
	Pooled	213
EU1-EXP (31.0 ac.)	Surface	178
	Sub-Surface	221
	Pooled	200

ALM Risk Levels	
Soil Concentration	Probability of Blood Concentration of 10 ug/dL
2,518 mg/kg	5%
3,216 mg/kg	10%

**Table 7 - Sub-Parcel B6-3
Soil Exposure Point Concentrations**

			EU1 (30.3 ac.)					
			EPCs - Surface Soils		EPCs - Sub-Surface Soils		EPCs - Pooled Soils	
Parameter	Cancer COPC Screening Level (mg/kg)	Non-Cancer COPC Screening Level (mg/kg)	EPC Type	EPC (mg/kg)	EPC Type	EPC (mg/kg)	EPC Type	EPC (mg/kg)
Arsenic	3.00	48.0	95% GROS Adjusted Gamma UCL	14.3	KM H-UCL	10.7	KM H-UCL	9.53
Cobalt	1,900	35.0	95% KM (Chebyshev) UCL	51.6	95% Chebyshev (Mean, Sd) UCL	58.5	95% KM (Chebyshev) UCL	43.5
Iron		82,000	95% Student's-t UCL	118,904	95% Chebyshev (Mean, Sd) UCL	151,422	95% H-UCL	120,314
Manganese		2,600	95% Adjusted Gamma UCL	32,562	99% Chebyshev (Mean, Sd) UCL	58,388	95% Adjusted Gamma UCL	21,824
Thallium		1.20	KM H-UCL	6.46	Maximum Value	35.4	95% KM (t) UCL	9.08
Vanadium		580	99% Chebyshev (Mean, Sd) UCL	8,068	99% Chebyshev (Mean, Sd) UCL	8,895	97.5% Chebyshev (Mean, Sd) UCL	4,400
Benzo[a]pyrene	2.10	22.0	99% KM (Chebyshev) UCL	2.11	Gamma Adjusted KM-UCL	0.59	95% KM (Chebyshev) UCL	0.62

Bold indicates EPC higher than lowest COPC Screening Level
COPC = Constituent of Potential Concern

**Table 7 - Sub-Parcel B6-3
Soil Exposure Point Concentrations**

			EU1-EXP (31.0 ac.)					
			EPCs - Surface Soils		EPCs - Sub-Surface Soils		EPCs - Pooled Soils	
Parameter	Cancer COPC Screening Level (mg/kg)	Non-Cancer COPC Screening Level (mg/kg)	EPC Type	EPC (mg/kg)	EPC Type	EPC (mg/kg)	EPC Type	EPC (mg/kg)
Arsenic	3.00	48.0	95% GROS Adjusted Gamma UCL	12.6	KM H-UCL	9.98	KM H-UCL	8.93
Cobalt	1,900	35.0	95% KM (Chebyshev) UCL	47.1	95% Chebyshev (Mean, Sd) UCL	52.8	95% KM (Chebyshev) UCL	39.6
Iron		82,000	95% Student's-t UCL	112,385	95% Chebyshev (Mean, Sd) UCL	140,736	95% H-UCL	108,656
Manganese		2,600	95% Adjusted Gamma UCL	27,826	99% Chebyshev (Mean, Sd) UCL	54,826	95% Adjusted Gamma UCL	20,086
Thallium		1.20	KM H-UCL	6.29	95% KM (t) UCL	15.6	95% KM (t) UCL	10.3
Vanadium		580	99% Chebyshev (Mean, Sd) UCL	7,265	99% Chebyshev (Mean, Sd) UCL	8,356	95% Chebyshev (Mean, Sd) UCL	3,237
Benzo[a]pyrene	2.10	22.0	95% KM (Chebyshev) UCL	0.96	97.5% KM (Chebyshev) UCL	0.58	95% KM (Chebyshev) UCL	0.56

Bold indicates EPC higher than lowest COPC Screening Level
COPC = Constituent of Potential Concern

**Table 8 - Sub-Parcel B6-3
Surface Soils
Composite Worker Risk Ratios**

Parameter	Target Organs	Site-Wide EU1 (30.3 ac.)				
		EPC (mg/kg)	Composite Worker			
			RSLs (mg/kg)		Risk Ratios	
			Cancer	Non-Cancer	Risk	HQ
Arsenic	Cardiovascular; Dermal	14.3	3.00	480	4.8E-06	0.03
Cobalt	Thyroid	51.6	1,900	350	2.7E-08	0.1
Iron	Gastrointestinal	118,904		820,000		0.1
Manganese	Nervous	32,562		26,000		1
Thallium	Dermal	6.46		12.0		0.5
Vanadium	Dermal	8,068		5,800		1
Benzo(a)pyrene	Developmental	2.11	2.10	220	1.0E-06	0.01
					6E-06	↓

RSLs were obtained from the EPA Regional Screening Levels at https://epa-prgs.ornl.gov/cgi-bin/chemicals/csl_search

Total HI	Cardiovascular	0
	Dermal	2
	Thyroid	0
	Gastrointestinal	0
	Nervous	1
	Developmental	0

**Table 9 - Sub-Parcel B6-3
Sub-Surface Soils
Composite Worker Risk Ratios**

Parameter	Target Organs	Site-Wide EU1 (30.3 ac.)				
		EPC (mg/kg)	Composite Worker			
			RSLs (mg/kg)		Risk Ratios	
			Cancer	Non-Cancer	Risk	HQ
Arsenic	Cardiovascular; Dermal	10.7	3.00	480	3.6E-06	0.02
Cobalt	Thyroid	58.5	1,900	350	3.1E-08	0.2
Iron	Gastrointestinal	151,422		820,000		0.2
Manganese	Nervous	58,388		26,000		2
Thallium	Dermal	35.4		12.0		3
Vanadium	Dermal	8,895		5,800		2
Benzo(a)pyrene	Developmental	0.59	2.10	220	2.8E-07	0.003
					4E-06	↓

Bold indicates maximum value

RSLs were obtained from the EPA Regional Screening Levels at
https://epa-prgs.ornl.gov/cgi-bin/chemicals/csl_search

Total HI	Cardiovascular	0
	Dermal	5
	Thyroid	0
	Gastrointestinal	0
	Nervous	2
	Developmental	0

**Table 10 - Sub-Parcel B6-3
Pooled Soils
Composite Worker Risk Ratios**

Parameter	Target Organs	Site-Wide EU1 (30.3 ac.)				
		EPC (mg/kg)	Composite Worker			
			RSLs (mg/kg)		Risk Ratios	
			Cancer	Non-Cancer	Risk	HQ
Arsenic	Cardiovascular; Dermal	9.53	3.00	480	3.2E-06	0.02
Cobalt	Thyroid	43.5	1,900	350	2.3E-08	0.1
Iron	Gastrointestinal	120,314		820,000		0.1
Manganese	Nervous	21,824		26,000		0.8
Thallium	Dermal	9.08		12.0		0.8
Vanadium	Dermal	4,400		5,800		0.8
Benzo(a)pyrene	Developmental	0.62	2.10	220	3.0E-07	0.003
					3E-06	↓

RSLs were obtained from the EPA Regional Screening Levels at https://epa-prgs.ornl.gov/cgi-bin/chemicals/csl_search

Total HI	Cardiovascular	0
	Dermal	2
	Thyroid	0
	Gastrointestinal	0
	Nervous	1
	Developmental	0

**Table 11 - Sub-Parcel B6-3
Surface Soils
Construction Worker Risk Ratios**

25 Day		Site-Wide EU1-EXP (31.0 ac.)				
Parameter	Target Organs	EPC (mg/kg)	Construction Worker			
			SSLs (mg/kg)		Risk Ratios	
			Cancer	Non-Cancer	Risk	HQ
Arsenic	Cardiovascular; Dermal	12.6	151	963	8.3E-08	0.01
Cobalt	Thyroid	47.1	43,464	9,438	1.1E-09	0.005
Iron	Gastrointestinal	112,385		2,405,413		0.05
Manganese	Nervous	27,826		41,356		0.7
Thallium	Dermal	6.29		137		0.05
Vanadium	Dermal	7,265		15,963		0.5
Benzo(a)pyrene	Developmental	0.96	164	32.8	5.9E-09	0.03
					9E-08	↓

SSLs calculated using equations in the EPA Supplemental Guidance dated 2002

Guidance Equation Input Assumptions:

5 cars/day (2 tons/car)

5 trucks/day (20 tons/truck)

3 meter source depth thickness

Total HI	Cardiovascular	0
	Dermal	1
	Thyroid	0
	Gastrointestinal	0
	Nervous	1
	Developmental	0

**Table 12 - Sub-Parcel B6-3
Sub-Surface Soils
Construction Worker Risk Ratios**

25 Day		Site-Wide EU1-EXP (31.0 ac.)				
Parameter	Target Organs	EPC (mg/kg)	Construction Worker			
			SSLs (mg/kg)		Risk Ratios	
			Cancer	Non-Cancer	Risk	HQ
Arsenic	Cardiovascular; Dermal	9.98	151	963	6.6E-08	0.01
Cobalt	Thyroid	52.8	43,464	9,438	1.2E-09	0.006
Iron	Gastrointestinal	140,736		2,405,413		0.06
Manganese	Nervous	54,826		41,356		1
Thallium	Dermal	15.6		137		0.1
Vanadium	Dermal	8,356		15,963		0.5
Benzo(a)pyrene	Developmental	0.58	164	32.8	3.5E-09	0.02
					7E-08	↓

SSLs calculated using equations in the EPA Supplemental Guidance dated 2002

Guidance Equation Input Assumptions:

5 cars/day (2 tons/car)

5 trucks/day (20 tons/truck)

3 meter source depth thickness

Total HI	Cardiovascular	0
	Dermal	1
	Thyroid	0
	Gastrointestinal	0
	Nervous	1
	Developmental	0

**Table 13 - Sub-Parcel B6-3
Pooled Soils
Construction Worker Risk Ratios**

25 Day		Site-Wide EU1-EXP (31.0 ac.)				
Parameter	Target Organs	EPC (mg/kg)	Construction Worker			
			SSLs (mg/kg)		Risk Ratios	
			Cancer	Non-Cancer	Risk	HQ
Arsenic	Cardiovascular; Dermal	8.93	151	963	5.9E-08	0.009
Cobalt	Thyroid	39.6	43,464	9,438	9.1E-10	0.004
Iron	Gastrointestinal	108,656		2,405,413		0.05
Manganese	Nervous	20,086		41,356		0.5
Thallium	Dermal	10.3		137		0.08
Vanadium	Dermal	3,237		15,963		0.2
Benzo(a)pyrene	Developmental	0.56	164	32.8	3.4E-09	0.02
					6E-08	↓

SSLs calculated using equations in the EPA Supplemental Guidance dated 2002

Guidance Equation Input Assumptions:

- 5 cars/day (2 tons/car)
- 5 trucks/day (20 tons/truck)
- 3 meter source depth thickness

Total HI	Cardiovascular	0
	Dermal	0
	Thyroid	0
	Gastrointestinal	0
	Nervous	0
	Developmental	0

"

"

"

"

"

"

"

"

"

APPENDIX A

"

"

"

"

"

"

"

"

"

"

"

"



**TRADEPOINT
ATLANTIC**

1600 Sparrows Point Boulevard
Baltimore, Maryland 21219

April 17, 2020

Maryland Department of Environment
1800 Washington Boulevard
Baltimore MD, 21230

Attention: Ms. Barbara Brown

Subject: Request to Enter Temporary CHS Review
Tradepoint Atlantic Parcel B6-3

Dear Ms. Brown:

The conduct of any environmental assessment and cleanup activities on the Tradepoint Atlantic property, as well as any associated development, is subject to the requirements outlined in the following agreements:

- Administrative Consent Order (ACO) between Tradepoint Atlantic (formerly Sparrows Point Terminal, LLC) and the Maryland Department of the Environment (effective September 12, 2014); and
- Settlement Agreement and Covenant Not to Sue (SA) between Tradepoint Atlantic (formerly Sparrows Point Terminal, LLC) and the United States Environmental Protection Agency (effective November 25, 2014).

On September 11, 2014, Tradepoint Atlantic submitted an application to the Maryland Department of the Environment's (Department) Voluntary Cleanup Program (VCP).

In consultation with the Department, Tradepoint Atlantic affirms that it desires to accelerate the assessment, remediation and redevelopment of certain sub-parcels within the larger site due to current market conditions. To that end, the Department and Tradepoint Atlantic agree that the Controlled Hazardous Substance (CHS) Act (Section 7-222 of the Environment Article) and the CHS Response Plan (COMAR 26.14.02) shall serve as the governing statutory and regulatory authority for completing the development activities on Sub-Parcel B6-3 and complement the statutory requirements of the Voluntary Cleanup Program (Section 7-501 of the Environment Article). Upon submission of a Site Response and Development Work Plan and completion of the remedial activities for the sub-parcel, the Department shall issue a "No Further Action" letter upon a recordation of an environmental covenant describing any necessary land use controls for the specific sub-parcel. At such time that all the sub-parcels within the larger parcel have completed remedial activities, Tradepoint Atlantic shall submit to the Department a request for issuing a Certificate of Completion (COC) as well as all pertinent information concerning completion of remedial activities conducted on the parcel. Once the VCP has completed its review of the



**TRADEPOINT
ATLANTIC**

1600 Sparrows Point Boulevard
Baltimore, Maryland 21219

submitted information it shall issue a COC for the entire parcel described in TradePoint Atlantic's VCP application.

Alternatively, TradePoint Atlantic or other entity may elect to submit an application for a specific sub-parcel and submit it to the VCP for review and acceptance. If the application is received after the cleanup and redevelopment activities described in this work plan are implemented and a No Further Action letter is issued by the Department pursuant to the CHS Act, the VCP shall prepare a No Further Requirements Determination for the sub-parcel.

If TradePoint Atlantic or other entity has not carried out cleanup and redevelopment activities described in the work plan, the cleanup and redevelopment activities may be conducted under the oversight authority of either the VCP or the CHS Act, so long as those activities comport with this work plan.

Engineering and institutional controls approved as part of this Site Response and Development Work Plan shall be described in documentation submitted to the Department demonstrating that the exposure pathways on the sub-parcel are addressed in a manner that protects public health and the environment. This information shall support TradePoint Atlantic's request for the issuance of a COC for the larger parcel.

Please do not hesitate to contact TradePoint Atlantic for further information.

Thank you,

Peter Haid

Vice President Environmental
TRADEPOINT ATLANTIC
1600 Sparrows Point Boulevard
Baltimore, Maryland 21219
T 443.649.5055 C 732.841.7935
phaid@tradeointatlantic.com

"

"

"

"

"

"

"

"

"

APPENDIX B

"

"

"

"

"

"

"

"

"

"

"

"

**Construction Worker Soil Screening Levels
Maximum Allowable Work Day Exposure
Calculation Spreadsheet - Sub-Parcel B6-3**

Description	Variable	Value
Days worked per week	DW	5
Exposure duration (yr)	ED	1
Hours worked per day	ET	8
A/constant (unitless) - particulate emission factor	Aconst	12.9351
B/constant (unitless) - particulate emission factor	Bconst	5.7383
C/constant (unitless) - particulate emission factor	Cconst	71.7711
Dispersion correction factor (unitless)	FD	0.185
Days per year with at least .01" precipitation	P	130
Target hazard quotient (unitless)	THQ	1
Body weight (kg)	BW	80
Averaging time - noncancer (yr)	ATnc	1
Soil ingestion rate (mg/d)	IR	330
Skin-soil adherence factor (mg/cm ²)	AF	0.3
Skin surface exposed (cm ²)	SA	3300
Event frequency (ev/day)	EV	1
Target cancer risk (unitless)	TR	01E-06
Averaging time - cancer (yr)	ATc	70
A/constant (unitless) - volatilization	Aconstv	2.4538
B/constant (unitless) - volatilization	Bconstv	17.566
C/constant (unitless) - volatilization	Cconstv	189.0426
Dry soil bulk density (kg/L)	Pb	1.5
Average source depth (m)	ds	3
Soil particle density (g/cm ³)	Ps	2.65
Total soil porosity	Lpore/Lsoil	0.43
Air-filled soil porosity	Lair/Lsoil	0.28

**Construction Worker Soil Screening Levels
Maximum Allowable Work Day Exposure
Calculation Spreadsheet - Sub-Parcel B6-3**

Area of site (ac)	Ac	31.0	→ EU1-EXP
Overall duration of construction (wk/yr)	EW	5	
Exposure frequency (day/yr)	EF	25	
Cars per day	Ca	5	
Tons per car	CaT	2	
Trucks per day	Tru	5	
Tons per truck	TrT	20	
Mean vehicle weight (tons)	w	11	
Derivation of dispersion factor - particulate emission factor (g/m2-s per kg/m3)	Q/Csr	13.9	
Overall duration of traffic (s)	Tt	720,000	
Surface area (m2)	AR	125,453	
Length (m)	LR	354	
Distance traveled (km)	ΣVKT	89	
Particulate emission factor (m3/kg)	PEFsc	127,585,885	
Derivation of dispersion factor - volatilization (g/m2-s per kg/m3)	Q/Csa	7.06	
Total time of construction (s)	Tcv	720,000	

Input
Calculation

Chemical	Toxicity Criteria Source	[^] Ingestion SF (mg/kg-day) ⁻¹	[^] Inhalation Unit Risk (ug/m ³) ⁻¹	[^] Subchronic RfD (mg/kg-day)	[^] Subchronic RfC (mg/m ³)	[^] GIABS	Dermally Adjusted RfD (mg/kg-day)	[^] ABS	[^] RBA	*Dia	*Diw	*Henry's Law Constant (unitless)	*Kd	*Koc	DA	Volatilization Factor - Unlimited Reservoir (m ³ /kg)	Carcinogenic Ingestion/ Dermal SL (SLing/der)	Carcinogenic Inhalation SL (SLinh)	Carcinogenic SL (mg/kg)	Non-Carcinogenic Ingestion/ Dermal SL (SLing/der)	Non-Carcinogenic Inhalation SL (SLinh)	Non-Carcinogenic SL (mg/kg)
Arsenic, Inorganic	I/C	1.50E+00	4.30E-03	3.00E-04	1.50E-05	1	3.00E-04	0.03	0.6			-	2.90E+01				152	90,972	151	974	83,824	963
Cobalt	P	-	9.00E-03	3.00E-03	2.00E-05	1	3.00E-03	0.01	1			-	4.50E+01					43,464	43,464	10,309	111,765	9,438
Iron	P	-	-	7.00E-01	-	1	7.00E-01	0.01	1			-	2.50E+01							2,405,413		2,405,413
Manganese (Non-diet)	I	-	-	2.40E-02	5.00E-05	0.04	9.60E-04	0.01	1			-	6.50E+01							48,540	279,413	41,356
Thallium (Soluble Salts)	P	-	-	4.00E-05	-	1	4.00E-05	0.01	1			-	7.10E+01							137		137
Vanadium and Compounds	A	-	-	1.00E-02	1.00E-04	0.026	2.60E-04	0.01	1			-	1.00E+03							16,433	558,826	15,963
Benzo[a]pyrene	I	1.00E+00	6.00E-04	3.00E-04	2.00E-06	1	3.00E-04	0.13	1	4.80E-02	5.60E-06	1.87E-05	3.54E+03	5.90E+05	2.37E-11	3.93E+5	178	2,002	164	764	34.3	32.8

*chemical specific parameters found in Chemical Specific Parameters Spreadsheet at <https://www.epa.gov/risk/regional-screening-levels-rsls>
[^]chemical specific parameters found in Unpaved Road Traffic calculator at https://epa-prgs.ornl.gov/cgi-bin/chemicals/csl_search
I: chemical specific parameters found in the IRIS at <https://www.epa.gov/iris>
C: chemical specific parameters found in Cal EPA at <https://www.dtsc.ca.gov/AssessingRisk>
A: chemical specific parameters found in Agency for Toxic Substances and Disease Registry Minimal Risk Levels (MRLs) at https://www.atsdr.cdc.gov/mrls/pdfs/atsdr_mrls.pdf
P: chemical specific parameters found in the Database of EPA PPRTVs at <https://hhpprtv.ornl.gov/quickview/pprtv.php>

APPENDIX C

Sparrows Point Development - PPE Standard

Operational Procedure, Revision 3

Planning, Tracking/Supervision, Enforcement, and Documentation

Planning

- Response and Development Work Plan (RDWP) for each individual redevelopment sub-parcel identifies and documents site conditions.
- RDWP is reviewed and approved by regulators.
- Contractor HASP to address site-specific conditions and PPE requirements:
 - Contractor H&S professional to sign-off on PPE requirements for site workers;
 - Job Safety Analysis (JSA) to be performed for ground intrusive work.
- Project Environmental Professional (EP) assigned to each construction project – monitors project during environmentally sensitive project phases and is available to construction contractor on an as needed basis. EP responsibilities include the following:
 - Dust monitoring
 - Routine ground intrusive breathing space air monitoring
 - Soil tracking
 - Water handling oversight
 - Ground intrusive work observation
 - Notification for unexpected conditions
- Pre-construction meeting identifies EP roles and responsibilities and reviews site conditions.
- Contractor to perform job-site HazCom. HazCom to be addressed in Contractor HASP and include:
 - PPE requirements,
 - Exposure time limits,
 - Identification of chemicals of concern and potential effects of over-exposure (adverse reactions),
 - Methods and routes of potential exposure.
- All personnel that will be performing ground intrusive work within impacted soils shall sign-off on HazCom.
- If, based on a thorough review of Site conditions, it is expected that construction workers will have the potential to encounter materials considered hazardous waste under RCRA or DOT regulations, HAZWOPER-trained personnel will be utilized.

Tracking/Supervision

- Contractor to record any day that there is ground intrusive work and confirm that proper PPE is being worn.
- EP will note ground intrusive work on daily work sheets and perform at least one spot check per day.
- EP will log on daily work sheets PPE compliance for all intrusive work areas at least once per day.

- EP to take example photos of Exclusion Zones/Contamination Reduction Zones periodically.

Work Zones Delineation

- Exclusion Zone – The Exclusion Zones will include the areas proposed for excavation or with active trenches, excavations, or ground intrusive work, at a minimum. Personnel working within the exclusion zone will be required to wear Modified Level D PPE as described in this SOP. EP to take example photos of Exclusion Zones/Contamination Reduction Zones periodically. The Exclusion Zones will be identified each work day.
- Contamination Reduction Zone – This work zone is located outside of the exclusion zone, but inside of the limits of development (LOD). The Contamination Reduction Zone will be located adjacent to the Exclusion Zone, and all personal decontamination including removal of all disposable PPE/removal of soil from boots will be completed in the Contamination Reduction Zone.

Documentation

- Contractor HASP and HazCom.
- Contractor ground intrusive tracking record.
- HASP and HazCom sign-in sheets.
- EP pre-con memos.
- EP daily work sheets.
- Records documenting intrusive work and proper PPE use to be provided in completion report.

Enforcement

- Non-compliance of PPE requirements will result in disciplinary action up to and including prohibition from working on Sparrows Point.

Unknown and/or Unexpected Conditions

If unknown and/or unexpected conditions are encountered during the project that the EP determines to have a reasonable potential to significantly impact construction worker health and safety, the following will be initiated:

1. Job stoppage,
2. TPA and MDE notification,
3. Re-assessment of conditions.

Work will not continue until EP has cleared the area. If hazardous waste is identified, a HAZWOPER contractor will be brought in to address. The approved contingency plan will be implemented, where appropriate.

Modified Level D PPE

Modified Level D PPE will include, at a minimum, overalls such as polyethylene-coated Tyvek or clean washable cloth overalls, latex (or similar) disposable gloves (when working in wet/chemical surroundings) or work gloves, steel-toe/steel-shank high ankle work boots with taped chemical-protective over-boots (as necessary), dust mask, hard hat, safety glasses with

side shields, and hearing protection (as necessary). If chemical-protective over-boots create increased slip/trip/fall hazardous, then standard leather or rubber work boots could be used, but visible soils from the sides and bottoms of the boots must be removed upon exiting the Exclusion Zone.

SP Development PPE Procedure 4-3-19

APPENDIX D

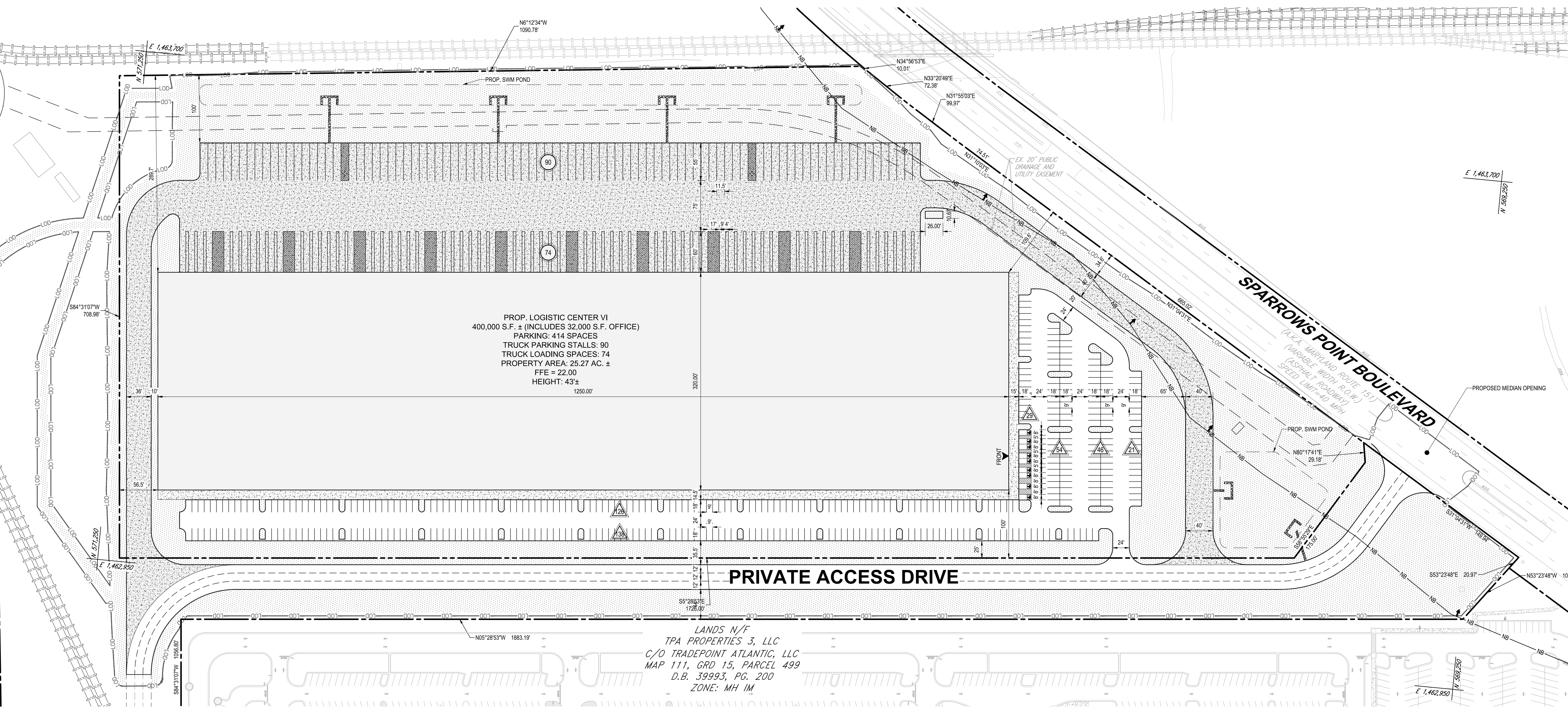
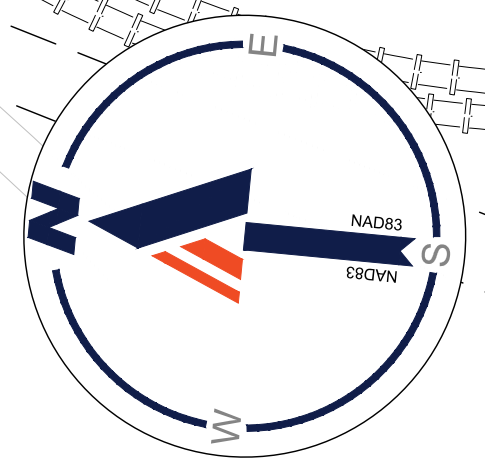

PROP. LOGISTIC CENTER VI
 400,000 S.F. ± (INCLUDES 32,000 S.F. OFFICE)
 PARKING: 414 SPACES
 TRUCK PARKING STALLS: 90
 TRUCK LOADING SPACES: 74
 PROPERTY AREA: 25.27 AC. ±
 FFE = 22.00
 HEIGHT: 43' ±
 1250.00'

LANDS N/F
 TPA PROPERTIES 3, LLC
 C/O TRADEPOINT ATLANTIC, LLC
 MAP 111, GRD 15, PARCEL 499
 D.B. 39993, PG. 200
 ZONE: MH 1M

PRIVATE ACCESS DRIVE

SPARROWS POINT BOULEVARD
 (A.K.A. MARYLAND ROUTE 197)
 (VARIABLE WIDTH ROADWAY)
 SPEED LIMIT = 40 MPH

LEGEND

- CONCRETE SIDEWALK
- STANDARD DUTY ASPHALT PAVEMENT
- HEAVY DUTY CONCRETE PAVEMENT
- PROPOSED AREA TO BE LANDSCAPED
- NB CRITICAL AREA BUFFER

NOTES

1. APPROXIMATE CUT = 6,562 CY*
 APPROXIMATE FILL = 39,201 CY*
 2. EXCAVATED MATERIAL TO BE REUSED ON-SITE IF DEEMED SUITABLE FOR REUSE.
- *CUT/FILL VALUES ARE GENERATED BY COMPARING THE FINAL GRADE TO THE MASS GRADE CONDITION.

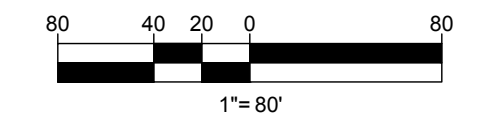

BOHLER
 SITE CIVIL AND CONSULTING ENGINEERING
 PROGRAM MANAGEMENT
 LANDSCAPE ARCHITECTURE
 SUSTAINABLE DESIGN
 PERMITTING SERVICES
 TRANSPORTATION SERVICES

REVISIONS

REV	DATE	COMMENT	DRAWN BY	CHECKED BY

811
 Know what's below.
 Call before you dig.
 ALWAYS CALL 811
 It's fast. It's free. It's the law.

NOT APPROVED FOR CONSTRUCTION

PROJECT No.: MD1620669
 DRAWN BY: ISL
 CHECKED BY: MJG
 DATE: 03/06/2020
 CAD I.D.: SSP-9

PROJECT VIPER
 FOR
TRADEPOINT ATLANTIC
 PRELIMINARY PLAN
 SPARROWS POINT BOULEVARD
 BALTIMORE, MD 21219
 TM 111, GRID 14, PARCEL 318
 ELECTION DISTRICT 15
 COUNCILMANIC DISTRICT 7
 BALTIMORE COUNTY

BOHLER
 901 DULANEY VALLEY ROAD, SUITE 801
 TOWSON, MARYLAND 21204
 Phone: (410) 821-7900
 Fax: (410) 821-7987
 MD@BohlerEng.com

M.J. GESELL
 PROFESSIONAL ENGINEER
 MARYLAND LICENSE NO. 44097
 PROFESSIONAL CERTIFICATION
 I, MICHAEL J. GESELL, HEREBY CERTIFY THAT THESE DOCUMENTS WERE PREPARED OR APPROVED BY ME, AND THAT I AM A DULY LICENSED PROFESSIONAL ENGINEER UNDER THE LAWS OF THE STATE OF MARYLAND. LICENSE NO. 44097, EXPIRATION DATE: 6/30/21

SHEET TITLE:
SITE PLAN
 SHEET NUMBER:
1
 ORG. DATE - 03/06/2020

H:\16\MD1620669\DRAWINGS\PLAN SETS\PRELIMINARY PLAN\MD1620669-SSP-9.dwg - LAYOUT - 01 - SITE PLAN

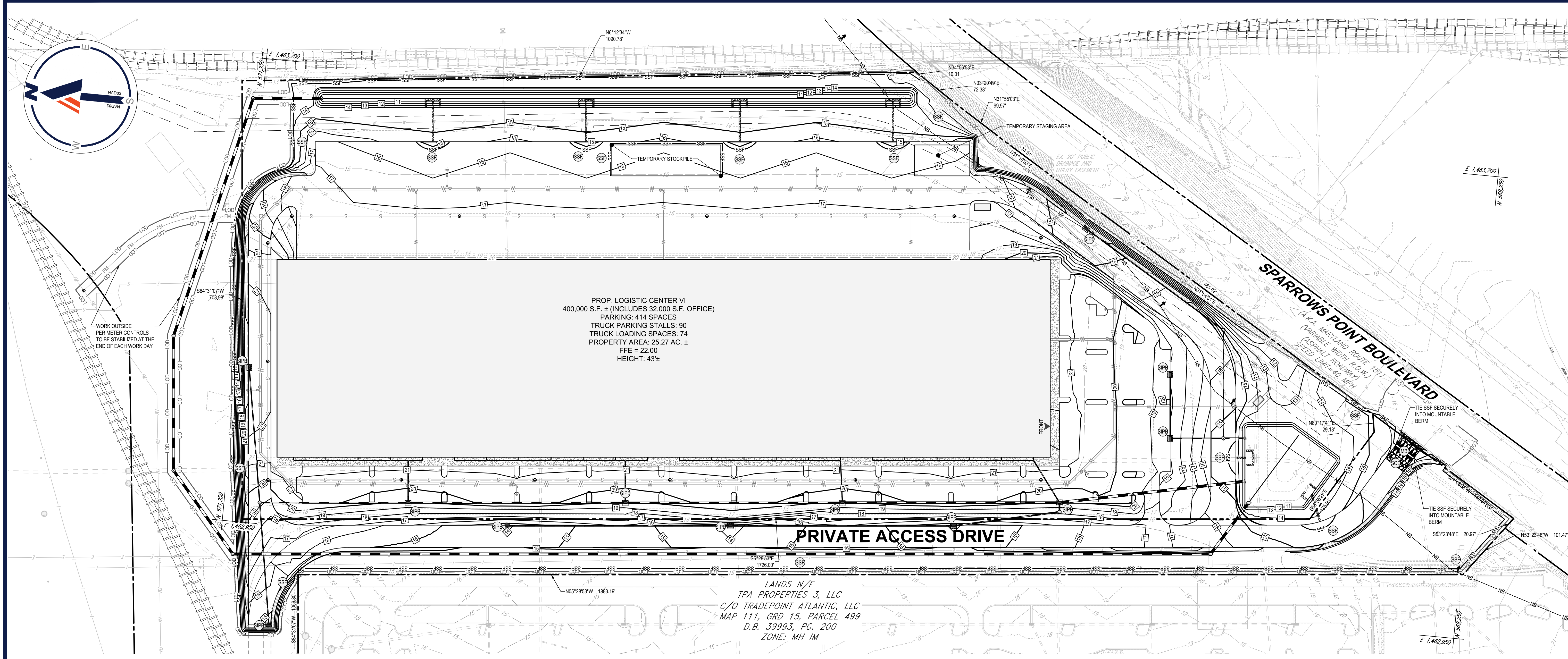
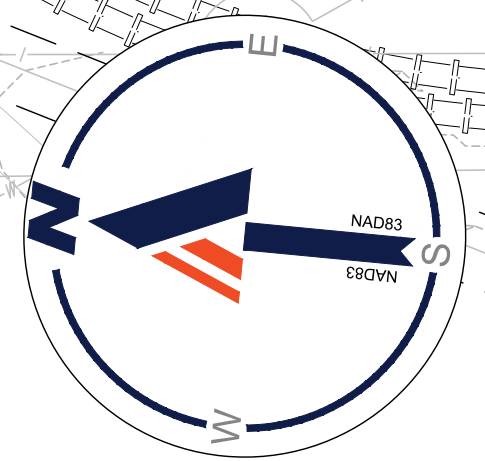

PROP. LOGISTIC CENTER VI
 400,000 S.F. ± (INCLUDES 32,000 S.F. OFFICE)
 PARKING: 414 SPACES
 TRUCK PARKING STALLS: 90
 TRUCK LOADING SPACES: 74
 PROPERTY AREA: 25.27 AC. ±
 FFE = 22.00
 HEIGHT: 43'±

LANDS N/F
 TPA PROPERTIES 3, LLC
 C/O TRADEPOINT ATLANTIC, LLC
 MAP 111, GRD 15, PARCEL 499
 D.B. 39993, PG. 200
 ZONE: MH 1M

STANDARD SYMBOLS
 FOR EROSION AND SEDIMENT CONTROL PRACTICES

TITLE	KEY	SYMBOL
STABILIZED STONE CONSTRUCTION ENTRANCE	SC	
MOUNTABLE BERM	MB	
SUPER SILT FENCE	SSF	
LIMITS OF DISTURBANCE	LOD	
STANDARD INLET PROTECTION TYPE 'B'	SP	

LEGEND

EXISTING	PROPOSED
PROPERTY LINE	
CONTOURS	
SANITARY SEWER	
WATER	
UNDERGROUND ELECTRIC	
OVERHEAD ELECTRIC	
UNDERGROUND TELEPHONE	
UNDERGROUND GAS	
STORMDRAIN	
CURB AND GUTTER	
SPILL CURB	

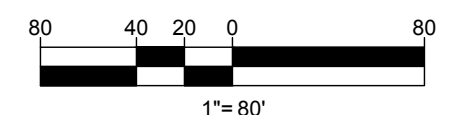

BOHLER
 SITE CIVIL AND CONSULTING ENGINEERING
 PROGRAM MANAGEMENT
 LANDSCAPE ARCHITECTURE
 SUSTAINABLE DESIGN
 PERMITTING SERVICES
 TRANSPORTATION SERVICES

REVISIONS

REV	DATE	COMMENT	DRAWN BY	CHECKED BY

811
 Know what's below.
 Call before you dig.
 ALWAYS CALL 811
 It's fast. It's free. It's the law.

NOT APPROVED FOR CONSTRUCTION

THIS DRAWING IS INTENDED FOR MUNICIPAL AND/OR AGENCY REVIEW AND APPROVAL. IT IS NOT INTENDED AS A CONSTRUCTION DOCUMENT UNLESS INDICATED OTHERWISE.

PROJECT No.: MD1620669
 DRAWN BY: ISL
 CHECKED BY: MJG
 DATE: 03/06/2020
 CAD I.D.: SSP-D

PROJECT VIPER

FOR

TRADEPOINT ATLANTIC

PRELIMINARY PLAN

SPARROWS POINT BOULEVARD
 BALTIMORE, MD 21219
 TM 111, GRID 14, PARCEL 318
 ELECTION DISTRICT 15
 COUNCILMANIC DISTRICT 7
 BALTIMORE COUNTY

BOHLER

901 DULANEY VALLEY ROAD, SUITE 801
 TOWSON, MARYLAND 21204
 Phone: (410) 821-7900
 Fax: (410) 821-7987
 MD@BohlerEng.com

M.J. GESELL

PROFESSIONAL ENGINEER

I, MICHAEL J. GESELL, HEREBY CERTIFY THAT THESE DOCUMENTS WERE PREPARED OR APPROVED BY ME, AND THAT I AM A DULY LICENSED PROFESSIONAL ENGINEER UNDER THE LAWS OF THE STATE OF MARYLAND, LICENSE NO. 44097, EXPIRATION DATE: 6/30/21

SHEET TITLE:
GRADING PLAN

SHEET NUMBER:
2

ORG. DATE - 03/06/2020

H:\16MD1620669\DRAWINGS\PLAN SETS\PRELIMINARY PLANS\MD1620669-SSP-D-1-JAYOUT-02-GRADING PLAN

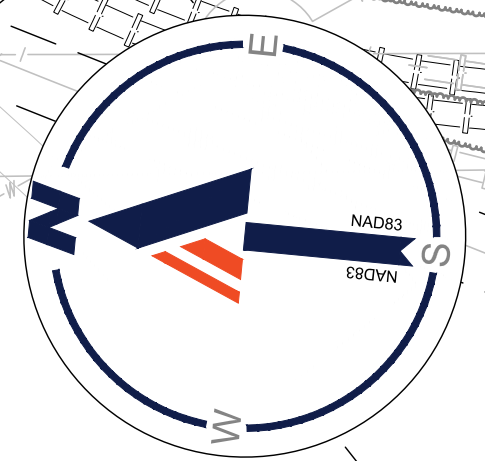
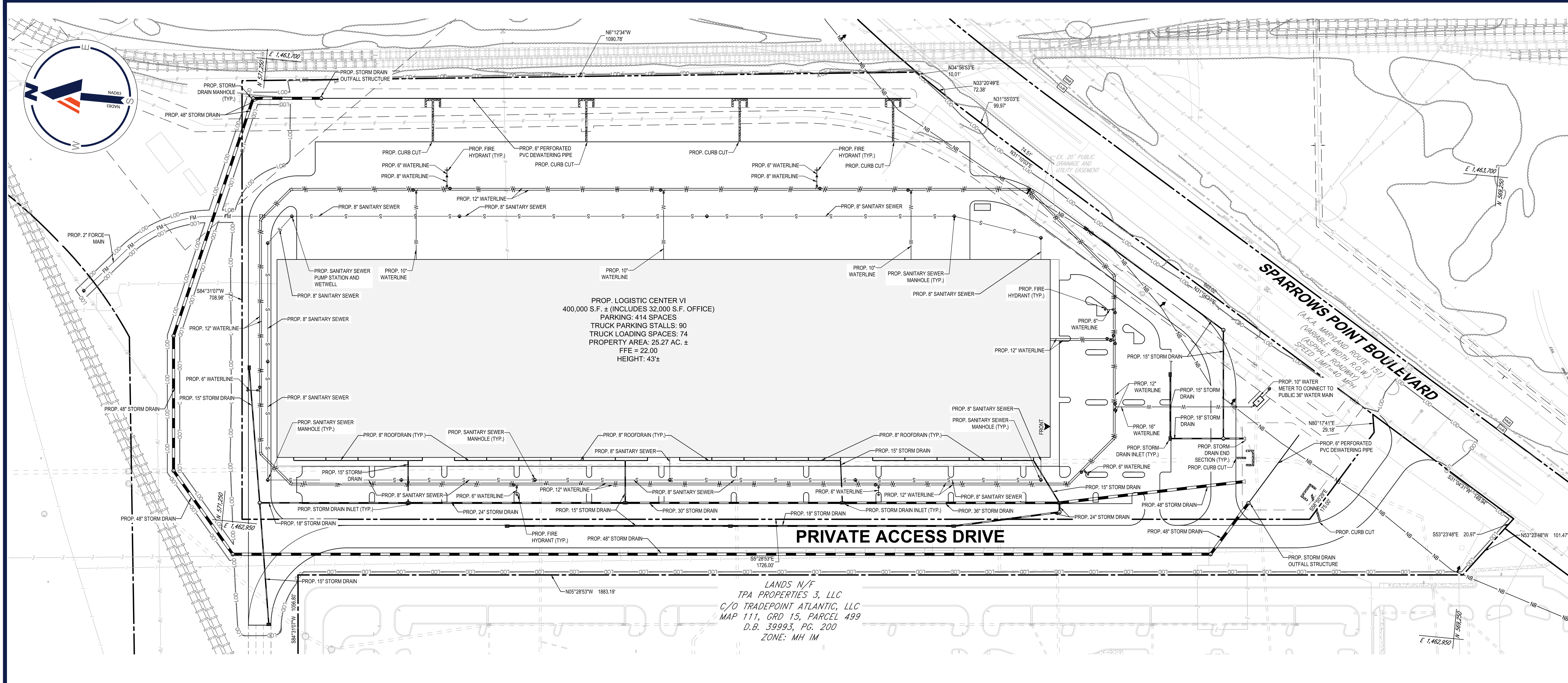

LEGEND

— W —	PROPOSED WATERLINE	— E —	EXISTING WATERLINE
— S —	PROPOSED SANITARY SEWER	— E —	EXISTING SANITARY SEWER
— FM —	PROPOSED FORCE MAIN	— E —	EXISTING FORCE MAIN
— SD —	PROPOSED STORM DRAIN	— E —	EXISTING STORM DRAIN
— FM —	PROPOSED FORCE MAIN	— E —	EXISTING FORCE MAIN

APPROXIMATE UTILITY DEPTHS NOTE

1. WATER - BETWEEN 4' AND 7' BELOW GRADE
2. STORM DRAIN - BETWEEN 2' AND 15' BELOW GRADE
3. SANITARY SEWER - BETWEEN 4' AND 8' BELOW GRADE
4. GAS, ELECTRIC, AND TELEPHONE - BETWEEN 2.5' AND 4' BELOW GRADE

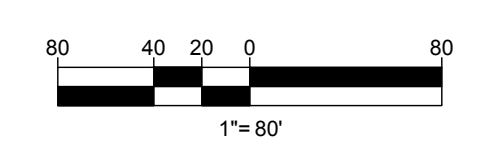

H:\16MD1620669\DRAWINGS\PLAN SETS\PRELIMINARY\PLANNING\16MD1620669-SSP-03-JAVOUT-03-UTILITY PLAN

BOHLER
 SITE CIVIL AND CONSULTING ENGINEERING
 PROGRAM MANAGEMENT
 LANDSCAPE ARCHITECTURE
 SUSTAINABLE DESIGN
 PERMITTING SERVICES
 TRANSPORTATION SERVICES

REVISIONS

REV	DATE	COMMENT	DRAWN BY

811
 Know what's below.
 Call before you dig.
 ALWAYS CALL 811
 It's fast. It's free. It's the law.

NOT APPROVED FOR CONSTRUCTION

THIS DRAWING IS INTENDED FOR MUNICIPAL AND/OR AGENCY REVIEW AND APPROVAL. IT IS NOT INTENDED AS A CONSTRUCTION DOCUMENT UNLESS INDICATED OTHERWISE.

PROJECT No.:	MD1620669
DRAWN BY:	ISL
CHECKED BY:	MJG
DATE:	03/06/2020
CAD I.D.:	SSP-0

PROJECT:
PROJECT VIPER
 FOR
TRADEPOINT ATLANTIC
 PRELIMINARY PLAN
 SPARROWS POINT BOULEVARD
 BALTIMORE, MD 21219
 TM 111, GRID 14, PARCEL 318
 ELECTION DISTRICT 15
 COUNCILMANIC DISTRICT 7
 BALTIMORE COUNTY

BOHLER
 901 DULANEY VALLEY ROAD, SUITE 801
 TOWSON, MARYLAND 21204
 Phone: (410) 821-7900
 Fax: (410) 821-7987
 MD@BohlerEng.com

M.J. GESELL
 PROFESSIONAL ENGINEER
 MARY AND LICENSE NO. 4457
 PROFESSIONAL CERTIFICATION
 I, MICHAEL J. GESELL, HEREBY CERTIFY THAT THESE DOCUMENTS WERE PREPARED OR APPROVED BY ME, AND THAT I AM A DULY LICENSED PROFESSIONAL ENGINEER UNDER THE LAWS OF THE STATE OF MARYLAND. LICENSE NO. 4457, EXPIRATION DATE: 6/30/21

SHEET TITLE:
UTILITY PLAN
 SHEET NUMBER:
3
 ORG. DATE - 03/06/2020

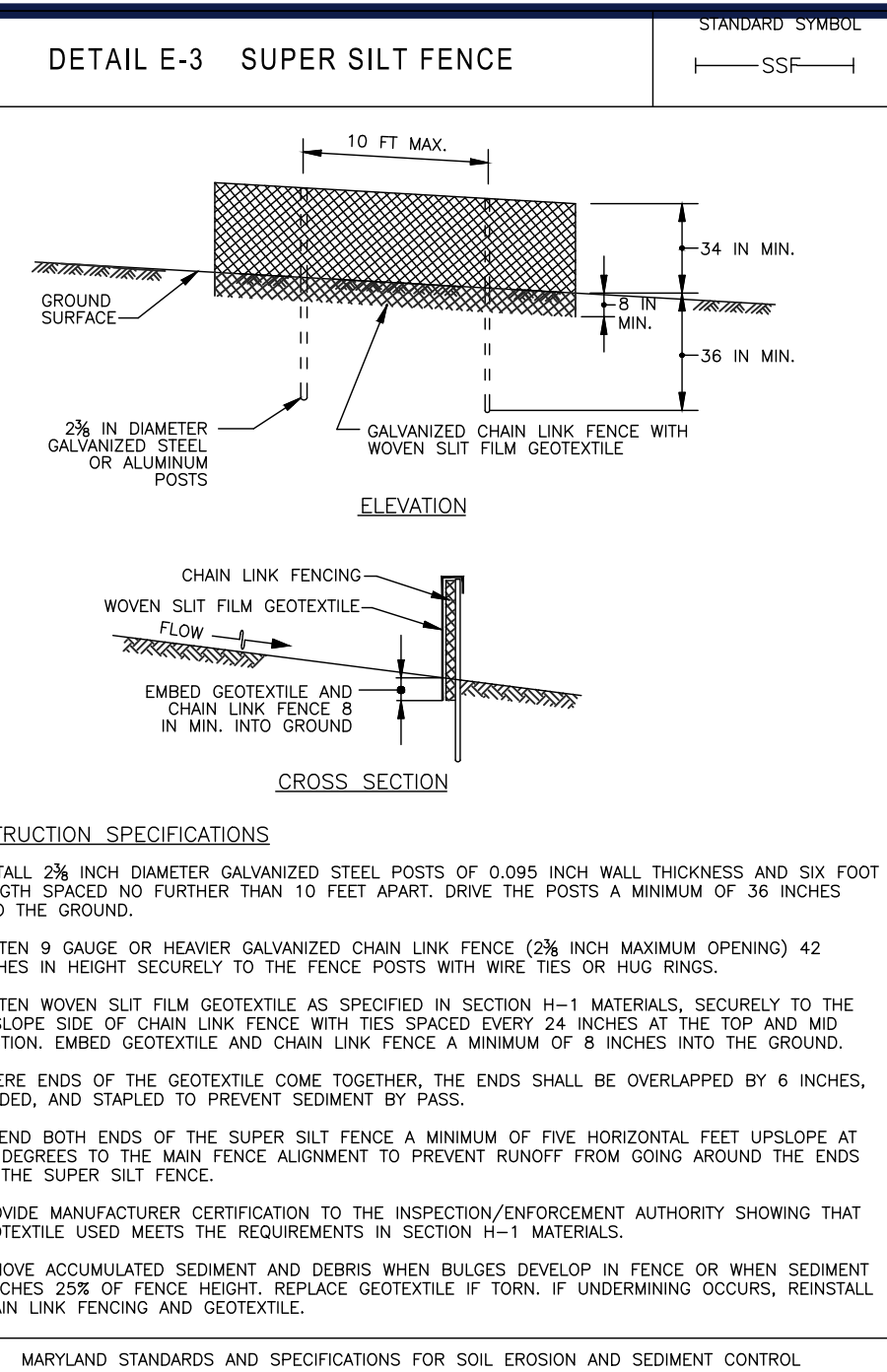
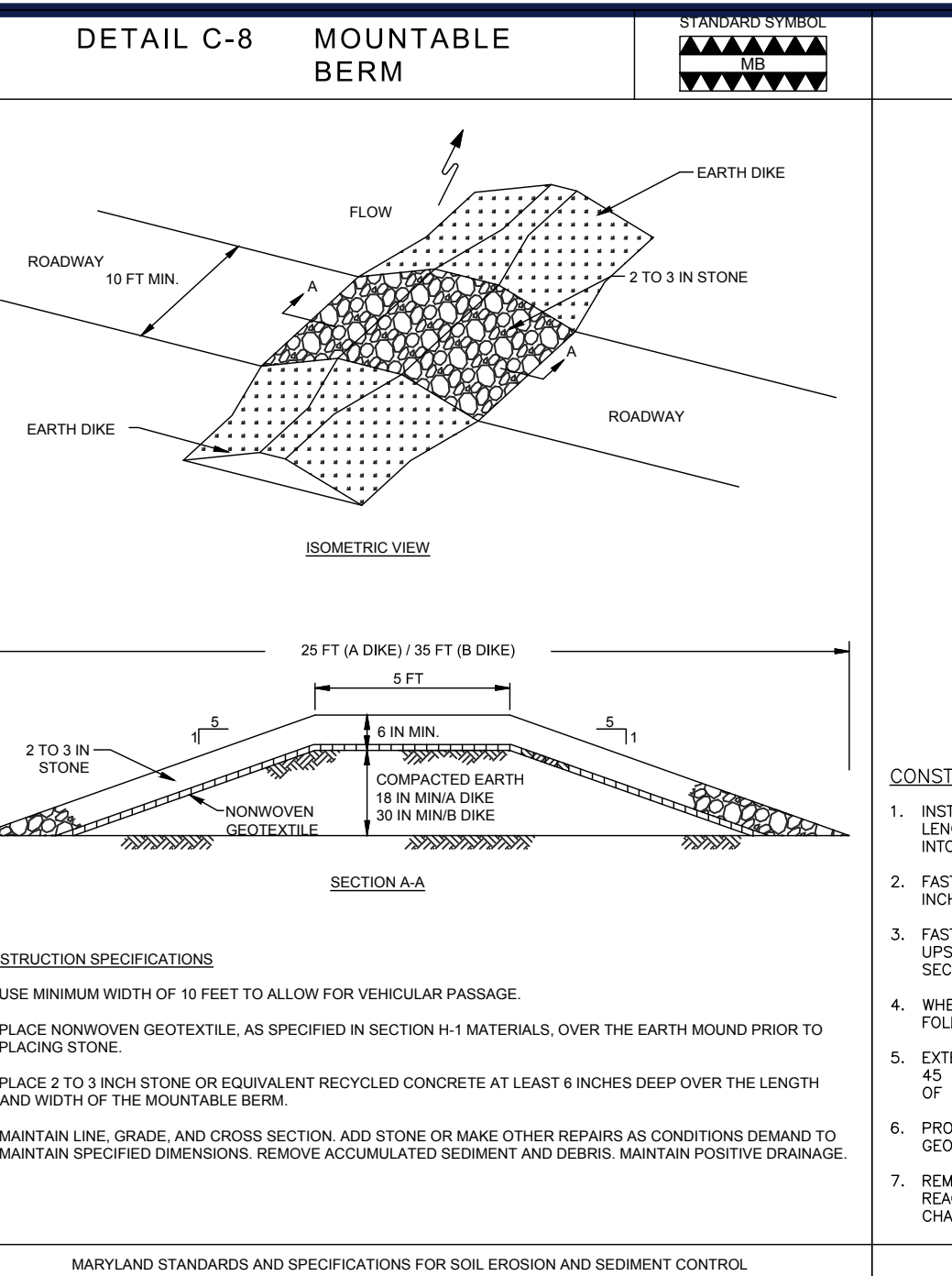
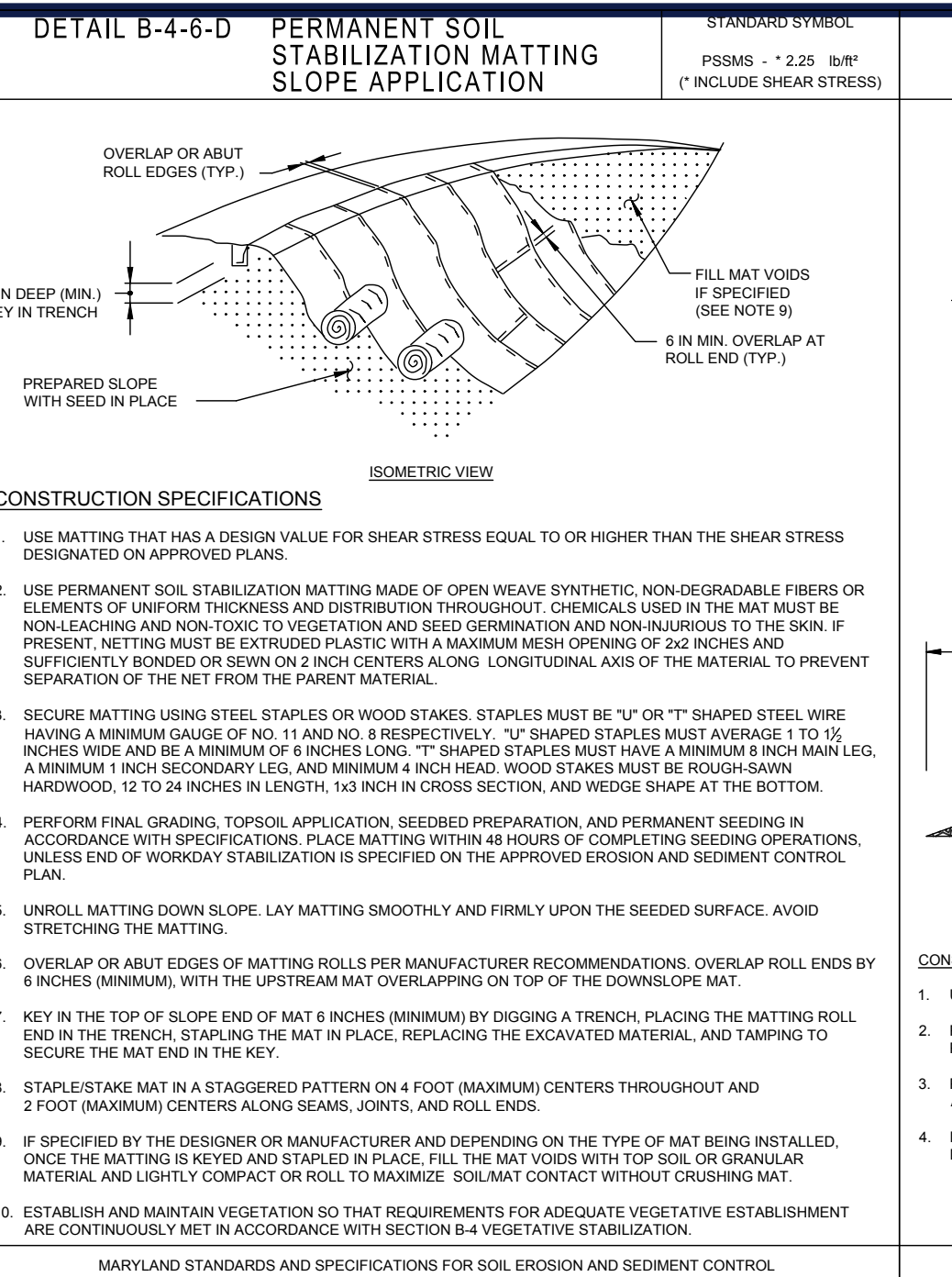
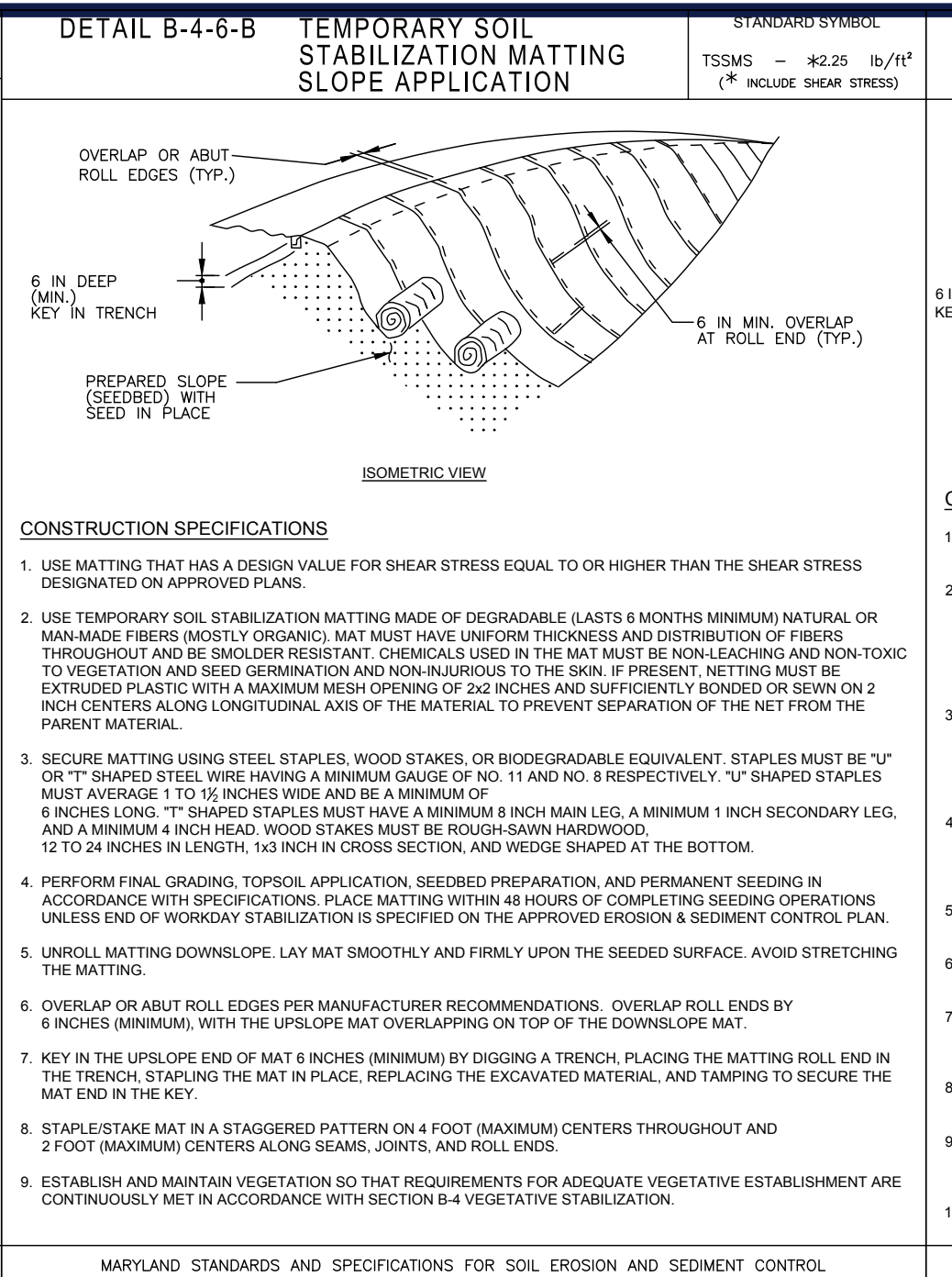
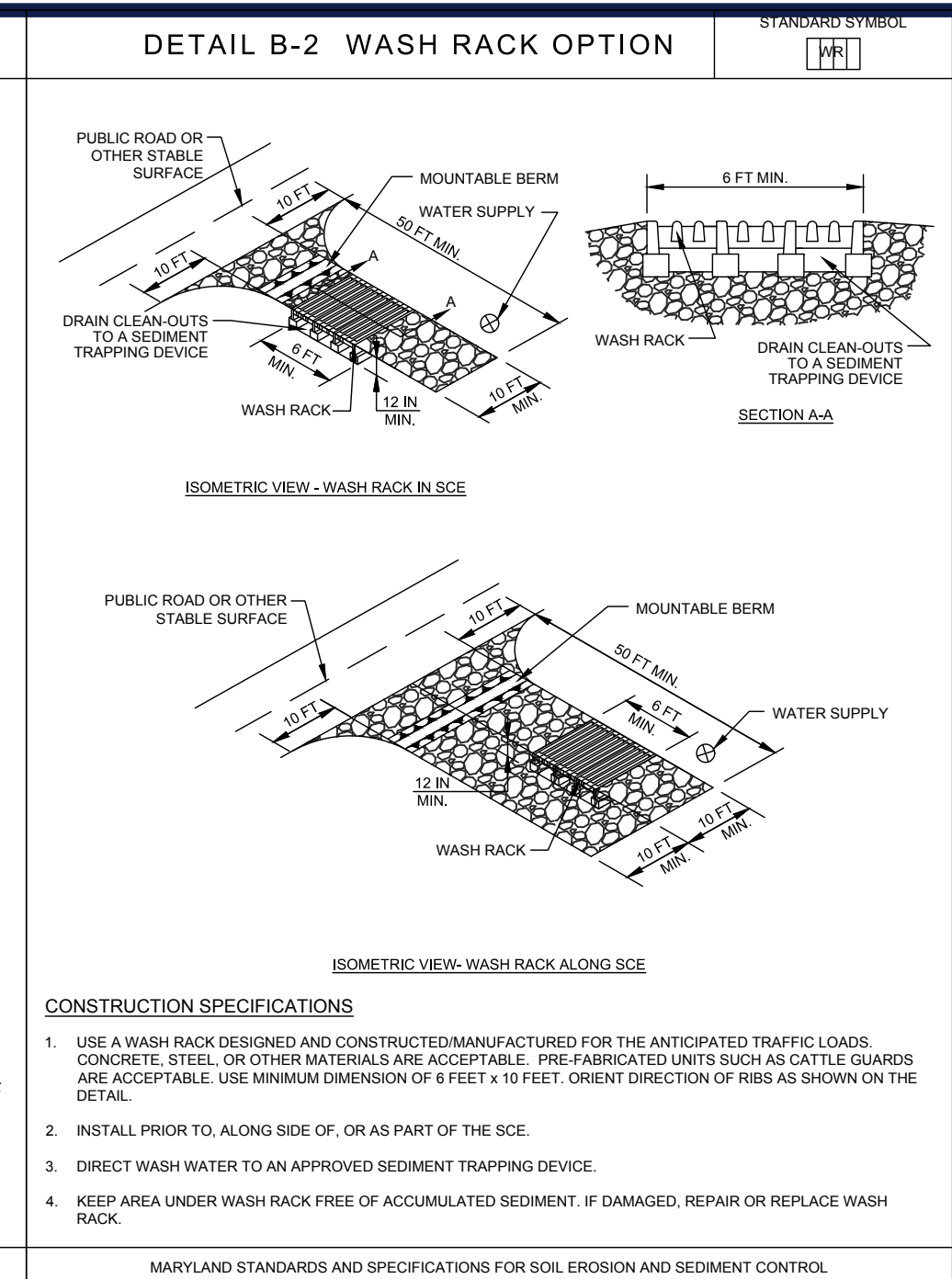
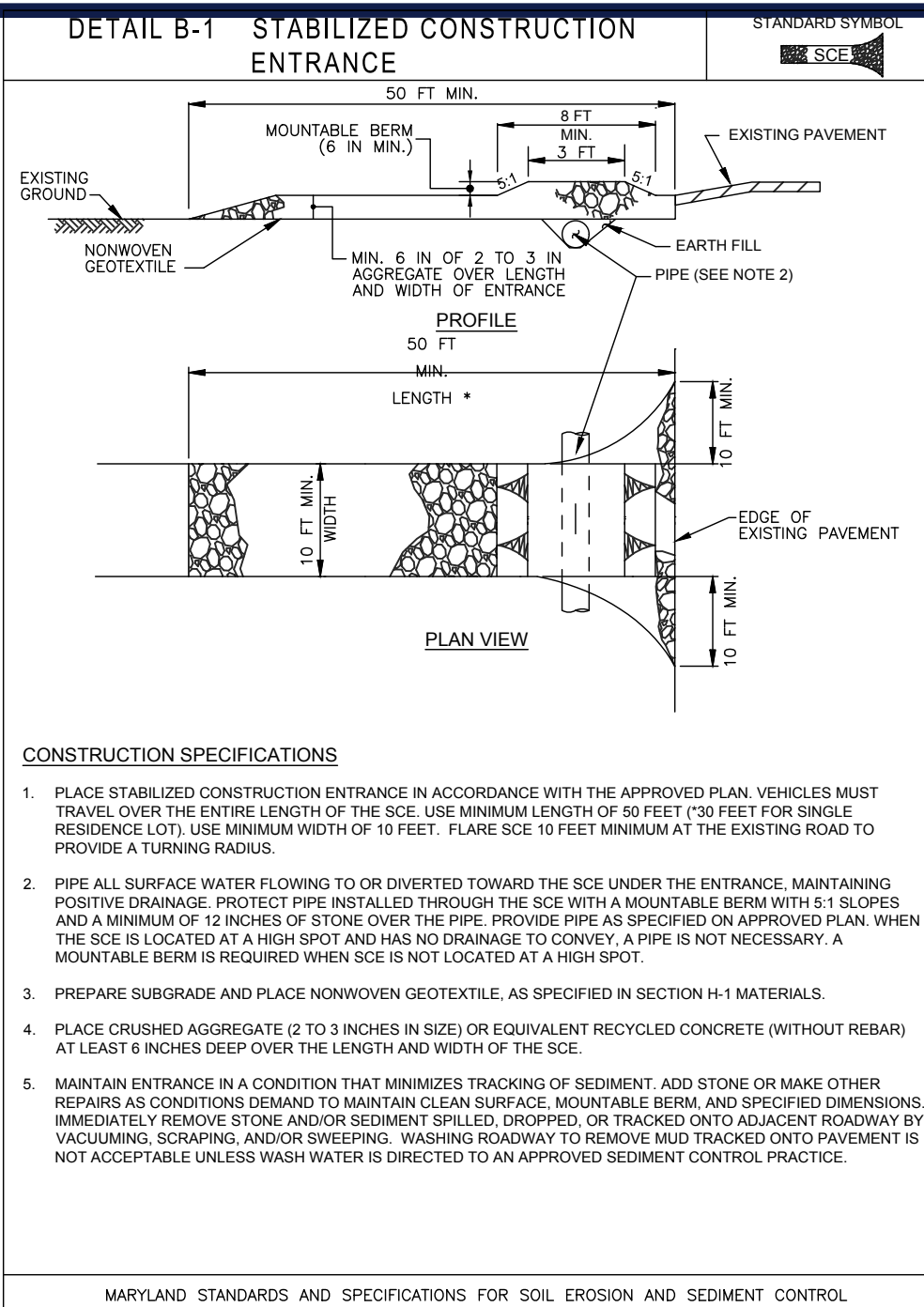

MARYLAND STANDARDS AND SPECIFICATIONS FOR SOIL EROSION AND SEDIMENT CONTROL

MARYLAND STANDARDS AND SPECIFICATIONS FOR SOIL EROSION AND SEDIMENT CONTROL

MARYLAND STANDARDS AND SPECIFICATIONS FOR SOIL EROSION AND SEDIMENT CONTROL

MARYLAND STANDARDS AND SPECIFICATIONS FOR SOIL EROSION AND SEDIMENT CONTROL

MARYLAND STANDARDS AND SPECIFICATIONS FOR SOIL EROSION AND SEDIMENT CONTROL

MARYLAND STANDARDS AND SPECIFICATIONS FOR SOIL EROSION AND SEDIMENT CONTROL

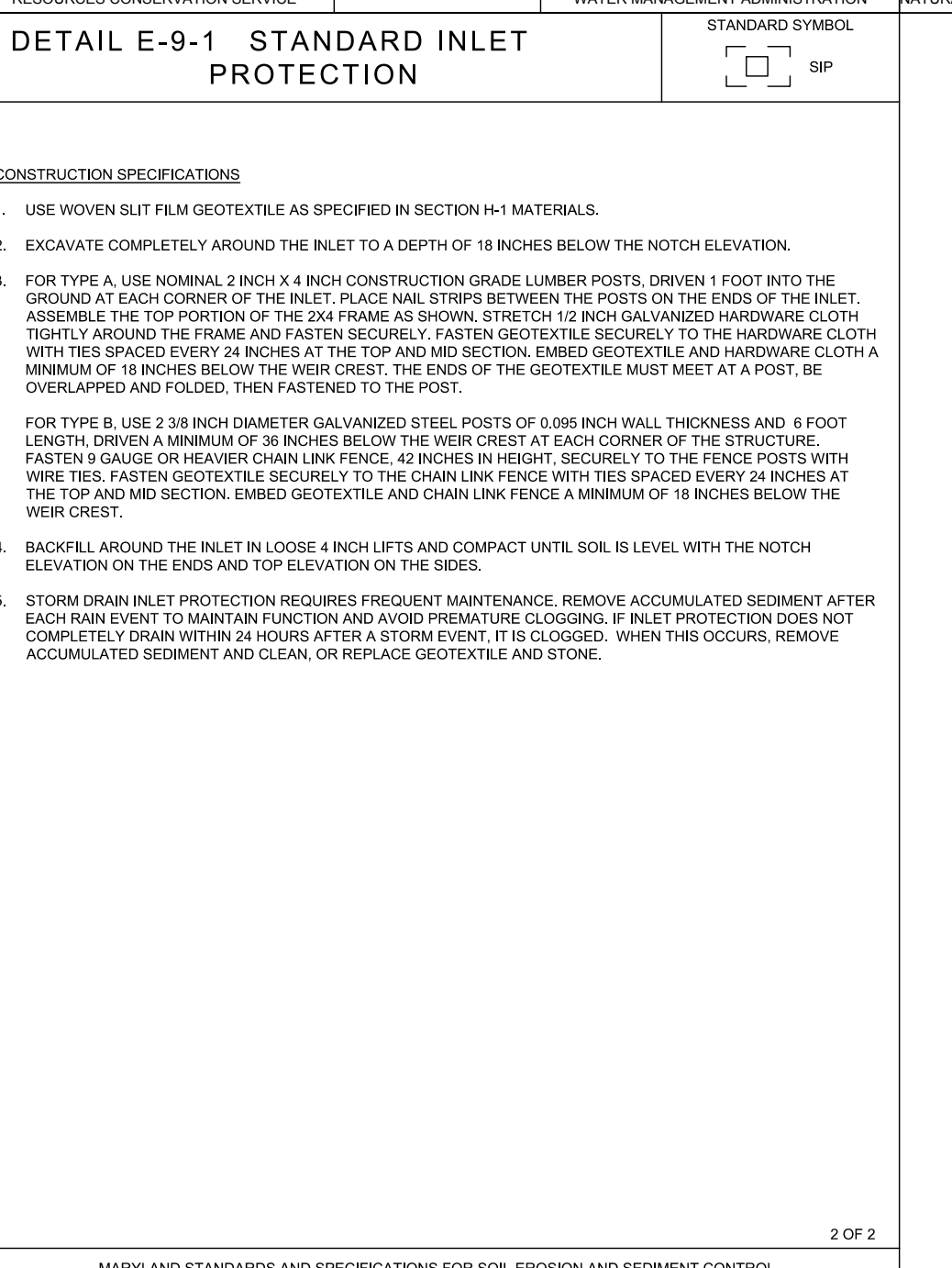
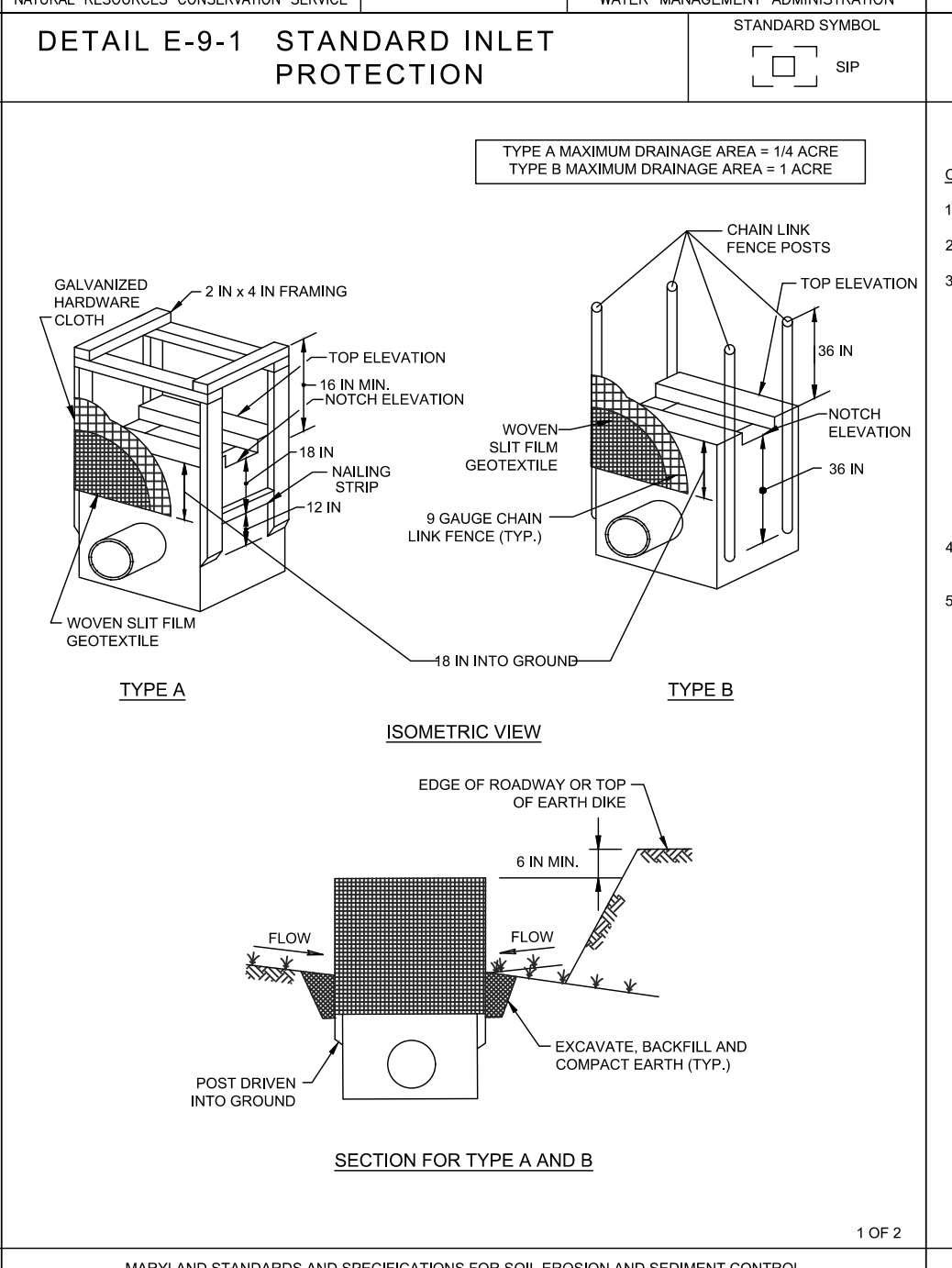
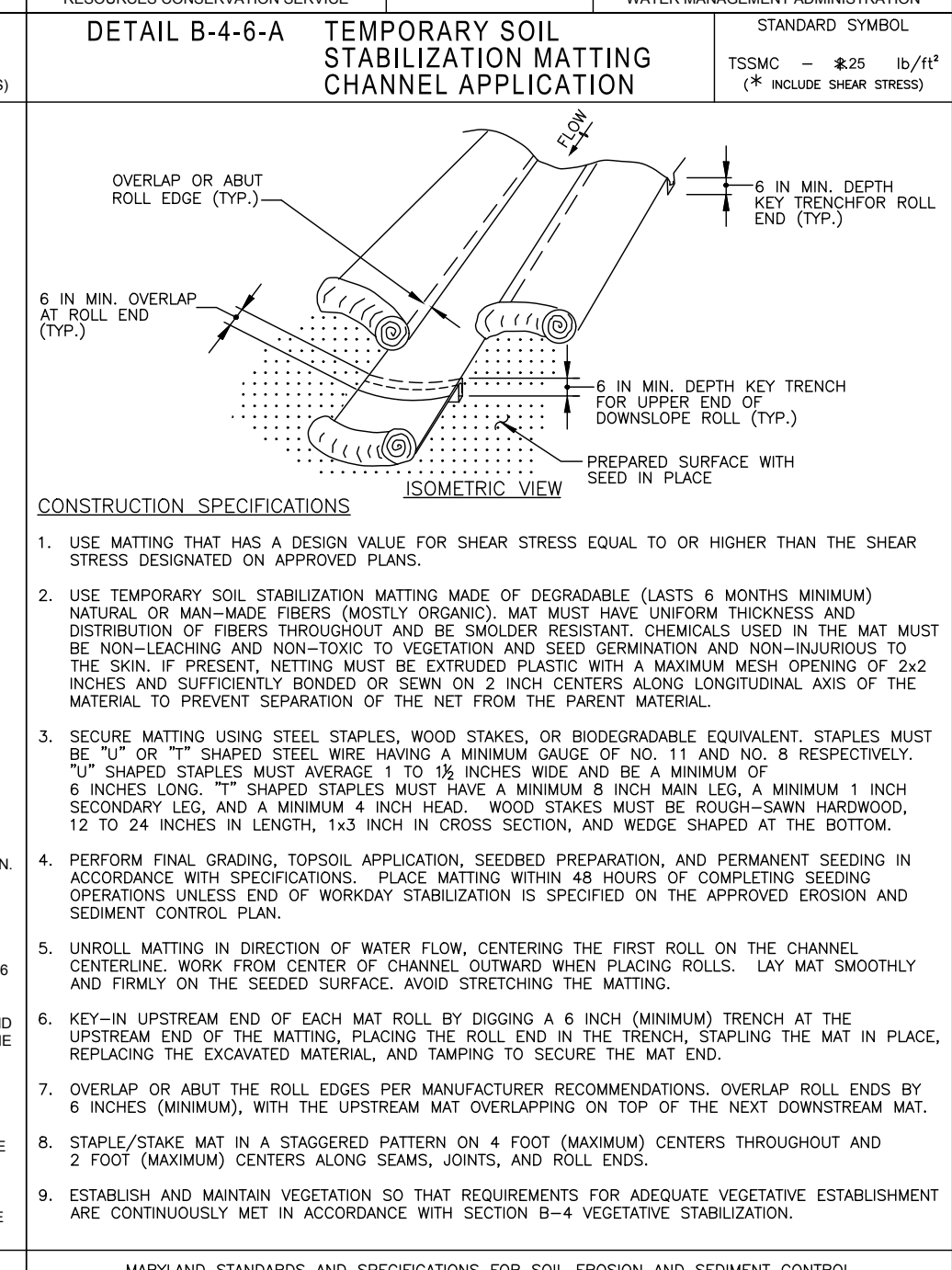
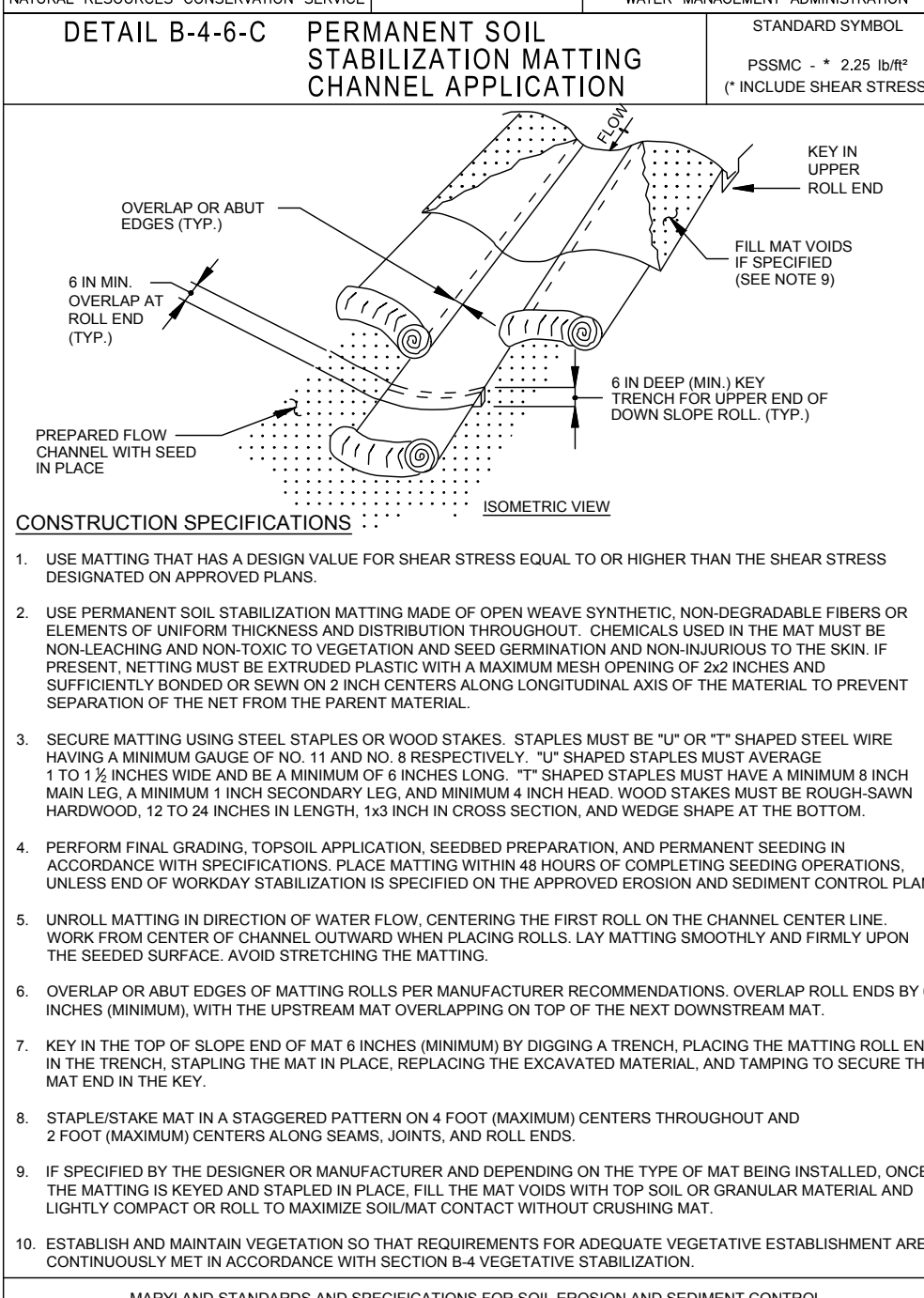

MARYLAND STANDARDS AND SPECIFICATIONS FOR SOIL EROSION AND SEDIMENT CONTROL

MARYLAND STANDARDS AND SPECIFICATIONS FOR SOIL EROSION AND SEDIMENT CONTROL

MARYLAND STANDARDS AND SPECIFICATIONS FOR SOIL EROSION AND SEDIMENT CONTROL

MARYLAND STANDARDS AND SPECIFICATIONS FOR SOIL EROSION AND SEDIMENT CONTROL

MARYLAND STANDARDS AND SPECIFICATIONS FOR SOIL EROSION AND SEDIMENT CONTROL

MARYLAND STANDARDS AND SPECIFICATIONS FOR SOIL EROSION AND SEDIMENT CONTROL

REVISIONS			
REV	DATE	COMMENT	DRAWN BY

NOT APPROVED FOR CONSTRUCTION

THIS DRAWING IS INTENDED FOR MUNICIPAL AND/OR AGENCY REVIEW AND APPROVAL. IT IS NOT INTENDED AS A CONSTRUCTION DOCUMENT UNLESS INDICATED OTHERWISE.

PROJECT No.: MD1620669
 DRAWN BY: ISL
 CHECKED BY: MUG
 DATE: 03/06/2020
 CAD ID: S509

PROJECT VIPER

FOR

PRELIMINARY PLAN

SPARROWS POINT BOULEVARD
 BALTIMORE, MD 21219
 TM 111, GRID 14, PARCEL 318
 ELECTION DISTRICT 15
 COUNCILMANIC DISTRICT 7
 BALTIMORE COUNTY

901 DULANEY VALLEY ROAD, SUITE 801
 TOWSON, MARYLAND 21284
 Phone: (410) 821-7900
 Fax: (410) 821-7987
 MD@BohlerEng.com

M.J. GESELL

PROFESSIONAL ENGINEER

I, MICHAEL J. GESELL, HEREBY CERTIFY THAT THESE DOCUMENTS WERE PREPARED OR APPROVED BY ME, AND THAT I AM A DULY LICENSED PROFESSIONAL ENGINEER UNDER THE LAWS OF THE STATE OF MARYLAND, LICENSE NO. 44097, EXPIRATION DATE: 6/30/21

SHEET TITLE:

SECTIONS AND DETAILS

SHEET NUMBER:

4

ORG. DATE - 03/06/2020

H:\1620669\DRAWINGS\PLAN SETS\PRELIMINARY\PLANNING\1620669-SSP-03-01-04-SECTION AND DETAILS

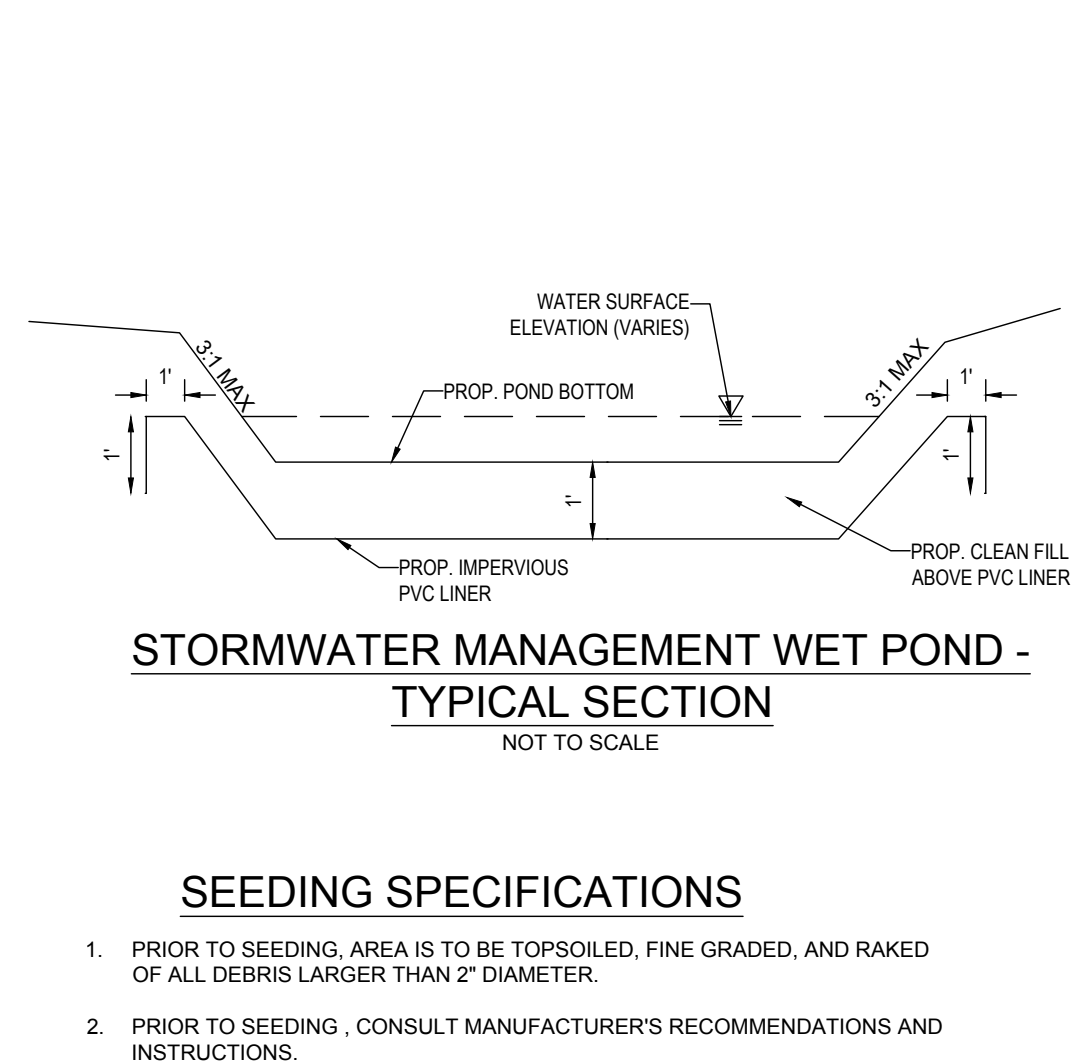
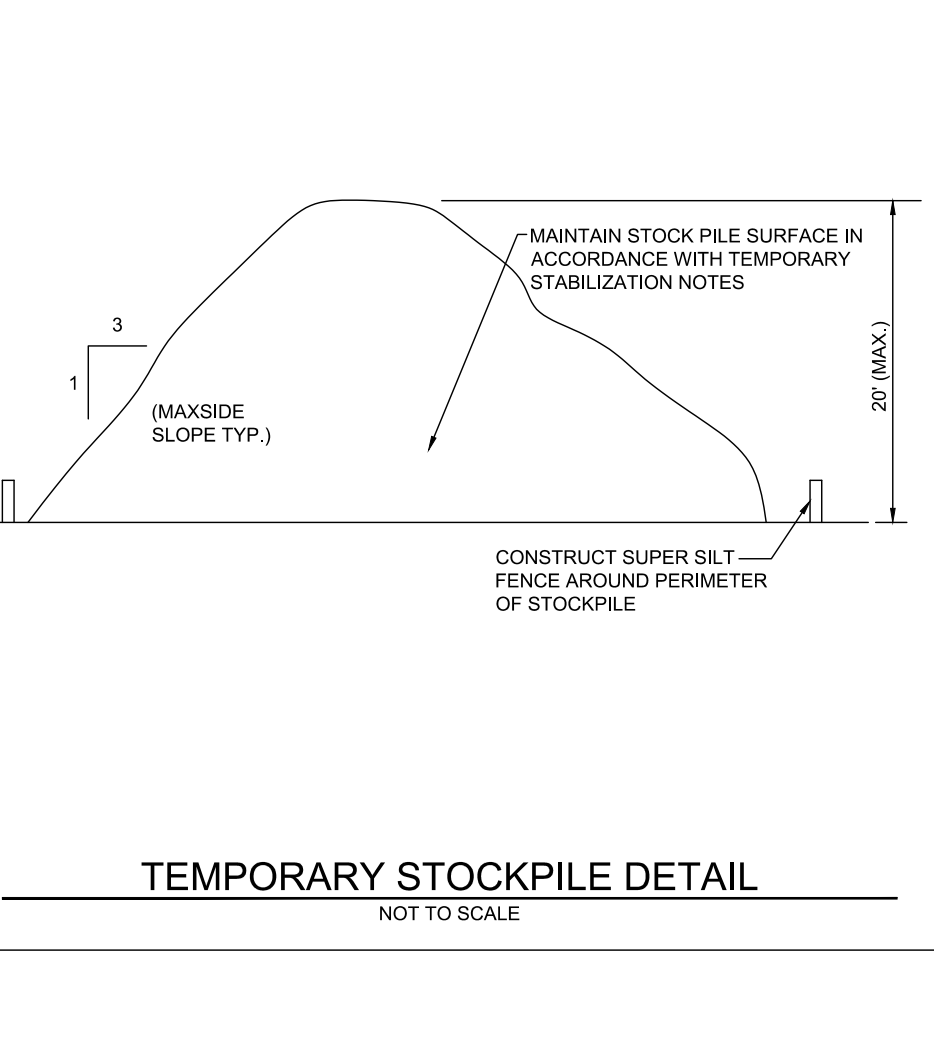
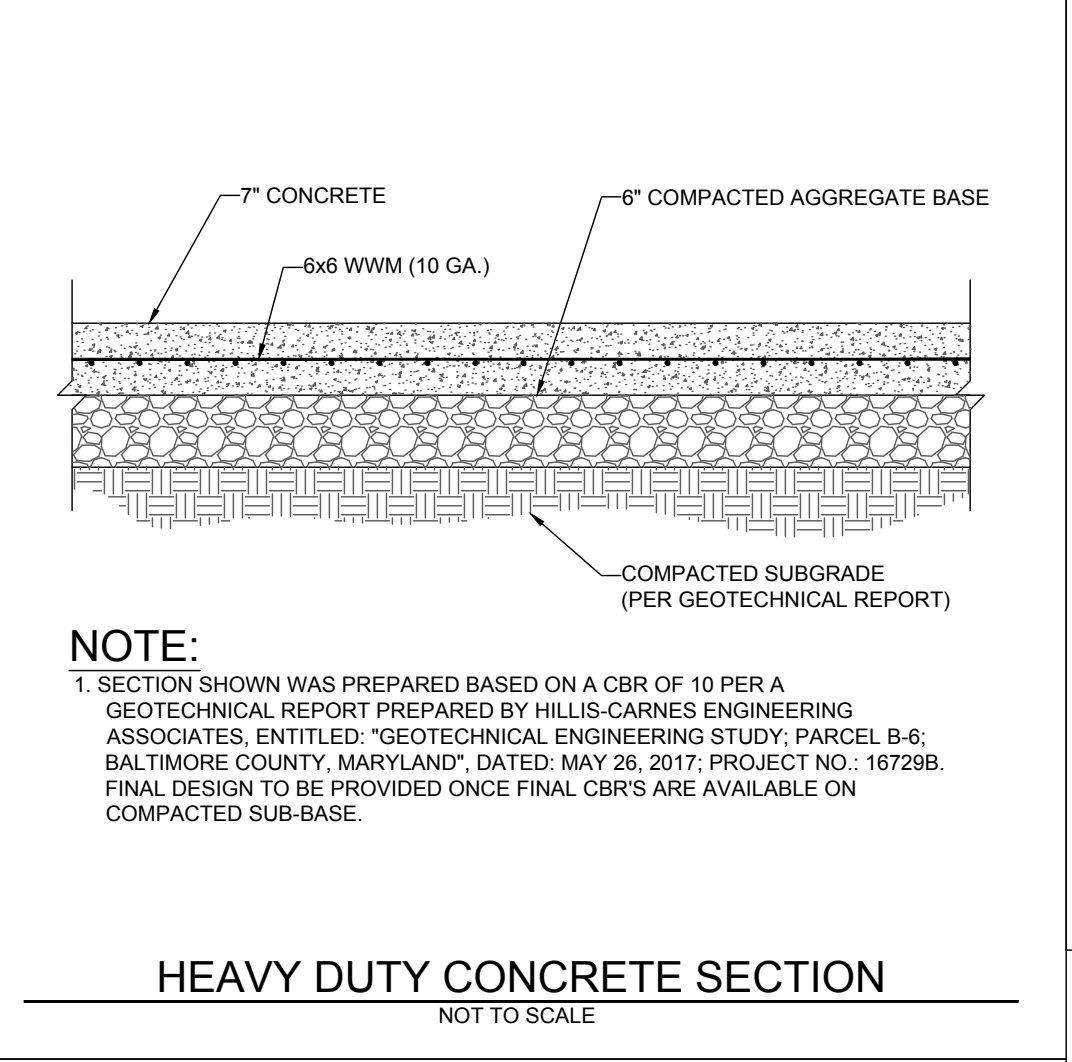
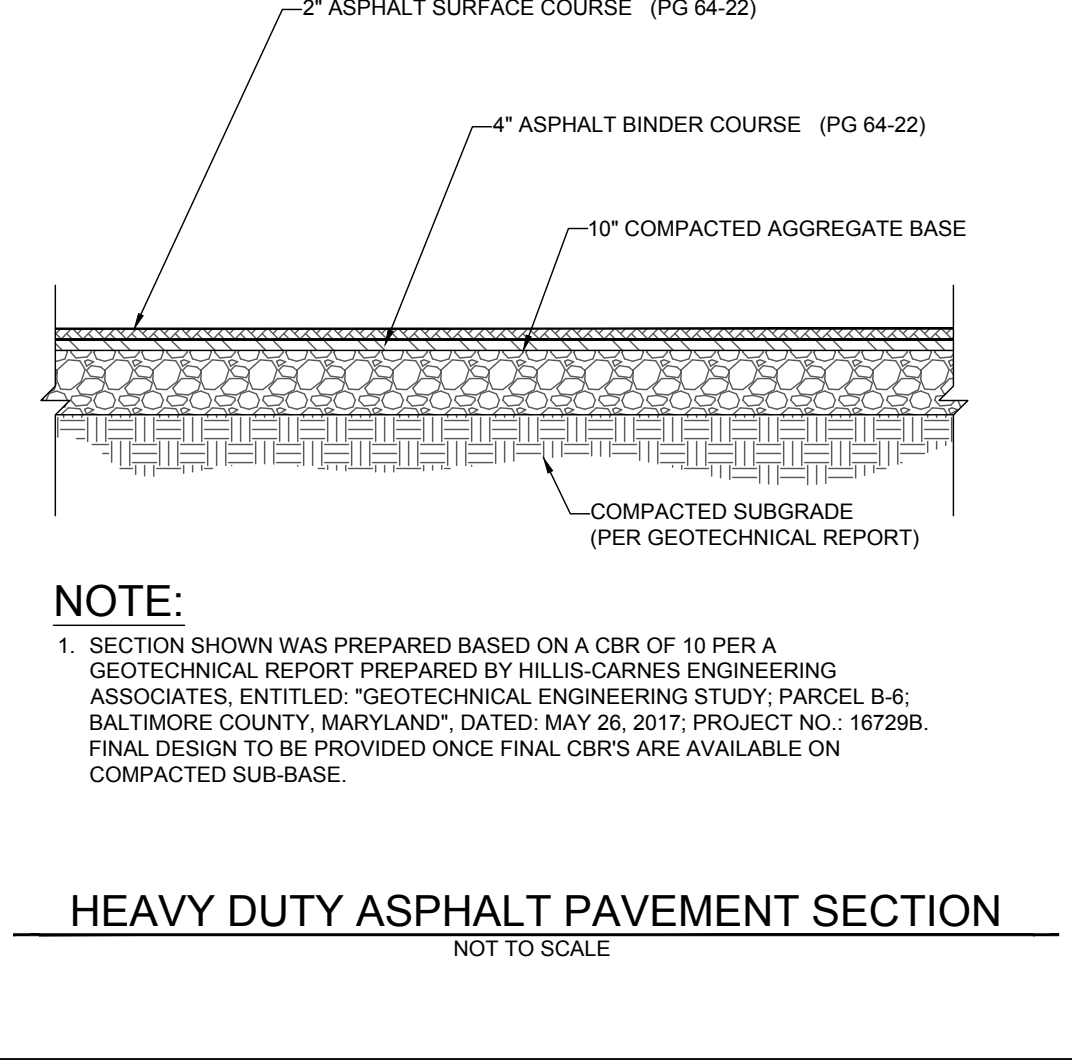
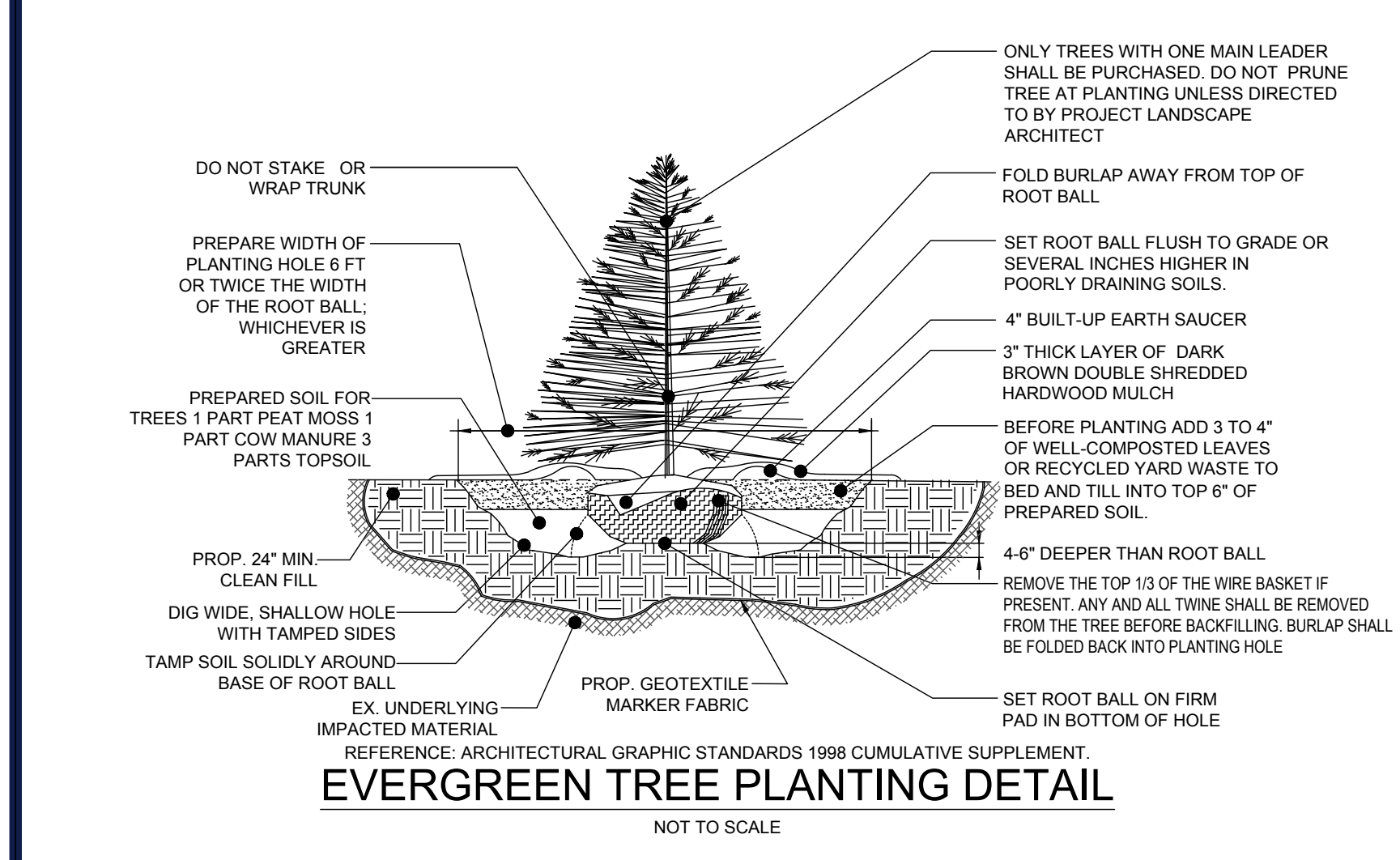
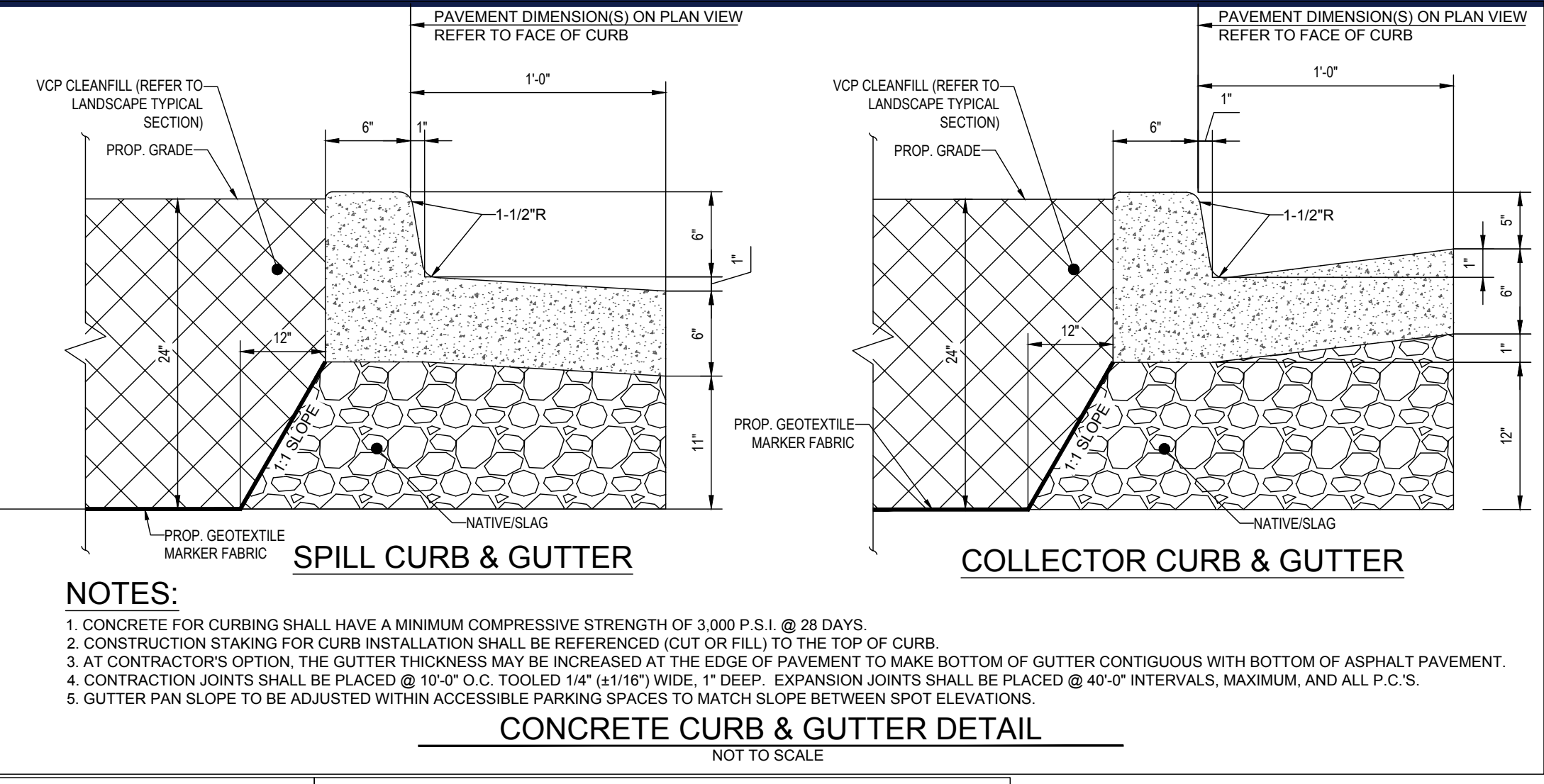
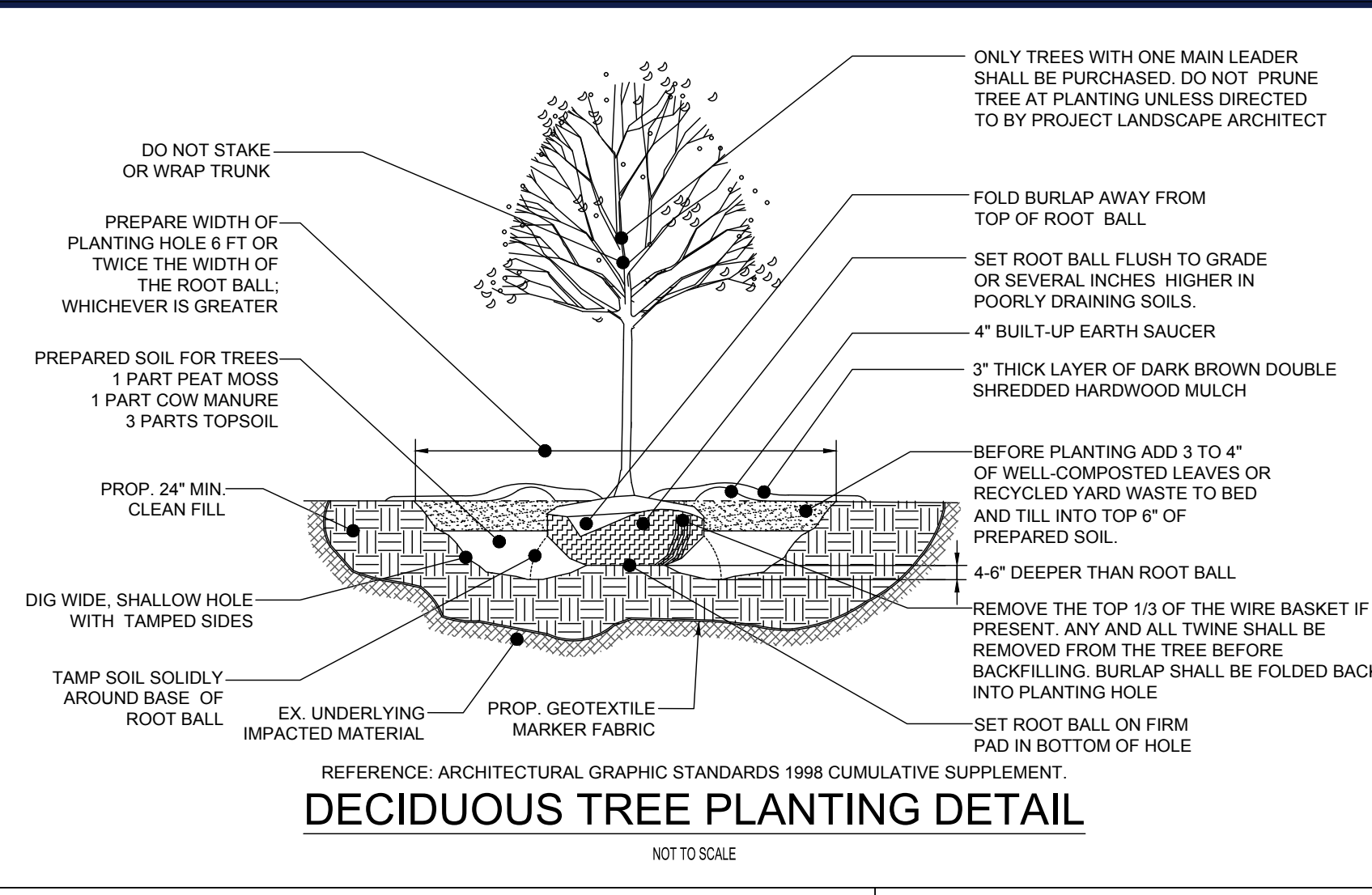
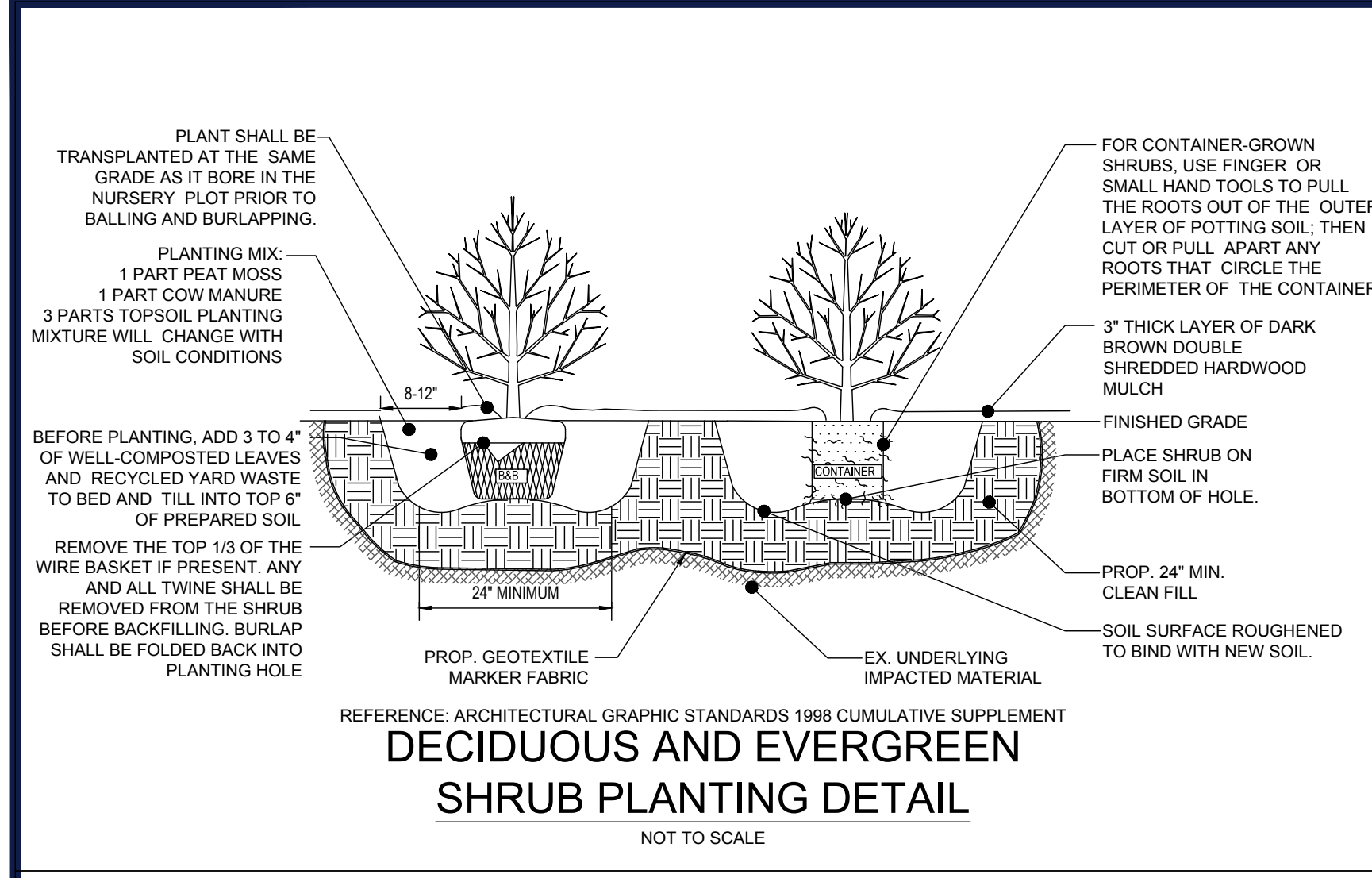

SEQUENCE OF CONSTRUCTION:

- NOTIFY BALTIMORE COUNTY DEPARTMENT OF PERMITS, APPROVALS, AND INSPECTIONS, SEDIMENT CONTROL (410-887-3226) AT LEAST 48 HOURS PRIOR TO BEGINNING WORK ON SITE. HIGH VISIBILITY ORANGE SAFETY FENCE SHALL BE MANUALLY INSTALLED ALONG THE LIMIT OF DISTURBANCE (LOD) WHEREVER THE LOD IS WITHIN 50 FEET OF ANY FOREST BUFFER OR FOREST CONSERVATION EASEMENT. THIS FENCE SHALL BE INSPECTED BY DEPS AT THE PRECONSTRUCTION MEETING.
- STAKE OVERALL LIMIT OF DISTURBANCE PER THE APPROVED EROSION AND SEDIMENT CONTROL PLANS. INSTALL SAFETY FENCE AS NECESSARY.
- CLEAR, GRUB AND REMOVE ANY NECESSARY EXISTING FEATURES INTERFERING WITH PERIMETER SEDIMENT AND EROSION CONTROL MEASURES AND DEVICES ONLY, INCLUDING RAILROAD TRACKS AS NECESSARY. INSTALL STABILIZED CONSTRUCTION ENTRANCE WITH MOUNTABLE BERM, SUPER SILT FENCE, AND CONCRETE WASHOUT STATION AS DIRECTED BY THE BALTIMORE COUNTY SEDIMENT CONTROL INSPECTOR AS SHOWN ON PLAN. SUPER SILT FENCE SHALL BE INSPECTED & MAINTAINED EACH DAY AND AFTER EACH STORM EVENT. MAINTENANCE SHALL INCLUDE BUT NOT BE LIMITED TO REMOVAL OF ALL ACCUMULATED SEDIMENT. GEOTEXTILE FABRIC SHALL BE REPLACED AS NEEDED TO ENSURE PROPER FUNCTION.
- WITH THE APPROVAL OF BALTIMORE COUNTY DEPARTMENT OF PERMITS, APPROVALS, AND INSPECTIONS, SEDIMENT CONTROL AND THE SEDIMENT CONTROL INSPECTOR, CLEAR AND GRUB REMAINDER OF THE SITE. REMOVE REMAINDER OF PAVING, CURB, PORTIONS OF THE BUILDING SLAB, NECESSARY UTILITIES, ETC. AS SHOWN ON THE DEMOLITION PLANS. ALL OPEN PIPE ENDS TO BE BLOCKED DAILY TO PREVENT SEDIMENT FROM ENTERING THE STORMDRAIN SYSTEM. ALL AREAS OUTSIDE OF THE PERIMETER CONTROL MEASURES SHALL BE COMPLETED PER THE "WORK OUTSIDE PERIMETER CONTROLS NOTES" AND "UTILITY NOTES ON THE APPROVED SEDIMENT CONTROL PLANS". DISPOSAL MATERIAL WILL EITHER NEED TO BE TAKEN TO A RUBBLE LANDFILL WITH AN ACTIVE GRADING PERMIT AND APPROVED SEDIMENT CONTROL PLAN, OR AN EXISTING ASPHALT RECYCLING FACILITY SUBJECT TO THE SAME.
- IMMEDIATELY AFTER DEMOLITION ACTIVITIES HAVE OCCURRED, BEGIN SITE GRADING.
- BEGIN INSTALLATION OF STORM DRAIN STRUCTURES ALONG WITH ASSOCIATES STORM DRAIN PIPES. IMMEDIATELY INSTALL INLET PROTECTION ON PROPOSED INLETS AS SHOWN ON THE APPROVED SEDIMENT CONTROL PLANS. CONTRACTOR SHALL PERFORM SUFFICIENT GRADING SURROUNDING INLETS, TO ENSURE THAT IT IS CAPABLE OF FUNCTIONING AND CAPTURING ALL UPSLOPE FLOWS.
- ONCE SUBGRADES ARE REACHED, BEGIN CONSTRUCTION OF WAREHOUSE AND CONCRETE CURB AND GUTTER. BEGIN CONSTRUCTION OF UNDERGROUND UTILITIES. GRADES AROUND THE BUILDING SHOULD BE DESIGNED SUCH THAT ALL RUNOFF WILL FLOW AROUND THE BUILDING.
- COMPLETE FINE GRADING OF SITE. SITE SHALL BE BROUGHT TO GRADE AS SOON AS POSSIBLE AND STABILIZED WITH EITHER STONE SUBBASE OR PERMANENT SEED AND MULCH. EXCAVATE FOR STORMWATER MANAGEMENT AREAS.
- INSTALL ANY REMAINING STONE SUBBASE AND BEGIN PAVING.

UPON STABILIZATION OF THE CONTRIBUTING DRAINAGE AREA WITH ESTABLISHED VEGETATION AND WITH PERMISSION FROM THE SEDIMENT CONTROL INSPECTOR, INSTALL STORMWATER MANAGEMENT PONDS AS WELL AS INSTALL LANDSCAPING ON THE REST OF THE SITE PER THE APPROVED LANDSCAPING PLAN.

- UPON STABILIZATION OF THE SITE WITH ESTABLISHED VEGETATION AND WITH PERMISSION FROM THE SEDIMENT CONTROL INSPECTOR, REMOVE SEDIMENT CONTROL MEASURES AND STABILIZE THOSE AREAS DISTURBED BY THIS PROCESS.

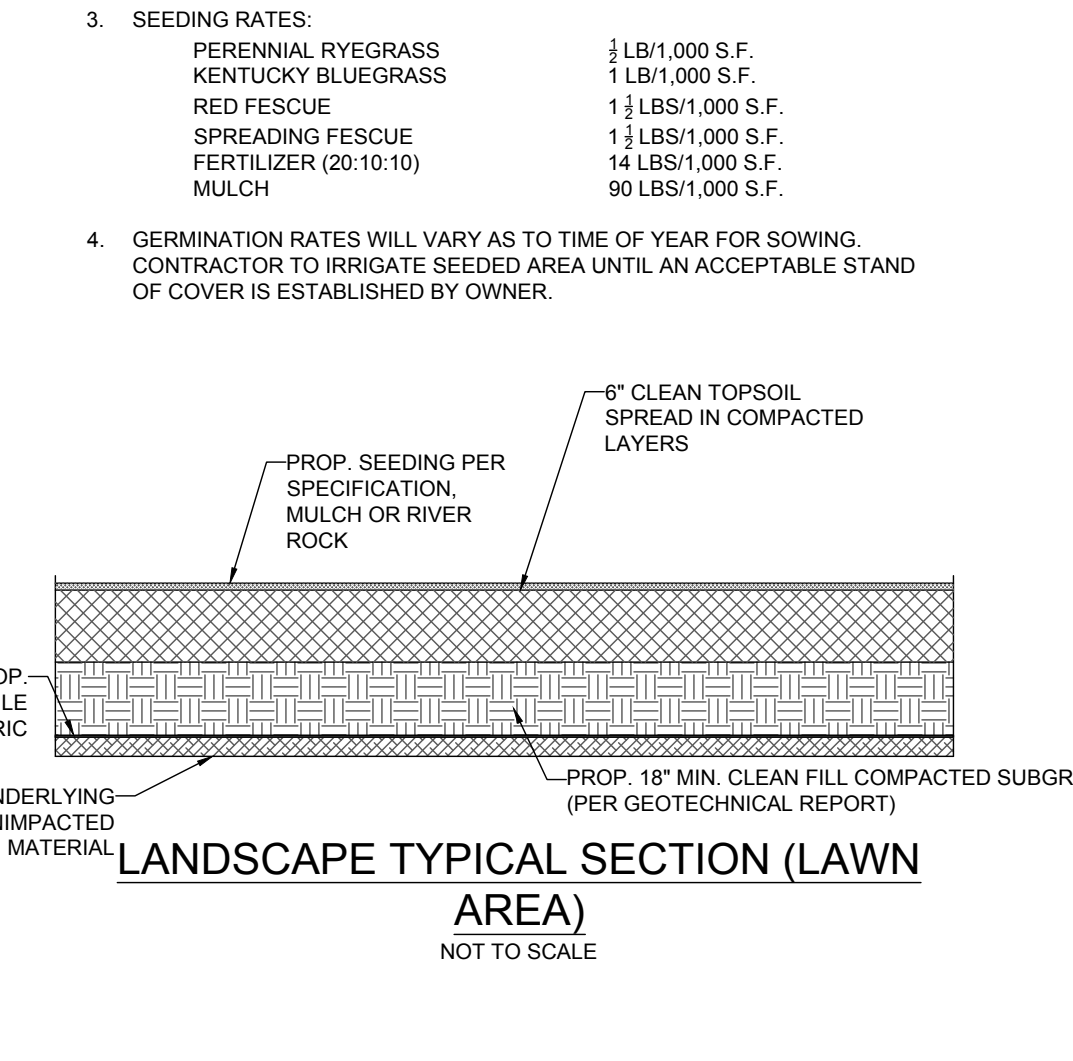
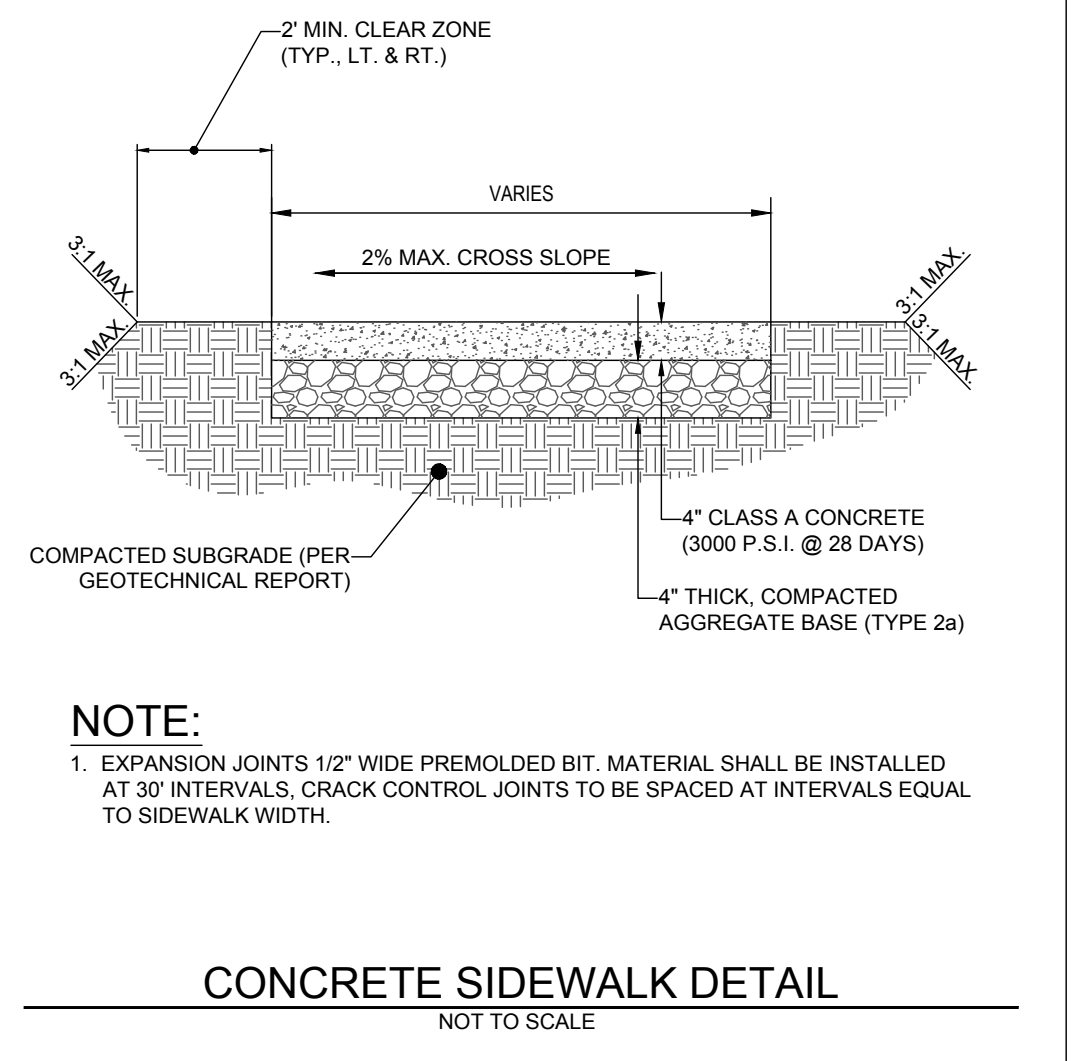
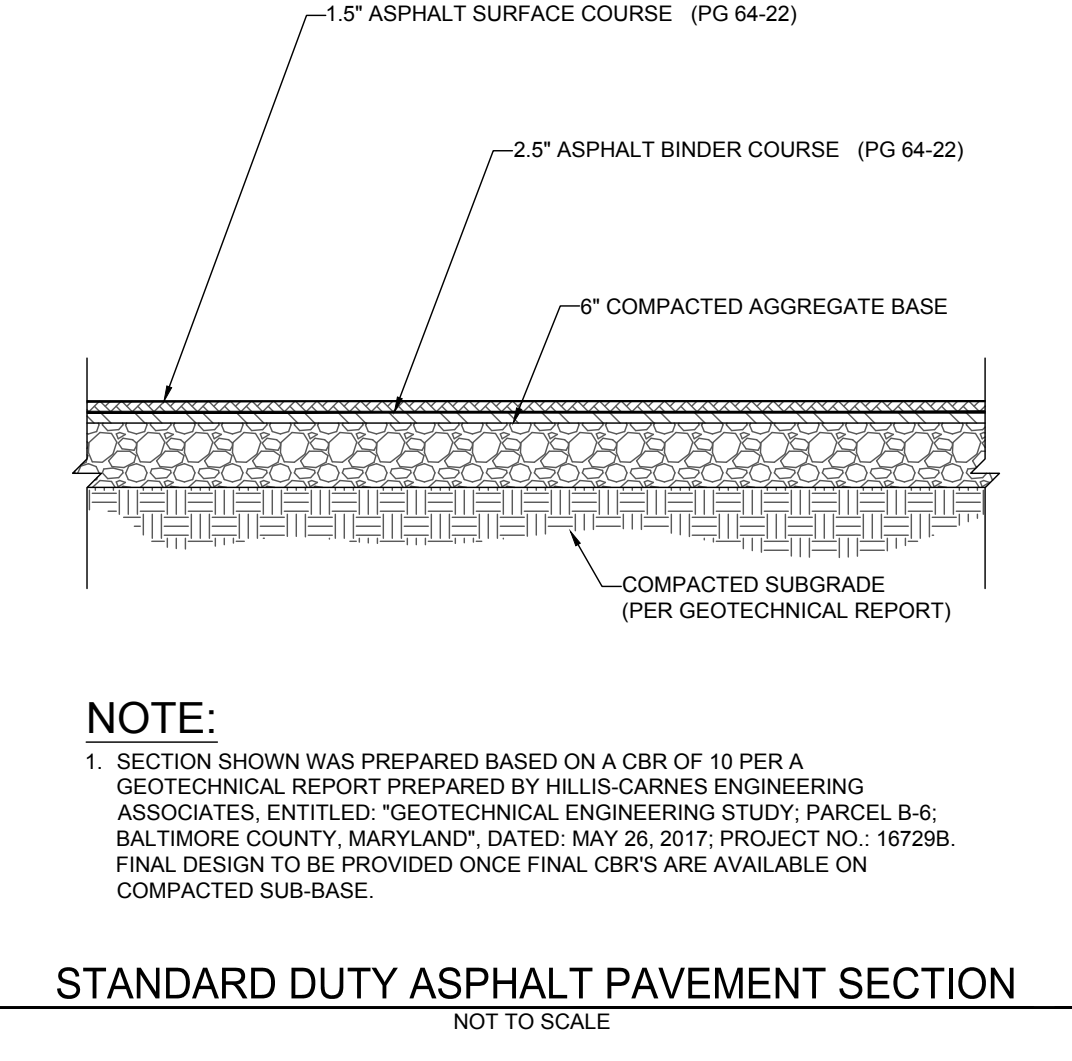

11/16/2016 09:00 AM DRAWINGS/PLAN SETS/PRELIMINARY PLANNING/MD1620669-SSP-0-0-0-JAYOUT-05-SECTIONS AND DETAILS

BOHLER
 SITE CIVIL AND CONSULTING ENGINEERING
 PROGRAM MANAGEMENT
 LANDSCAPE ARCHITECTURE
 SUSTAINABLE DESIGN
 PERMITTING SERVICES
 TRANSPORTATION SERVICES

REVISIONS

REV	DATE	COMMENT	DRAWN BY	CHECKED BY

811
 Know what's below.
 Call before you dig.
 ALWAYS CALL 811
 It's fast. It's free. It's the law.

NOT APPROVED FOR CONSTRUCTION

PROJECT: MD1620669

DRAWN BY:	ISL
CHECKED BY:	MUG
DATE:	03/06/2020
CAD ID:	SSP-0

PROJECT VIPER

FOR

TRADEPOINT ATLANTIC

PRELIMINARY PLAN

SPARROWS POINT BOULEVARD
 BALTIMORE, MD 21219
 TM 111, GRID 14, PARCEL 318
 ELECTION DISTRICT 15
 COUNCILMANIC DISTRICT 7
 BALTIMORE COUNTY

BOHLER

901 DULANEY VALLEY ROAD, SUITE 801
 TOWSON, MARYLAND 21284
 Phone: (410) 821-7900
 Fax: (410) 821-7987
 MD@BohlerEng.com

M.J. GESELL

PROFESSIONAL ENGINEER
 PROFESSIONAL CERTIFICATION
 I, MICHAEL J. GESELL, HEREBY CERTIFY THAT THESE DOCUMENTS WERE PREPARED OR APPROVED BY ME, AND THAT I AM A DULY LICENSED PROFESSIONAL ENGINEER UNDER THE LAWS OF THE STATE OF MARYLAND, LICENSE NO. 44097, EXPIRATION DATE: 6/30/21

SHEET TITLE:
SECTIONS AND DETAILS

SHEET NUMBER:
5

ORG. DATE - 03/06/2020

SITE SPECIFIC STRIPING NOTES

1. ALL STRIPING WILL BE TWO (2) COATS OF 6 MILS DRY THICKNESS, EACH COAT.
2. ALL PAVEMENT STRIPING ON CONCRETE PAVEMENT WILL BE YELLOW UNLESS OTHERWISE NOTED.
3. ALL PAVEMENT STRIPING ON ASPHALT PAVEMENT WILL BE WHITE, UNLESS OTHERWISE NOTED. STRIPING WITHIN TRAILER PARKING TO REMAIN WHITE ACROSS CONCRETE DOLLY STRIP.

SHA NOTE

ALL PROPOSED IMPROVEMENTS WITHIN THE SHA RIGHT-OF-WAY ARE SHOWN FOR REFERENCE ONLY ON THIS PLAN. REFER TO THE APPROVED SHA PLANS FOR THE FINAL DESIGN, APPLICABLE DETAILS AND SPECIFICATIONS.

BENCHMARK INFORMATION

ELEVATIONS ARE BASED ON NAVD 88. COORDINATES AND MERIDIAN ARE BASED ON THE MARYLAND COORDINATE SYSTEM (MCS) PER THE FOLLOWING MONUMENTS.

BCO# 1433 (CAPPED REBAR)
N 571.683.79, E 1.466.230.89, ELEV. 16.59
IN MEDIAN OF NORTH POINT BLVD SOUTH OF NORTH SNYDER AVE.

GIS #2 (BRASS DISK)
N 565.182.39, E 1.464.480.72, ELEV. 9.95
EAST SIDE OF WHARF ROAD 420' NORTH OF LIGHT TOWER

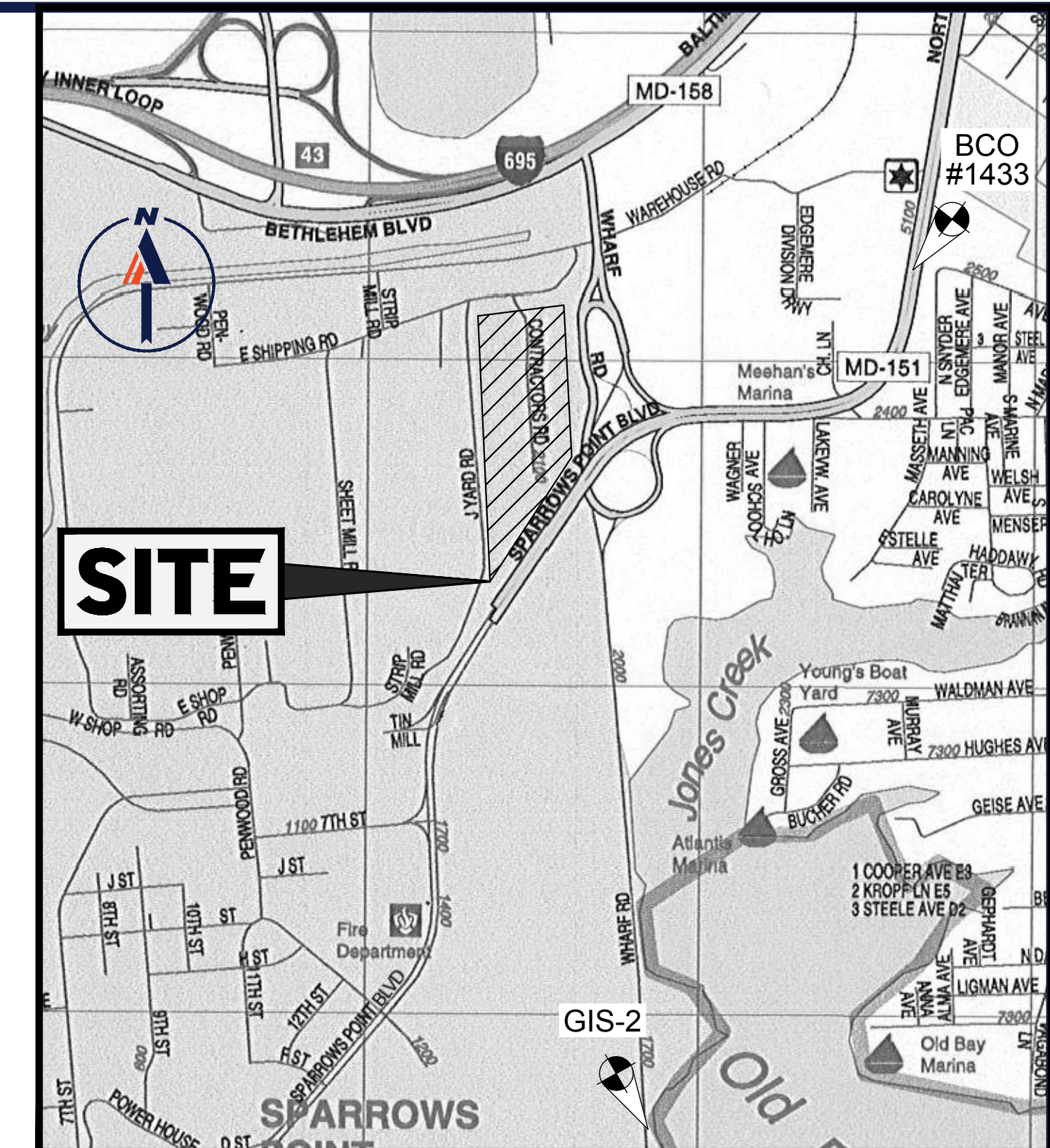

LOCATION MAP

COPYRIGHT ADC THE MAP PEOPLE
PERMIT USE NO. 20602153-5
SCALE: 1"=1000'

BOHLER
SITE CIVIL AND CONSULTING ENGINEERING
PROGRAM MANAGEMENT
LANDSCAPE ARCHITECTURE
SUSTAINABLE DESIGN
PERMITTING SERVICES
TRANSPORTATION SERVICES

REVISIONS

REV	DATE	COMMENT	DRAWN BY	CHECKED BY

811
Know what's below.
Call before you dig.
ALWAYS CALL 811
It's fast. It's free. It's the law.

NOT APPROVED FOR CONSTRUCTION

THIS DRAWING IS INTENDED FOR MUNICIPAL AND/OR AGENCY REVIEW AND APPROVAL. IT IS NOT INTENDED AS A CONSTRUCTION DOCUMENT UNLESS INDICATED OTHERWISE.

PROJECT No.: MD1620669
DRAWN BY: ISL/MJR
CHECKED BY: MUG
DATE: 4/17/2020
CAD ID: MD1620669-SSP-0

PROJECT:

PROJECT VIPER

FOR
TRADEPOINT ATLANTIC
PHASE II PLANS
1800 SPARROWS POINT BOULEVARD
BALTIMORE, MD 21219
TM 111, GRID 14, PARCEL 318
ELECTION DISTRICT 15
COUNCILMANIC DISTRICT 7
BALTIMORE COUNTY

BOHLER
901 DULANEY VALLEY ROAD, SUITE 801
TOWSON, MARYLAND 21204
Phone: (410) 821-7900
Fax: (410) 821-7987
MD@BohlerEng.com

M.J. GESELL
PROFESSIONAL ENGINEER
MARYLAND LICENSE NO. 4409
PROFESSIONAL CERTIFICATION
I, MICHAEL J. GESELL, HEREBY CERTIFY THAT THESE DOCUMENTS WERE PREPARED OR APPROVED BY ME, AND THAT I AM A DULY LICENSED PROFESSIONAL ENGINEER UNDER THE LAWS OF THE STATE OF MARYLAND. LICENSE NO. 4409, EXPIRATION DATE: 6/30/21

SHEET TITLE:
OVERALL SITE PLAN
SHEET NUMBER:
C-301
ORG. DATE - 4/17/2020

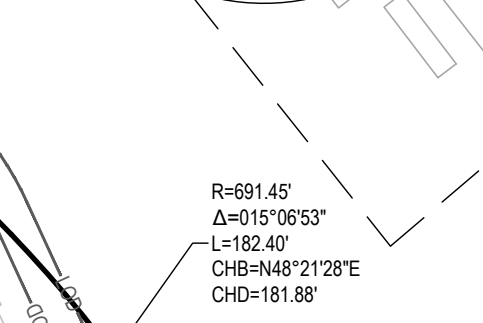
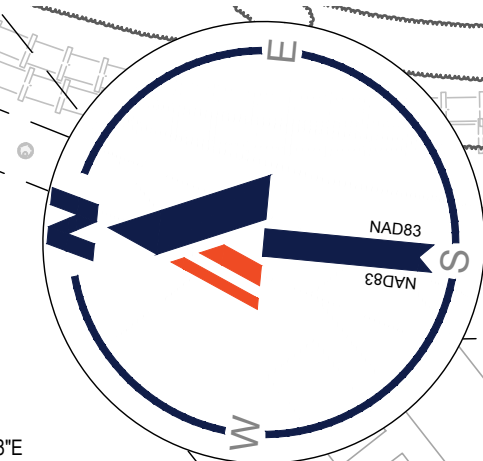
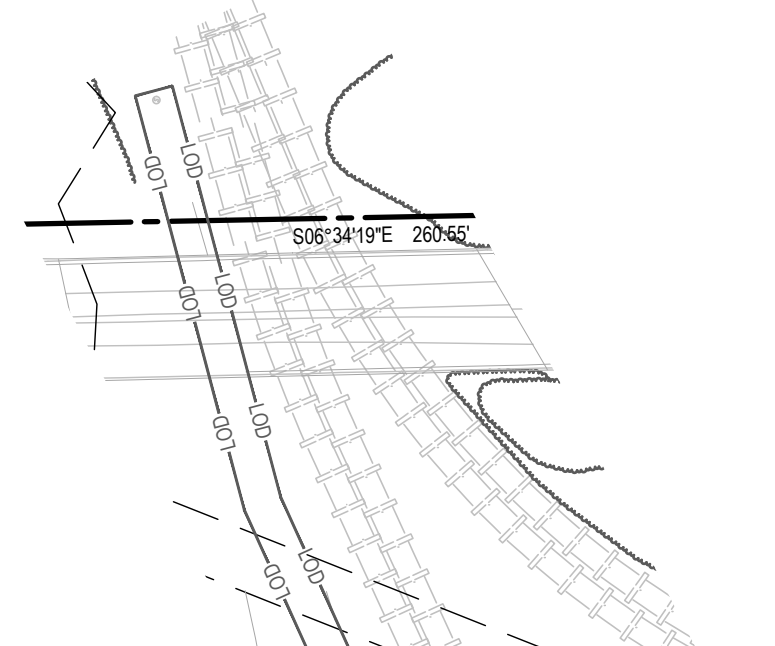
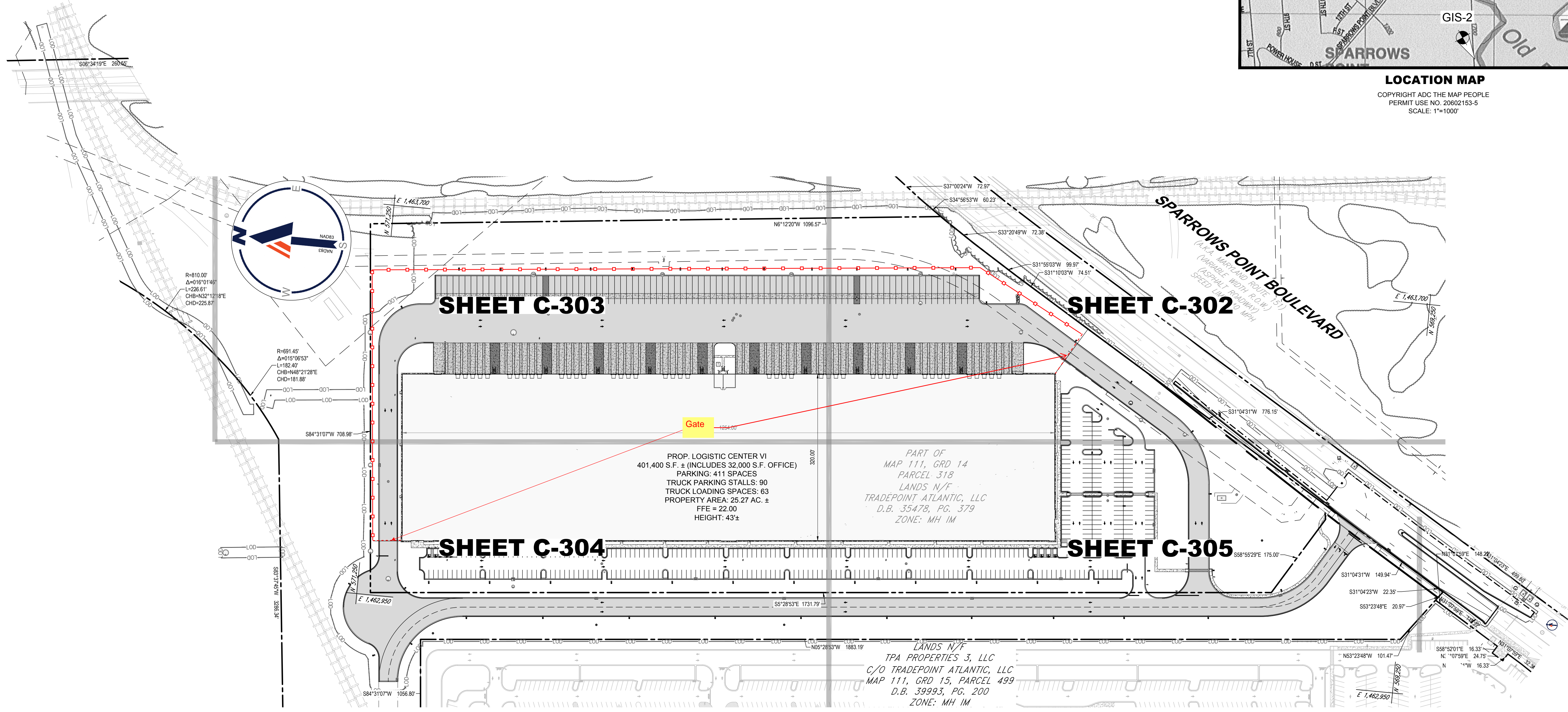

Gate

PROP. LOGISTIC CENTER VI
401,400 S.F. ± (INCLUDES 32,000 S.F. OFFICE)
PARKING: 411 SPACES
TRUCK PARKING STALLS: 90
TRUCK LOADING SPACES: 63
PROPERTY AREA: 25.27 AC. ±
FFE = 22.00
HEIGHT: 43'±

PART OF
MAP 111, GRD 14
PARCEL 318
LANDS N/F
TRADEPOINT ATLANTIC, LLC
D.B. 35478, PG. 379
ZONE: MH IM

LANDS N/F
TPA PROPERTIES 3, LLC
C/O TRADEPOINT ATLANTIC, LLC
MAP 111, GRD 15, PARCEL 499
D.B. 39993, PG. 200
ZONE: MH IM

MARYLAND COORDINATE SYSTEM (MCS)

ELEVATIONS BASED ON NAVD 88. COORDINATES AND MERIDIAN ARE BASED ON THE MARYLAND COORDINATE SYSTEM (MCS) PER MONUMENTS BCO #1433 AND GIS 2.

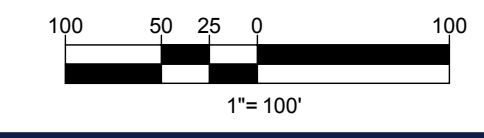

H:\16100\1620669\DRAWINGS\PLAN SET\PHASE II & CONSTRUCTION DOCUMENTS\MD1620669-SSP-0-LAYOUT\C-301-OVERALL SITE PLAN

APPENDIX E

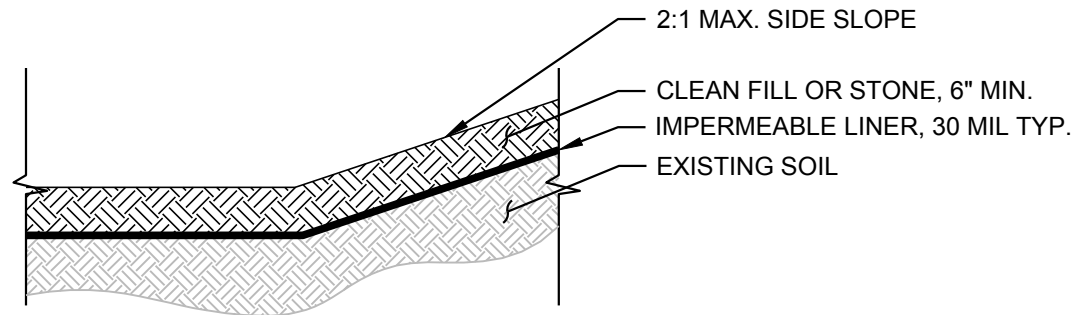
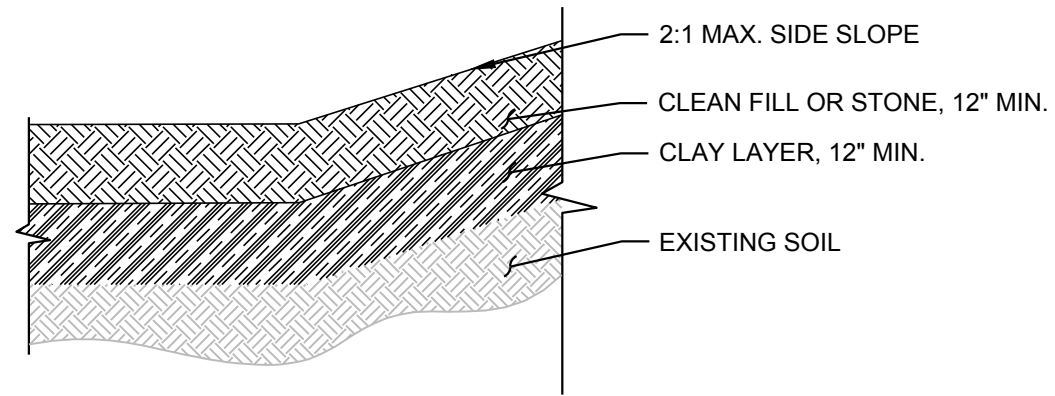

TYPICAL POND SECTIONS
NOT TO SCALE

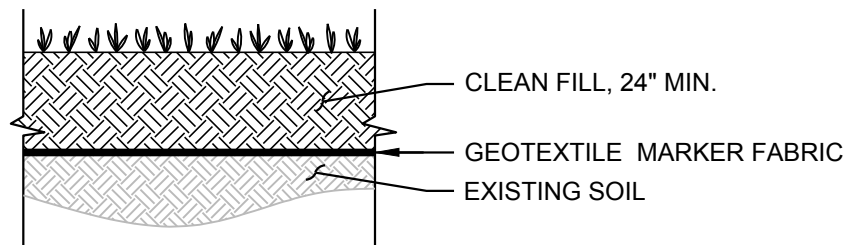

TYPICAL LANDSCAPE SECTION
NOT TO SCALE

GEOTEXTILE MARKER FABRIC SPECIFICATIONS

THE GEOTEXTILE MARKER FABRIC SHALL BE A NONWOVEN PERVIOUS SHEET OF POLYPROPYLENE MATERIAL. ADD STABILIZERS AND/OR INHIBITORS TO THE BASE MATERIAL, AS NEEDED, TO MAKE THE FILAMENTS RESISTANT TO DETERIORATION BY ULTRAVIOLET LIGHT, OXIDATION AND HEAT EXPOSURE. REGRIND MATERIAL, WHICH CONSISTS OF EDGE TRIMMINGS AND OTHER SCRAPS THAT HAVE NEVER REACHED THE CONSUMER, MAY BE USED TO PRODUCE THE GEOTEXTILE. POST-CONSUMER RECYCLED MATERIAL MAY BE USED. GEOTEXTILE SHALL BE FORMED INTO A NETWORK SUCH THAT THE FILAMENTS OR YARNS RETAIN DIMENSIONAL STABILITY RELATIVE TO EACH OTHER, INCLUDING THE EDGES. GEOTEXTILES SHALL MEET THE REQUIREMENTS SPECIFIED IN TABLE 1. WHERE APPLICABLE, TABLE 1 PROPERTY VALUES REPRESENT THE MINIMUM AVERAGE ROLL VALUES IN THE WEAKEST PRINCIPAL DIRECTION. VALUES FOR APPARENT OPENING SIZE (AOS) REPRESENT MAXIMUM AVERAGE ROLL VALUES

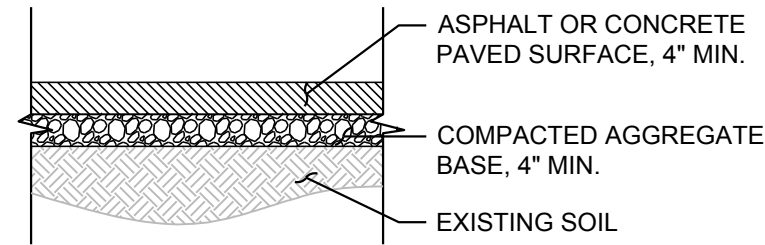

TYPICAL PAVING SECTION
NOT TO SCALE

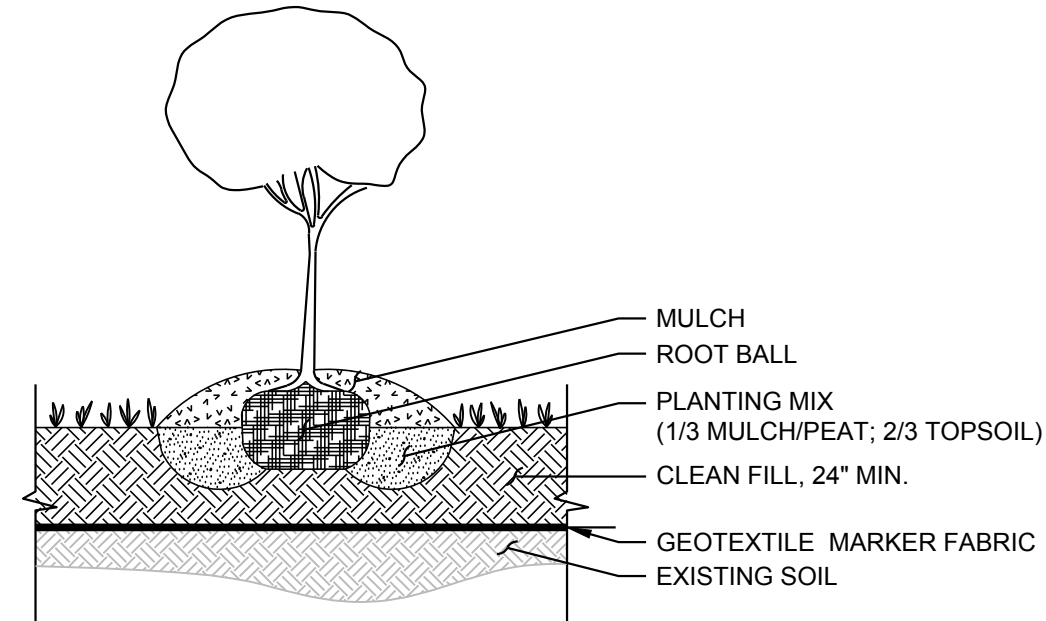

TYPICAL PLANTING SECTION
NOT TO SCALE

TCDNG'3"

Mechanical Properties	Test Method	Unit	Minimum Average Roll Value	
			MD	CD
Grab Tensile Strength	ASTM D4632	lbs (N)	120 (534)	120 (534)
Grab Tensile Elongation	ASTM D4632	%	50	50
Trapezoid Tear Strength	ASTM D4533	lbs (N)	50 (223)	50 (223)
CBR Puncture Strength	ASTM D6241	lbs (N)	310 (1380)	
Maximum Opening Size				
Apparent Opening Size (AOS)	ASTM D4751	U.S. Sieve (mm)	70 (0.212)	
Minimum Roll Value				
Permittivity	ASTM D4491	sec ⁻¹	1.7	
Flow Rate	ASTM D4491	gal/min/ft ² (l/min/m ²)	135 (5500)	
Minimum Test Value				
UV Resistance (at 500 hours)	ASTM D4355	% strength retained	70	

P:\EnviroAnalytics Group\60443M EAG_TPA Redevelopment\Drawg\B6\Production\Figure 6b - Environmental Capping Detail.dwg Plotted: April 9, 2019

scale	N/A
date	2/1/2020
project no.	160443M

designed: RJC
checked: TNP
drawn: RJC

O R I O W O "CAPPING SECTION DETAILS

SPARROWS POINT
BALT. COUNTY, MARYLAND

drawing title

project title

SPARROWS POINT
ENVIROANALYTICS GROUP

APPENDIX F

GENERAL NOTES:

1. ALL PIPES OR CONDUIT SHALL BE LEAK-PROOF AND WATERTIGHT. ALL JOINTS SHALL BE SEALED OR GASKETED.
2. ALL PIPES SHALL BE PROPERLY PLACED AND BEDDED TO PREVENT MISALIGNMENT OR LEAKAGE. PIPE BEDDING SHALL BE INSTALLED IN SUCH A MANNER AS TO MINIMIZE THE POTENTIAL FOR ACCUMULATION OF WATER AND CONCENTRATED INFILTRATION.
3. MINIMUM COVER ABOVE UTILITY SHALL BE BASED ON SPECIFIC UTILITY REQUIREMENTS.
4. TRENCHES SHALL BE BACKFILLED WITH BEDDING AND MATERIALS APPROVED BY MDE.
5. FOR ANY UTILITY SEGMENT WHICH GOES THROUGH AN AREA WHICH IS DESIGNATED TO RECEIVE A LANDSCAPED CAP, THE UPPER 2 FEET OF BACKFILL MUST MEET THE REQUIREMENTS OF MDE VCP CLEAN FILL FOR INDUSTRIAL LAND USE. IN THIS CASE THE MDE VCP CLEAN FILL WILL BE UNDERLAIN BY A GEOTEXTILE MARKER FABRIC. UTILITY SEGMENTS WHICH GO THROUGH AREAS WHICH DO NOT REQUIRE CAPPING OR ARE DESIGNATED TO RECEIVED A PAVED CAP WILL BE BACKFILLED WITH MATERIALS APPROVED BY MDE FOR THIS USE.

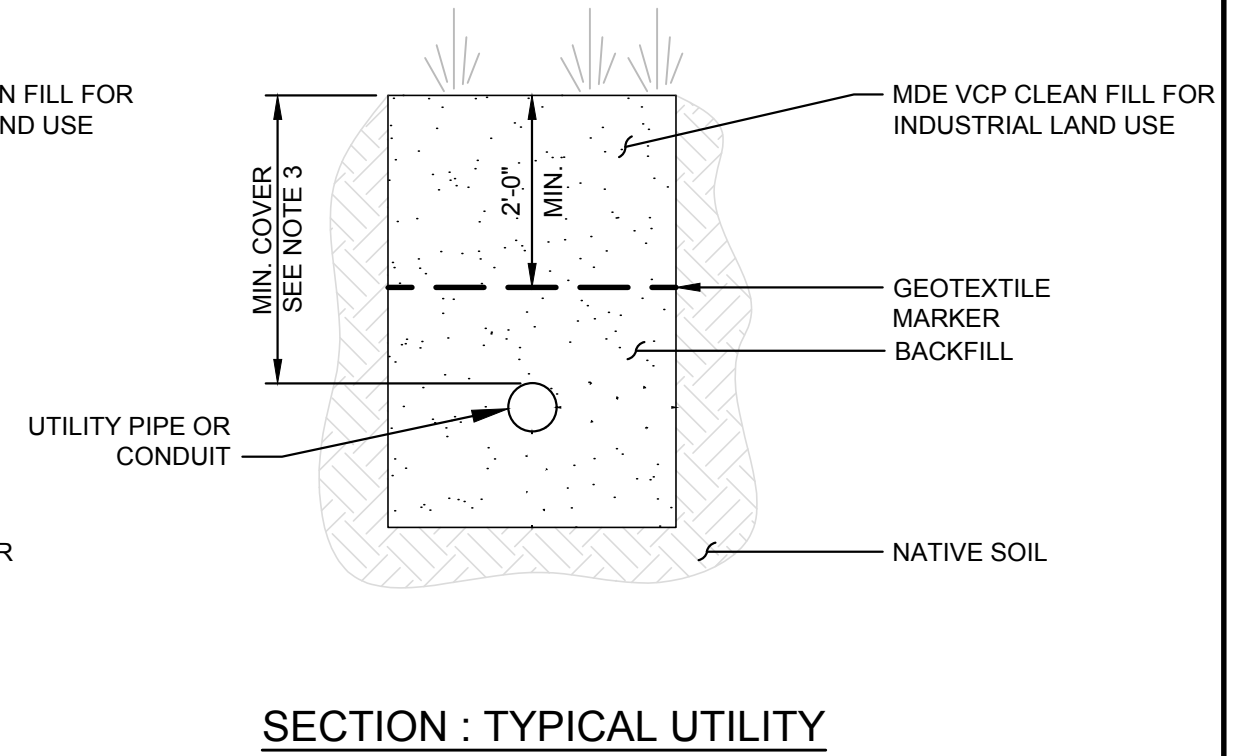
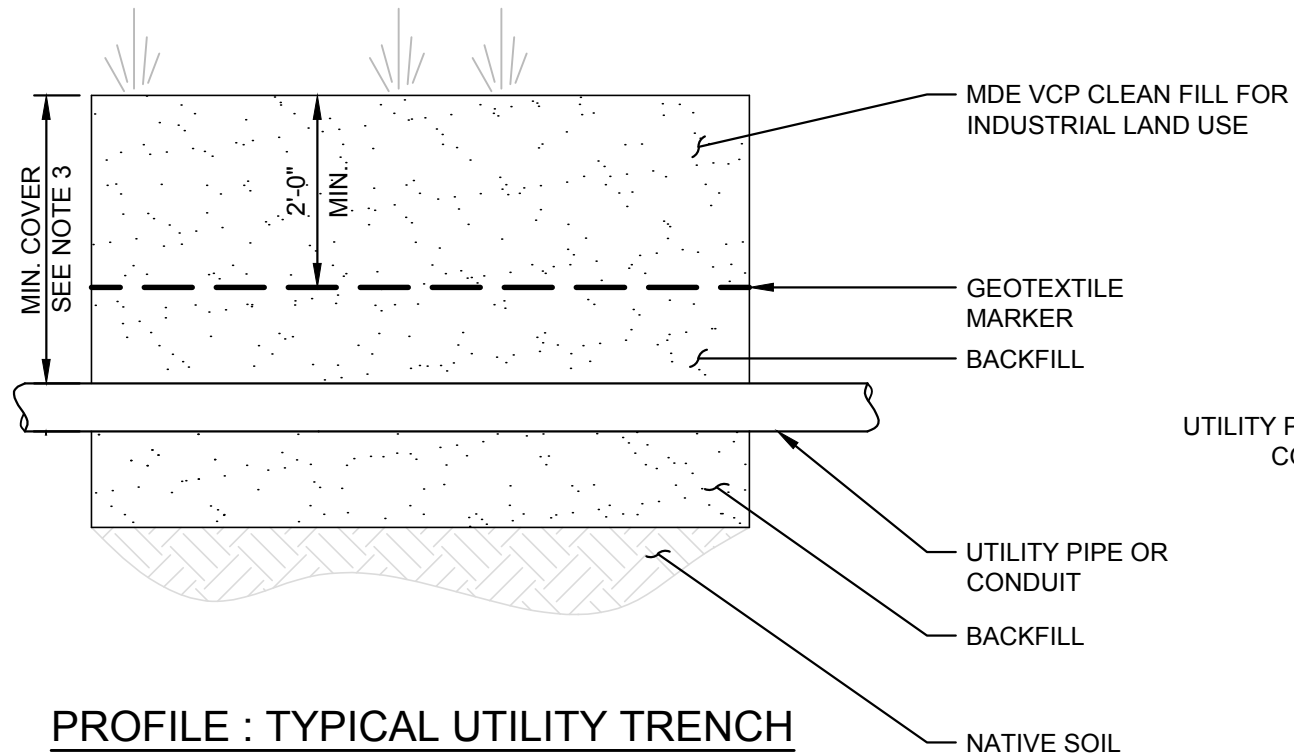
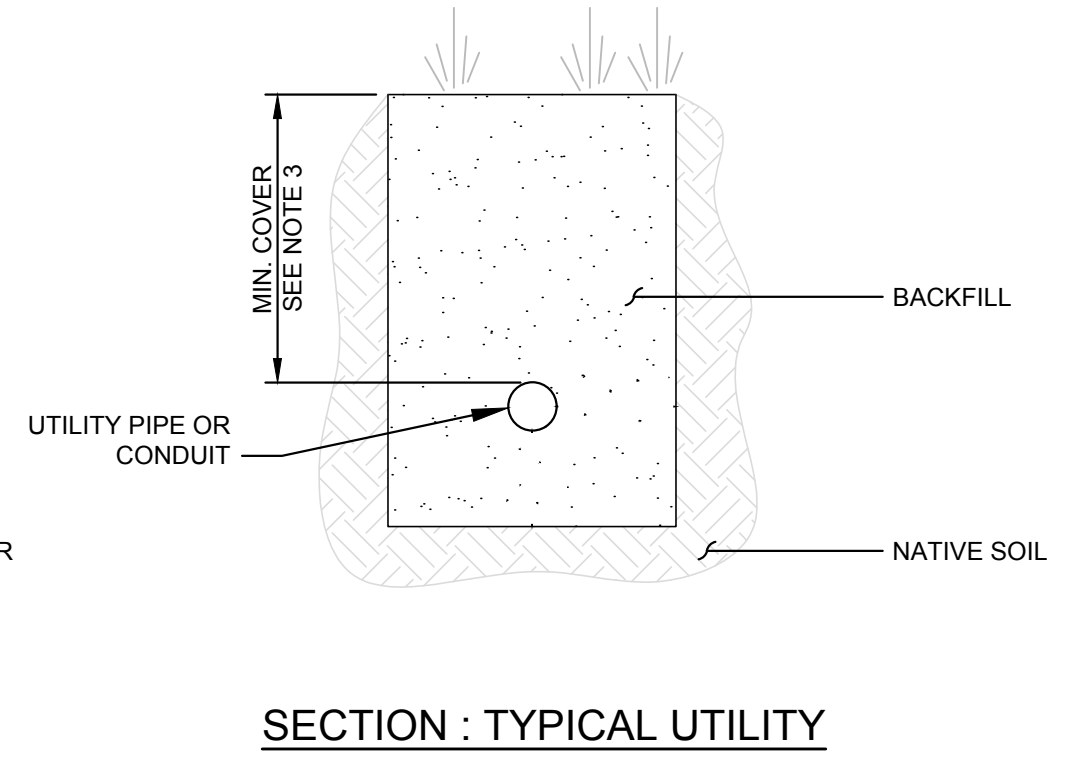
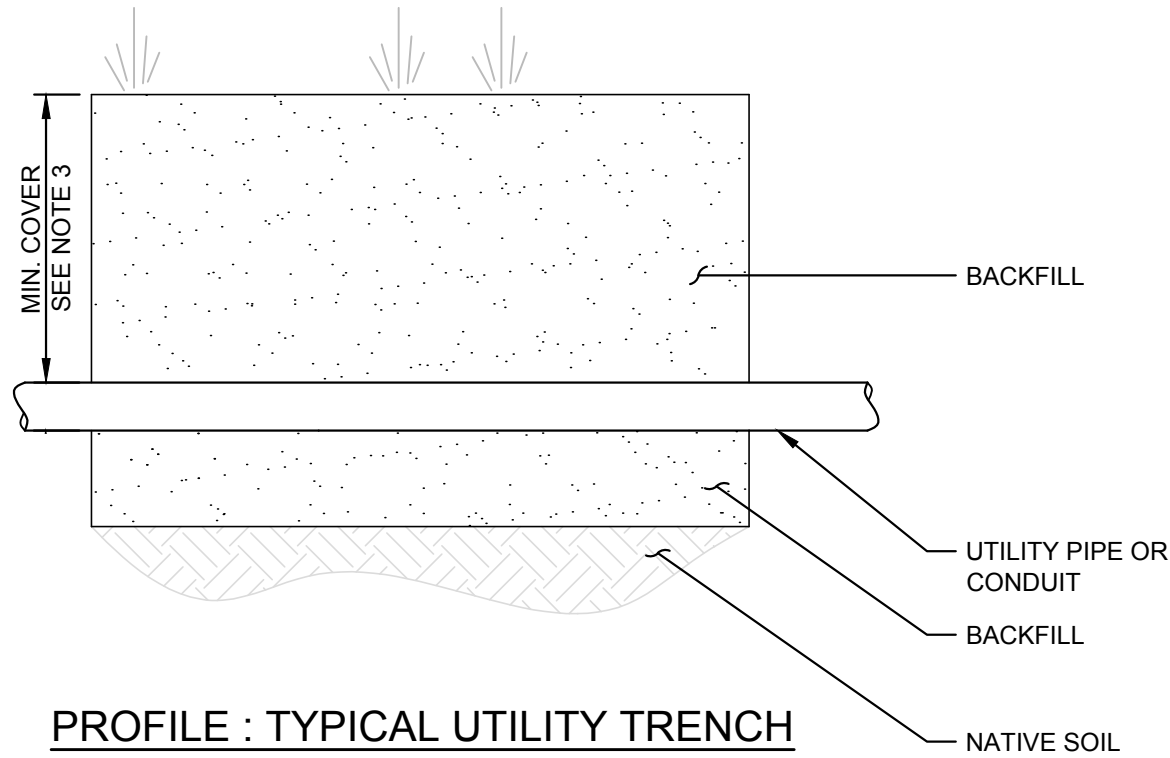

CRRGF KZ'I "

Utility Excavation NAPL Contingency Plan

Revision 4 – June 19, 2017

Introduction:

Proposed underground utilities and excavations necessary for the redevelopment of the Tradepoint Atlantic property may encounter areas of petroleum and/or Oil & Grease contamination in soil. The assessment of total petroleum hydrocarbons (TPH) diesel range organics (DRO), gasoline range organics (GRO), Oil & Grease, and/or non-aqueous phase liquid (NAPL) completed as part of each Phase II Investigation includes the following:

- Each soil boring with evidence of NAPL (i.e., containing a sheen or free oil in the soil core), whether located near utilities or not, is investigated via the installation of a piezometer to assess mobility to groundwater. If measureable NAPL is present in the initial piezometer, additional soil borings and shallow temporary piezometers are installed surrounding the initial detection to delineate the impacts. Each piezometer installed to delineate the presence or absence of NAPL is checked with an oil-water interface probe immediately after installation, 48 hours after installation, and at least 30 days after installation.
- TPH-DRO/GRO and Oil & Grease data, once received, are assessed in their magnitude and location respective to subsurface utilities, stormwater conveyances, and surface waters.
- Locations that exhibit elevated detections of TPH/Oil & Grease or evidence of NAPL, that are within reasonable proximity (i.e. 25 feet) to subsurface utilities or stormwater conveyances and/or within reasonable proximity (i.e. 100 feet) to surface waters, are identified for further delineation and selective removal (if warranted).

Any NAPL identified in soil borings or piezometers during the Phase II Investigation would be noted on relevant logs and identified in Response and Development Work Plans for construction planning purposes. Despite these planning efforts, unidentified pockets of contamination (including NAPL) may still be encountered during construction. This contingency plan provides the procedures to be utilized during construction work to properly address response and construction techniques if any materials impacted with NAPL are encountered.

Objectives:

The purpose of this plan is to describe procedures to be followed in the event that NAPL is encountered in utility trenches or other excavations during development of the Tradepoint Atlantic property. The specific objectives of this plan and the procedures outlined herein are:

1. To ensure identification and proper management of Oil & Grease and petroleum-contaminated soils.
2. To ensure proper worker protection for working in areas of Oil & Grease and petroleum contamination.
3. To ensure that the installation of new utilities does not create new preferential flow paths for the migration of free-phase hydrocarbons (Oil & Grease, TPH-DRO/GRO, etc.) or soil vapors.

Identification of Oil & Grease and Petroleum Contaminated Soil:

An Environmental Professional (EP) will be on-site to determine if soils show evidence of the presence of Oil & Grease or TPH present as NAPL during installation of utility trenches or other excavation activities completed during development. Oil & Grease or petroleum-contaminated soils can be identified by the presence of free oil, oil staining, a petroleum odor, or any combination of these conditions. Free oil (NAPL) is liquid oil which could potentially be drained or otherwise extracted from the soil, and is the focus of this contingency plan, although severe staining accompanied by odors should be addressed via the same contingency measures provided herein (based on the judgement of the EP). The appearance of oil staining is not always consistent, but varies depending on the nature of the oil, the soil type, and the age of the release. Staining associated with old petroleum contamination often has a greenish hue, but may also be brown or black. The olfactory sense is the most sensitive instrument for identifying petroleum contamination in the field. Therefore, a petroleum odor may be noted although there is no visible sign of oil or staining. In some instances, decaying organic matter can produce an odor similar to petroleum, but this is rare.

If NAPL is encountered during construction, the extent of impacts shall be delineated by excavating trenches or installing four soil borings (two in each direction) perpendicular to the utility alignment or excavation to examine the soil for physical evidence of NAPL. Perpendicular transects will be investigated every 50 feet along the section of the utility trench or excavation where there is physical evidence of NAPL. Each transect will extend to a distance of 10 feet from the edge of the utility trench or excavation. This represents the maximum distance which would require mandatory excavation to mitigate potential migration risks (see below).

NAPL delineation will be guided primarily by screening observations from the perpendicular borings or trenches, and samples will be collected to test for extractable Oil & Grease or petroleum-contaminated soil using the Oil Sticks™ test kit. This test kit provides a determination of whether hydrocarbons are present in soil and extractable (i.e. could mobilize as a NAPL). Oil Sticks™ change from a pale blue to a deep blue color when they come in contact with free product. This instantaneous change in color occurs even when miniscule amounts of product come in contact with the strip. The sensitivity of Oil Sticks™ to determine the presence/absence of oil is reported by the manufacturer to be about 1,000 to 2,000 mg/kg. The

field test is performed by placing approximately 3 tablespoons of soil in a clean sample cup and adding enough water to cover the sample. After stirring the sample and waiting ~1 minute, the Oil Sticks™ test strip should be swished through the water, making sure to touch the strip to the sides of the cup where product may collect at the interface (meniscus) between the cup, water, and air. If the strip turns deep blue, or deep blue spots appear, oil or hydrocarbon is present. However, the MDE has observed that the Oil Sticks™ method may produce inconsistent results. Therefore, documentation of all screening methods is necessary during boring/trenching work. This documentation shall include an accurate record of visual and olfactory screening, along with a narrative with photographs. Field screening will be aided by photoionization detector (PID) results, and Oil Sticks™ samples should be biased to target elevated PID readings, if any. The agencies have requested that all soil samples prepared for the Oil Sticks™ field test be photographed for evidence of sheen/residue on the cup sides. Detailed records are required to be submitted with the project-specific Completion Report.

If petroleum or Oil & Grease impacts are identified in Site soils based on use of the Oil Sticks™ test kit or other field screening methods, disposal requirements will be determined using the quantitative PetroFLAG™ hydrocarbon analysis system or fixed laboratory analysis (see following section). The PetroFLAG™ hydrocarbon analysis system is a broad spectrum field test kit suitable for TPH contamination regardless of the source or state of degradation (Dexsil Corporation). PetroFLAG™ field test kits do not distinguish between aromatic and aliphatic hydrocarbons, but quantify all fuels, oils, and greases as TPH. Dilutions can be used to determine concentrations of TPH/Oil & Grease above the normal calibration range. Dexsil notes that positive results for TPH may occur if naturally occurring waxes and oils, such as vegetable oils, are present in the sample. Additional detail regarding the procedure for the PetroFLAG™ kit is given in **Attachment 1**.

Soil Excavation, Staging, Sampling and Disposal:

The EP will monitor all utility trenching and excavation activities for signs of potential contamination. In particular, soils will be monitored with a hand-held PID for potential VOCs, and will also be visually inspected for the presence of staining, petroleum waste materials, or other indications of NAPL contamination that may be different than what was already characterized. Excavated material that is visibly stained or that exhibits a sustained PID reading of greater than 10 ppm will be segregated and containerized or placed in a stockpile on polyethylene or impervious surface until the material can be analyzed using the PetroFLAG™ test kit to characterize the material for appropriate disposal. If a PetroFLAG™ test kit is not available to the contractor, or if the contractor prefers to use fixed laboratory analysis, samples may be characterized via submittal to a laboratory for TPH/Oil & Grease analysis. However, any excavated material containing NAPL (i.e., containing free oil) cannot be characterized for waste disposal using the PetroFLAG™ test kit and must instead be characterized via fixed laboratory analysis, as described in the final paragraph of this section. In addition, any hydrocarbon contaminated soil discovered during construction activities that was not previously

characterized must also be analyzed for PCBs prior to removal and transport to an appropriate disposal facility. If excavated and stockpiled, such materials will be covered with a plastic tarp so that the entire stockpile is encapsulated, and anchored to prevent the elements from affecting the integrity of the containment. The MDE will be notified if such materials are encountered during utility work.

Soil exhibiting physical evidence of NAPL contamination or elevated TPH/Oil & Grease with detections in the low percentage range, which is located within 10 feet of a proposed new utility or subsurface structure (i.e., foundation, sump, electrical vault, underground tank, etc.), will be excavated and segregated for disposal at the on-site nonhazardous landfill (Greys Landfill) or an off-site facility pending the completion of any required PCB analytical testing. Impacted soil which is located greater than 10 feet away from the proposed utility or subsurface structure may be left in place and undisturbed. The extent of the excavation will be determined in the field following visual/olfactory screening supplemented by the PID and Oil Sticks™ test kit, but soil disposal requirements will be determined with the PetroFLAG™ test kit (since the Oil Sticks™ method is not quantitative) or via fixed laboratory analysis for TPH/Oil & Grease (if preferred by the contractor or if the PetroFLAG™ test kit is unavailable to the contractor).

Any recovered NAPL will be collected for off-site disposal. As required by the appropriate and MDE approved facility, samples impacted by NAPL (i.e., containing free oil) will be collected for profiling/waste characterization and submitted to a fixed laboratory, as mentioned above, for the following analyses: metals, VOCs, TPH-DRO/GRO, and/or additional analysis required by the selected disposal facility. Upon receipt of any additional characterization analytical results, the MDE will be notified of the proposed disposal facility. Non-impacted material with no evidence of NAPL (i.e. soils that may contain measureable concentrations of TPH/Oil & Grease but below percentage levels) may be placed on the Site in areas to be paved or capped as long as all other requirements specified in the Response and Development Work Plan (or similar governing document) are met.

Initial Reporting:

If evidence of NAPL in soil or groundwater is encountered during excavation, it will be reported to the MDE within two hours. Information regarding the location and characteristics of any NAPL contaminated soil will be documented as follows:

- Location (exact stationing);
- Extent of contamination (horizontally and vertically – prepare a sketch including dimensions);
- Relative degree of contamination (i.e. free oil with strong odor vs. staining); and
- Visual documentation (take photographs and complete a photograph log)

Utility Installations in Impacted Areas:

Underground piping or conduits installed through areas of Oil & Grease or petroleum contamination shall be leak proof and water tight. All joints will be adequately sealed or gasketed, and pipes or conduits will be properly bedded and placed to prevent leakage. All trench backfill will meet the MDE definition of clean fill, or otherwise be approved by the MDE. Pipe bedding will be installed to minimize the potential for accumulation of water and concentrated infiltration. This can be achieved by using a relatively small amount of low-permeability pipe bedding; open-graded stone will be avoided or only used in thicknesses of 6 inches or less. Bedding must be properly placed and compacted below the haunches of the pipe. Clay, flowable fill, or concrete plugs will be placed every 100 feet across any permeable bedding to minimize the preferential flow and concentration of water along the bedding of such utilities.

If required, each trench plug will be constructed with a 2-foot-thick clay plug or 1-foot-thick flowable fill or concrete plug, perpendicular to the pipe, which extends at least 1 foot in all directions beyond the permeable pipe bedding. The plug acts as an anti-seep collar, and will extend above the top of the pipe. Installation of each trench plug will follow the completion of the trench excavation, installation of granular pipe bedding (because dense-graded aggregate or soil or other pipe bedding is difficult to properly compact below the haunches of the pipe), and seating of the pipe. The trench plug will then be installed by digging out a 1-foot trench below and around the pipe corridor, and placing clay, flowable fill, or concrete to construct the plug. A specification drawing for installation of the trench plug has been provided as **Figure 1**.

Attachment 1 - PetroFLAG™ Procedure

PetroFLAG™ field test kits use a proprietary turbidimetric reaction to determine the TPH concentration of solvent extracted samples (USEPA). Calibration standards provided with the unit are used to perform a two-point calibration for the PetroFLAG™. A blank and a 1,000 ppm standard are run by the analyzer unit to create an internal calibration curve.

Analysis of a soil sample is performed using three simple steps: extraction, filtration, and analysis. The PetroFLAG™ analysis is performed as follows:

- Place a 10 gram soil sample in a test tube.
- Add extraction solvent to the tube.
- Shake the tube intermittently for four minutes.
- Filter the extract into a vial that contains development solution
- Allow the solution to react for 10 minutes.

The filtration step is important because the PetroFLAG™ analyzer measures the turbidity or "optical density" of the final solution. Approximately 25 samples can be analyzed per hour. The vial of developed solution is placed in the meter, and the instrument produces a quantitative reading that reveals the concentration of hydrocarbons in the soil sample. The PetroFLAG™ method quantifies all fuels, oils, and greases as TPH between 15 and 2000 ppm (Dexsil Corporation). A 10x dilution of the filtered extraction solvent will be completed to allow for quantification of soil concentrations in excess of 10,000 ppm. The specially designed PetroFLAG™ analyzer allows the user to select, in the field, the response factor that is appropriate for the suspected contaminant at each site. Vegetable-based oils have been shown to exhibit a response factor of 18% (EPA Method 9074). Using the selected response factor, the analyzer compensates for the relative response of each analyte and displays the correct concentration in parts per million (ppm).

References:

U.S. Environmental Protection Agency (EPA). Contaminated Site Clean-up Information (Clu-IN): Test Kits. Office of Superfund Remediation and Technology Innovation. <http://www.clu-in.net/characterization/technologies/color.cfm>

Dexsil Corporation. 2016. PetroFLAG Analyzer System (PF-MTR-01). http://www.dexsil.com/products/detail.php?product_id=23

EPA SW-846 Method Number 9074 - Turbidimetric Screening Procedure for Total Recoverable Hydrocarbons in Soil

GENERAL NOTES:

1. ALL PIPES OR CONDUIT PASSING THROUGH AREAS OF PETROLEUM CONTAMINATION SHALL BE LEAK-PROOF AND WATERTIGHT. ALL JOINTS SHALL BE SEALED OR GASKETED.
2. ALL PIPES SHALL BE PROPERLY PLACED AND BEDDED TO PREVENT MISALIGNMENT OR LEAKAGE. PIPE BEDDING SHALL BE INSTALLED IN SUCH A MANNER AS TO MINIMIZE THE POTENTIAL FOR ACCUMULATION OF WATER AND CONCENTRATED INFILTRATION.
3. ANTI-SEEP COLLARS FROM THE PIPE MANUFACTURER, THAT ARE PRODUCED SPECIFICALLY FOR THE PURPOSE OF PREVENTING SEEPAGE AROUND THE PIPE, ARE ACCEPTABLE IF INSTALLED IN STRICT ACCORDANCE WITH THE MANUFACTURER'S RECOMMENDATIONS, AND ONLY WITH PRIOR APPROVAL BY EAG.
4. MINIMUM COVER ABOVE UTILITY SHALL BE BASED ON SPECIFIC UTILITY REQUIREMENTS.
5. TRENCHES SHALL BE BACKFILLED WITH BEDDING AND MATERIALS APPROVED BY MDE.
6. FOR ADDITIONAL REQUIREMENTS, INCLUDING THE USE OF MDE VCP CLEAN FILL FOR INDUSTRIAL LAND USE AND INSTALLATION OF GEOTEXTILE MARKER FABRIC, REFER TO NOTE 5 ON THE TYPICAL UTILITY CROSS SECTIONS.
7. ALL UTILITIES INSTALLED THROUGH AREAS CONTAINING NAPL OR ELEVATED CHEMICAL IMPACTS WITH THE POTENTIAL TO TRANSMIT VAPORS ALONG PREFERENTIAL FLOW PATHWAYS SHALL BE EITHER 1) BACKFILLED WITH LOW PERMEABILITY BACKFILL MATERIAL (LESS THAN OR EQUAL TO THE PERMEABILITY OF THE EXISTING SUBGRADE), OR 2) INSTALLED WITH TRENCH PLUGS ALONG THE ALIGNMENT IN ACCORDANCE WITH THE DETAILS SHOWN ON THIS PLAN AND THE FOLLOWING NOTES:
 - A.) UTILITY TRENCH PLUGS SHALL BE INSTALLED AT 100-FOOT (MAX.) INTERVALS THROUGH ALL AREAS OF NAPL CONTAMINATION.
 - B.) UTILITY TRENCH PLUGS SHALL EXTEND A MINIMUM OF 1-FOOT IN ALL DIRECTIONS BEYOND ANY HIGHER PERMEABILITY BACKFILL MATERIALS (I.E., MATERIALS EXCEEDING THE PERMEABILITY OF THE EXISTING SUBGRADE).

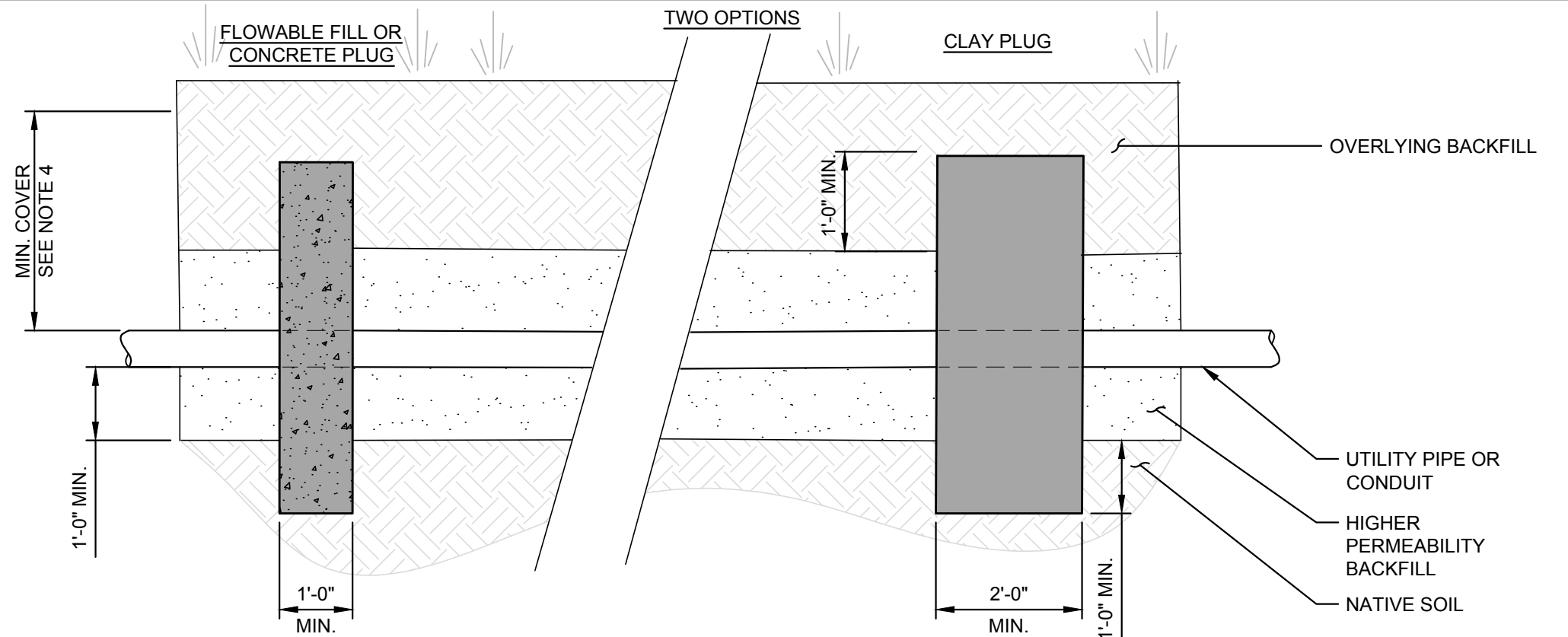

SECTION : TYPICAL UTILITY TRENCH PLUG

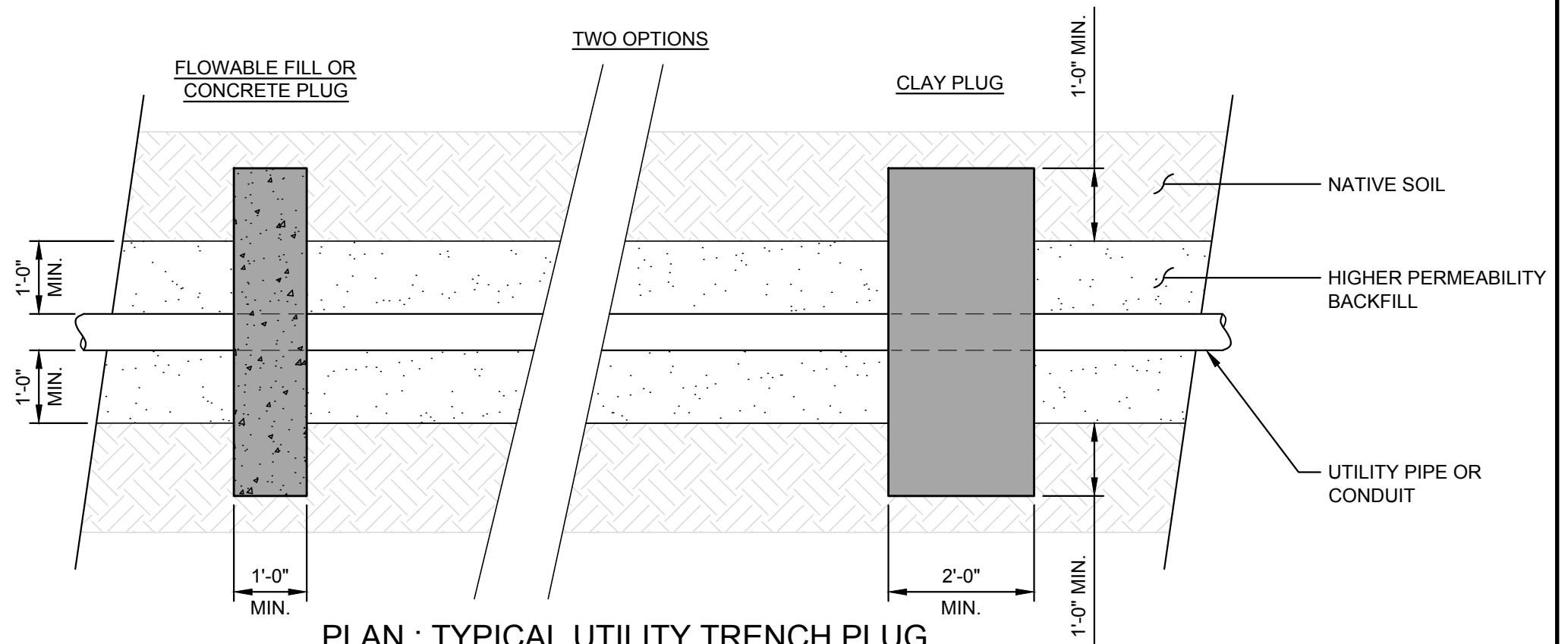

PLAN : TYPICAL UTILITY TRENCH PLUG

This drawing, its contents, and each component of this drawing are the property of and proprietary to ARM Group LLC, and shall not be reproduced or used in any manner except for the purpose identified on the Title Block, and only by or on behalf of this client for the identified project unless otherwise authorized by the express, written consent of ARM Group LLC.



UTILITY TRENCH PLUG
Sparrows Point Site
EnviroAnalytics Group, LLC

January 2020
Not to Scale
160443M

Figure
1

P:\EnviroAnalytics Group\160443M EAG_TPA Redevelopment\Drawings\NAPL_Contingency\SK01_Utility Trench Plug_rev2.dwg Plotted: September 24, 2018

"

"

"

"

"

"

"

"

"

APPENDIX H

"

"

HEALTH AND SAFETY PLAN

SPARROWS POINT TERMINAL SPARROWS POINT, MARYLAND

Prepared by:



Environmental Engineers

January 2015

TABLE OF CONTENTS

1.0	Introduction.....	5
1.1	Background.....	5
1.2	Historic Operations.....	5
2.0	Purpose, Scope and Organization.....	6
2.1	Scope.....	6
2.2	Organization of Documents.....	7
2.3	EAG Health and Safety Personnel.....	7
3.0	Hazard Analysis.....	8
3.1	Hazard Analysis.....	8
3.1.1	Chemical Hazards.....	8
3.1.2	Physical Hazards.....	8
3.1.3	Biological Hazards.....	9
4.0	Health Hazard Information.....	9
4.1	Chemical Hazards.....	9
4.2	Physical Hazards.....	14
4.2.1	Heat Stress.....	14
4.2.2	Cold Stress.....	16
4.2.3	Lifting Hazards.....	16
4.2.4	Slips, Trips and Falls.....	17
4.2.5	Buried Hazards.....	17
4.2.6	Electrical Hazards.....	17
4.2.7	Heavy Equipment Operations.....	17
4.2.8	Drilling and Excavation Safety.....	18
4.2.9	Use of Hand Tools and Portable Power Tools.....	21
4.2.10	Noise.....	21
4.2.11	Work Zone Traffic Control.....	21
4.2.12	Work Over Water.....	21
4.2.13	Vehicle Use.....	22
4.3	Biological Hazards.....	22

5.0	Personal Protective Equipment.....	23
5.1	Level D Protection.....	23
5.2	Modified Level D Protection.....	23
5.3	Level C Protection.....	23
5.4	First Aid, Emergency and Safety Equipment.....	24
6.0	Personnel Training and Standard Safety Procedures.....	24
6.1	Onsite Safety, Health and Emergency Response Training.....	24
6.2	Standard Safety Procedures.....	25
6.2.1	General Safety Work Practices.....	25
6.2.2	Hand Safety.....	25
6.2.3	Respiratory Protection.....	26
6.2.4	Personal Hygiene Practices.....	27
6.2.5	Electrical Safety.....	27
6.2.6	Fire Safety.....	27
6.2.7	Illumination.....	27
6.2.8	Sanitation.....	28
7.0	Exposure Monitoring Plan.....	28
7.1	Air Monitoring.....	28
7.1.1	Combustible Gas and Oxygen Deficiency/Excess Monitoring.....	28
7.1.2	Organic Vapor Concentrations.....	29
7.2	Physical Conditions Monitoring.....	30
8.0	Medical Surveillance.....	30
8.1	Medical Surveillance Program.....	30
8.2	Physician Review.....	33
9.0	Site Control Measures and Decontamination.....	31
9.1	Site Control Measures.....	31
9.1.1	Work Zone Delineation.....	31
9.1.2	Communications.....	32
9.1.3	Site Security.....	32

9.2	Decontamination Procedures.....	33
9.2.1	Personal Decontamination.....	33
9.2.2	Equipment Decontamination.....	33
9.2.3	Waste Management.....	34
10.0	Emergency Response and Contingency Procedures.....	34
10.1	Emergency Phone Numbers.....	35
10.2	Injury/Illness Treatment.....	35
10.3	Occupational Health Clinic and Hospital Information.....	36
10.4	Accident and Emergency Medical Response.....	38
10.4.1	Chemical Exposure.....	38
10.4.2	Decontamination During Medical Emergency.....	38
10.4.3	Small or Incipient Fire.....	39
10.4.4	Large Fire or Explosion.....	39
10.4.5	Adverse Weather Conditions.....	39
10.4.6	First Aid for Heat Stress/Cold Stress.....	40
10.4.7	Snake Bites.....	40
10.4.8	Animal Bites.....	40
10.4.9	Insect Bites and Stings.....	41
10.4.10	Poisonous Plants.....	41
10.4.11	Ticks.....	41

ATTACHMENTS

Attachment A – EAG Acknowledgment Form

Attachment B – MSDSs

1.0 INTRODUCTION

1.1 Background

The Sparrows Point Terminal site has historically been a steel making facility. It is located in Baltimore County, Maryland in the southeast corner of the Baltimore metropolitan area (approximately 9 miles from the downtown area), on the Sparrows Point Peninsula in the Chesapeake Bay watershed. The facility occupies the entire peninsula and is bounded to the west by Bear Creek; to the south by Patapsco River; and to the east by Jones Creek, Old Road Bay and residential areas of the City of Edgemere. The facility is bounded to the north by the Sparrows Point Country Club. The site is approximately 3,100 acres in size.

Pennsylvania Steel built the furnace at Sparrows Point in 1887 and the first iron was cast in 1889. Bethlehem Steel Corporation (BSC) purchased the facility in 1916 and enlarged it by building additional and plating facilities. BSC filed for bankruptcy in 2001. A series of entities has owned the site between then and now: the International Steel Group (ISG), Mittal Steel, ISG Sparrows Point, LLC, Severstal Sparrows Holding LLC, which was renamed to Severstal Sparrows Point, LLC, RG Steel Sparrows Point, LLC, and then a joint venture to Sparrows Point LLC (SP) and HRE Sparrows Point LLC. Most recently, in 2014, the property and assets were sold to Sparrows Point Terminal LLC (SPT). Environmental liability was retained by SP and work is currently being conducted by EnviroAnalytics Group, LLC (EAG) on behalf of SP.

- In addition to the current environmental investigation and remediation being conducted onsite by EAG and their consultants, there are other entities conducting work on the facility. Demolition of the remaining structures is currently ongoing at the site, and those contractors are being managed by SPT.
- The purpose of this document is to provide an overall health and safety plan (HASP) for EAG personnel and EAG directed contractors who are engaging in environmental investigation and remediation activities onsite. EAG directed contractors will also be expected to have their own Health and Safety Program, and they may opt to draft their own site specific HASP, provided it meets the requirements in this HASP.

1.2 Historic Operations

Steel manufacturing involves handling vast amounts of raw material including coke, iron ore, limestone and scrap steel, as well as recovering byproducts and managing waste materials. The operations listed below either were or are currently performed at the Sparrows Point Facility.

- Iron and steel production
- Coal chemical recovery system
- Other byproducts recovery systems
- Wastewater treatment systems
- Solid waste management
- Air pollution control

A number of site-specific environmental and hydrogeologic investigations have been prepared for the Sparrows Point facility. For the purposes of this HASP, information was obtained from the “Special Study Area Release Site Characterization” completed in 2001 by CH2MHill, as well as additional documents submitted since that time. There are five separate Special Study Areas as put forth in the Consent Decree:

- Humphrey Impoundment,
- Tin Mill Canal/Finishing Mills Areas,
- Coke Oven Area,
- Coke Point Landfill, and
- Greys Landfill.

Contaminated soils and groundwater may be present at the site. This plan was prepared based on an assessment of hazards expected to be present and a review of data from the previous site investigations and groundwater sampling events.

During the current investigations and remedial efforts, all related work will be performed in accordance with the requirements of this HASP and Occupational Safety and Health Administration (OSHA) regulations as defined in 29 Code of Federal Regulations (CFR) 1910.120 and 1926.65.

2.0 PURPOSE, SCOPE AND ORGANIZATION

This section describes the purpose, scope and organization of this HASP and the health and safety responsibilities of EAG, their employees, and their subcontractors involved in the field investigation and remediation activities at the Sparrows Point facility.

2.1 Scope

Field investigation and remediation activities for this project may include, but are not limited to:

- Groundwater sampling and monitoring,
- Groundwater and remediation well installation,
- Groundwater and remediation well repairs,
- Groundwater and remediation well closure and abandonment,
- Surface water sampling,
- Sediment sampling,
- Soil boring and subsurface soil sampling,
- Soil excavations for remedial purposes,
- Installation and operation of remediation systems for soil, soil vapor, and groundwater,
- Decommissioning and closure of remediation systems,
- Soil excavations for remedial purposes,
- Insitu soil mixing/soil stabilization,
- Exsitu soil mixing/soil stabilization,
- Dredging operations along Tin Mill Canal,
- Insitu chemical and/or biological injections, and
- Recovery of non-aqueous phase liquids (NAPL)

When EAG personnel are providing oversight of subcontractors, they will attend the safety and health briefings held by the contractor. EAG personnel will follow the requirements of this HASP, as well as any potentially more stringent requirements of the contractor’s health and safety plan.

When EAG personnel are conducting tasks on their own, with or without subcontractors, they will follow the requirements of this HASP. EAG contractors, such as drillers, will also be required to follow the requirements of this HASP, as well as any more stringent requirements of the contractor’s health and safety plan.

All EAG field personnel, including subcontractors to EAG, will be required to read and understand this HASP and agree to implement its provisions. All site personnel will sign the Acknowledgement Form included in **Attachment A** stating that they have read, understood, and agree to abide by the guidelines and requirements set forth in this plan.

2.2 Organization of Document

This HASP includes health and safety procedures for all generally anticipated project field activities. This plan also meets the OSHA requirements contained in the CFR, specifically 29 CFR 1910.120 and 29 CFR 1926, by including the following items:

- A description of staff organization, qualifications and responsibilities (Section 2.3),
- Hazard analysis (Section 3.0),
- Health hazard information (Section 4.0),
- Personal protective equipment (PPE), including available first aid, emergency, and safety equipment (Section 5.0),
- Employee and subcontractor training and standard safety procedures (section 6.0),
- Exposure monitoring plan (Section 7.0),
- Medical surveillance (Section 8.0),
- Site control measures and decontamination procedures for personnel and equipment (Section 9.0),
- Emergency response and contingency procedures (section 10.0), and
- Material Safety Data Sheets (MSDSs) for chemicals used on-site (**Attachment B**).

2.3 EAG Health and Safety Personnel

Personnel responsible for implementing this HASP include:

EAG Contacts for Sparrows Point Project Work	
VP Remediation, Russ Becker	(314) 686-5611
Senior Project Manager, James Calenda	(314) 620-3056
Senior Project Engineer, Elizabeth Schlaeger	(314) 307-1732
Josh Burke – Field Operations Manager	(314) 686-5623
Project Field Team Members, Jeff Wilson and Bill Trentzsch	(314) 620-3135, (314) 686-5598

3.0 HAZARD ANALYSIS

This section outlines the potential hazards related to the field activities listed in Section 2.1.

3.1 Hazard Analysis

The field activities planned for this project pose potential health and safety hazards for field team members. This section describes the hazards associated with the above-listed field activities. Detailed chemical, physical, and biological hazards information is provided in Section 4.0 (Health Hazard Information).

Hazards to which employees and subcontractors may be exposed to as a result of the above-listed activities include potential chemical exposures, lacerations, excessive noise, thermal stress, lifting of excessive weight or bulk, hand tools and heavy equipment, drilling and slips, trips and falls.

3.1.1 Chemical Hazards

Potential exposures to chemicals in the soil or groundwater include the possibility of dermal exposure (contact and/or absorption), inhalation of chemical contamination that may be encountered during sampling or during equipment decontamination activities, or ingestion of contaminants if good personal hygiene practices are not followed.

Benzene, naphthalene, and various metals are the major contaminants that have been identified in groundwater during previous investigations at the site. In addition, light NAPL (LNAPL – benzene, in particular) and dense NAPL (DNAPL – naphthalene, in particular) have also been identified or are heavily suspected in various locations in the Coke Oven Area. Dissolved metals the chemicals of concern primarily located in the area of Tin Mill Canal and the Rod and Wire Mill Area. Treatment chemicals, such as sulfuric acid, are currently being used in remediation systems. All appropriate MSDS sheets will be reviewed that apply to the investigation or remedial tasks being conducted. MSDS sheets are located in **Attachment B**. It should be noted that this is a dynamic document: should any additional chemicals be introduced or discovered, the MSDS sheets will be added to **Attachment B**, as necessary.

3.1.2 Physical Hazards

The potential physical hazards associated with field activities include:

- Excessive lifting
- Slips, trips, and falls
- Working at heights
- Exposure to extreme outside temperatures and weather
- Equipment hazards
- Drilling Hazards
- Noise
- Dust and fumes
- Injury from tools, equipment, rotating parts
- Electrical hazards
- Buried and overhead hazards
- Work over water
- Driving to, from, and around the site (including working in trafficked areas)

Additional hazards may be encountered based on the various task at hand. It will be the responsibility of the site manager, with the help of field staff, to identify and address any additional hazards on a “per task or job” basis. A Job Safety Analyses (JSA) may need to be conducted prior to the start of various tasks. Safety meetings will be conducted with all staff in attendance, before the start of any new task or when any significant personnel or other changes (such as a swift change in weather, for example) occur. Updated information relating to physical hazards will be presented during these meetings in an effort to familiarize the crew with potential hazards, discuss new situations, and determine how the associated risks can be reduced. Further, good housekeeping practices will be enforced to preclude other risks resulting from clutter and inattention to detail. In addition, internal field audits will be randomly conducted to ensure adherence to all procedures are being followed.

3.1.3 Biological Hazards

Biological hazards that may be encountered when conducting field activities include the following:

- Poisonous snakes and spiders
- Ticks and tick-borne diseases
- Stinging insects such as chiggers, bees, wasps, etc.
- Various viruses and diseases spread via animal to human contact such as West Nile virus or rabies
- Various viruses and diseases spread via human to human contact such as colds or the flu
- Dermal contact with poison ivy, oak, and/or sumac
- Bloodborne pathogens when administering first aid

First aid kits will be available on-site. It is crucial to note that any site personnel who has significant allergies should communicate that information to the field team they are working with, along with the location of their auto-injector pen (such as an Epi-Pen) for use in case of going into anaphylactic shock from something that would cause such a reaction (like a bee sting, for example). Personnel who suffer from such allergies are responsible for providing their own auto-injector devices as those are typically prescription based as well as specific to their particular allergy.

4.0 HEALTH HAZARD INFORMATION

This section provides chemical hazard information for those potentially hazardous materials expected to be present at the facility. Potential physical and biological hazards are also discussed in this section.

4.1 Chemical Hazards

Exposure to chemicals through inhalation, ingestion, or skin contact may result in health hazards to field workers. Hazards associated with exposure will be evaluated using OSHA Permissible Exposure Limits (PELs) and the American Conference of Governmental Industrial Hygienists (ACGIH) Threshold Limit Values (TLVs). Each of these values are 8-hour, time-weighted averaged (TWAs) above which an employee cannot be exposed. EAG may also use the National Institute of Occupational Safety and Health (NIOSH) Recommended Exposure Limits (RELs) where applicable. Although the OSHA PELs are the only exposure limits enforceable by law, the most stringent of exposure limits will be used as the EAG-enforced exposure criteria during field activities.

The following is a summary of the potential hazards created by the compounds that may be encountered during field activities. Data from sampling of groundwater wells was reviewed to identify potential contaminants at the site. Contaminants of concern may include benzene, toluene, ethylbenzene and xylenes (BTEX), polycyclic aromatic hydrocarbons (PAHs), phenols, metals and water treatment chemicals. Table 4-1 contains chemical information and exposure limits for various chemicals that may be expected to be present in the investigation and remediation efforts. During the recovery of NAPL, the major contaminants of concern are benzene and naphthalene. It is possible that carbon monoxide may also be encountered from the use of various internal combustion engines (vehicular or otherwise); however, it is anticipated that since any such engine will be used outdoors, it is not expected that concentrations of concern will accumulate. With the use of any such engine, the engine should be positioned such that site personnel are upwind of the engine exhaust.

If any chemicals are brought on-site, MSDS must be made available and added to **Attachment B**. Personnel must be trained in the hazards and use of chemicals.

**Table 4-1
Chemical Contaminants of Potential Concern**

Chemical Name Synonyms (trade name)	Exposure Limits	Characteristics	Route of Exposure	Symptoms of Exposure
Benzene	PEL: 1PPM REL: 0.1 CA TLV: 0.5PPM STEL: 1PPM (NIOSH) Skin: YES	Colorless to light-yellow liquid with aromatic odor. LEL: 1.2% UEL: 7.8% VP: 75mm Fl.P: 12°F	INH ABS ING CON	Irritation of eyes, skin, nose, respiratory system, giddiness, headache, nausea, fatigue, anorexia, dermatitis, bone marrow depression
Ethylbenzene	PEL: 100PPM REL: 100PPM TLV: 100PPM STEL: 125PPM IDLH: 800PPM Skin: NO	Colorless liquid with an aromatic odor. LEL: 0.85 UEL: 6.7% IP: 8.76EV VP: 7mm Fl.P: 55°F	INH ING CON	Irritation of eyes, skin, mucous membranes; headache; dermatitis
1,1 dichloroethane	PEL: 100PPM REL: 100PPM TLV: 100PPM STEL: NA IDLH: 3000PPM Skin: NO	Colorless, oily liquid with a chloroform-like odor. LEL: 6.2% UEL: 16% IP: 11.05EV Vp: 64mm Fl.P: 56°F	INH ING CON	Irritation of eyes, CNS depression, liver, kidney, lung damage
Phenol	PEL: 5PPM REL: 5PPM, 15.6PPM (C) TLV: 5PPM STEL: NA IDLH 250PPM Skin: YES	Colorless to light pink crystalline solid with a sweet, acrid odor. LEL: 1.8% UEL: 5.9% IP: 8.12EV Vp: 0.08mm Fl.P: 175°F	INH ING CON ABS	Irritated eyes, nose, throat, anorexia, weakness, muscular ache, pain, dark urine, cyanosis, liver, kidney damage, skin burns, dermatitis, tremor, convulsions, twitch
Naphthalene	PEL: 10PPM REL: 10PPM TLV: 10PPM STEL: 15PPM IDLH: 250PPM Skin: YES	Colorless to brown solid with an odor of mothballs LEL: 0.9% UEL: 5.9% IP: 8.12EV Vp: 0.08mm Fl.P: 174°F	INH ABS ING CON	Irritation of eyes, headache, confusion, excitement, malaise, nausea, vomiting, abdominal pain, irritated bladder, profuse sweating, jaundice, hematuria, renal shutdown, dermatitis, optical neuritis, corneal damage
Toluene	PEL: 200PPM, 300PPM (C) REL: 100PPM TLV: 20PPM STEL: 150PPM IDLH: 500PPM Skin: YES	Colorless liquid with a sweet, pungent benzene-like odor. LEL: 1.1% UEL: 7.1% IP: 8.82EV VP: 21MM Fl.P: 40°F	INH ABS ING CON	Irritation of eyes, nose, fatigue, weakness, confusion, euphoria, dizziness, headache, dilated pupils, lacrimation, nervousness, muscle fatigue, insomnia, dermatitis, liver, kidney damage
Xylenes	PEL: 100PPM REL: 100PPM TLV: 100PPM STEL: 150PPM IDLH: 900PPM Skin: NO	Colorless liquid with an aromatic odor. LEL: 0.9% UEL: 6.7% IP: 8.40EV VP: 5MM Fl.P: 88°F	INH ABS ING CON	Irritated eyes, nose, respiratory system, headache, fatigue, dizziness, confusion, malaise, drowsiness, incoherence, staggering gait, corneal vacuolization, anorexia, nausea, vomiting, abdominal pain, dermatitis

Chemical Name Synonyms (trade name)	Exposure Limits	Characteristics	Route of Exposure	Symptoms of Exposure
Styrene	PEL: 100PPM, 200PPM (C) REL: 50PPM TLV: 20PPM STEL: 40PPM IDLH: 700PPM Skin: NO	Colorless to yellow, oily liquid with a sweet, floral odor. LEL: 0.9% UEL: 6.8% IP: 8.40eV VP: 5MM F.I.P: 88°F	INH ABS ING CON	Irritated eyes, nose, respiratory system, headache, fatigue, dizziness, confusion, malaise, drowsiness, weakness, narcosis, dermatitis
Chlorodiphenyl (54% chlorine) (11097-69-1)	PEL: 0.5mg/m ³ REL: 0.001mg/m ³ TLV: 0.5mg/m ³ STEL: N/A IDLH: 5mg/m ³ (CA) Skin: YES	Colorless to pale yellow viscous liquid with a mild hydrocarbon odor. LEL: NA UEL: NA IP: UNKNOWN VP: 0.00006MM F.I.P: NA	INH ABS ING CON	Irritated eyes, chloracne, liver damage, reproductive effects (carcinogen)
Polynuclear aromatic hydrocarbons (PAHs) (coal tar pitch volatiles) (65996-93-2)	PEL: 0.2mg/m ³ REL: 0.1mg/m ³ TLV: 0.2 mg/m ³ STEL: N/A IDLH: 80mg/m ³ (CA) Skin: NO	The pitch of coal tar is black or dark brown amorphous residue that remains after the redistillation process. LEL: N/A UEL: N/A IP: VARIES VP: VARIES F.I.P: VARIES	INH CON	Direct contact or exposure to vapors may be irritating to the eyes. Direct contact can be highly irritating to the skin and produce dermatitis. Exposure to vapors may cause nausea and vomiting. A potential human carcinogen.
Arsenic (inorganic)	PEL: 0.01mg/m ³ REL: NONE TLV: 0.5 mg/m ³ STEL: N/A IDLH: 5mg/m ³ (CA) Skin: NO	Silver-gray or tin-white brittle odorless solid. Air odor threshold: N/D.	INH ABS CON ING	Symptoms include ulceration of nasal septum, gastrointestinal disturbances, respiratory irritation and peripheral neuropathy. Potential occupational carcinogen.
Barium	PEL: 0.5mg/m ³ REL: 0.5mg/m ³ TLV: 0.5mg/m ³ STEL: N/A IDLH: 50mg/m ³ Skin: NO	White, odorless solid. Air odor threshold: N/D.	INH ING CON	Irritated eyes, skin, upper respiratory system, skin burns, gastroenteritis, muscle spasm, slow pulse, cardiac arrhythmia
Cadmium (elemental)	PEL: 0.005mg/m ³ REL: CA TLV: 0.01mg/m ³ STEL: N/A IDLH: 9mg/m ³ (CA) Skin: NO	Silver-white, blue-tinged lustrous, odorless solid. Air odor threshold: N/D.	INH ING	Symptoms include pulmonary edema, cough, tight chest, head pain, chills, muscle aches, vomiting and diarrhea. Potential occupational carcinogen.
Chromium (Metal)	PEL: 1.0mg/m ³ REL: 0.5mg/m ³ TLV: 0.5mg/m ³ STEL: N/A IDLH: 250mg/m ³ Skin: NO	Blue-white to steel-gray lustrous, brittle, hard odorless solid. Air odor threshold: N/D.	INH ING CON	Symptoms may include irritated eyes and skin, lung fibrosis.
Chromium (Chromium III inorganic compounds)	PEL: 0.5mg/m ³ REL: 0.5mg/m ³ TLV: 0.5mg/m ³ STEL: N/A IDLH: 25mg/m ³ Skin: NO	Varies depending on specific compound.	INH ING CON	Irritation of eyes, sensitivity dermatitis

Chemical Name Synonyms (trade name)	Exposure Limits	Characteristics	Route of Exposure	Symptoms of Exposure
Copper	PEL: 1mg/m ³ REL: 1mg/m ³ TLV: 1mg/m ³ STEL: N/A IDLH: 100mg/m ³ Skin: NO	Reddish, lustrous, malleable, odorless solid	INH ING CON	Irritation of eyes, nose, pharynx, nasal septum perforations, metallic taste, dermatitis
Lead (Elemental & Inorganic as Pb)	PEL: 0.05mg/m ³ RELO.1mg/m ³ TLV: 0.05mg/m ³ STEL: N/A IDLH: 100mg/m ³ Skin: NO	A heavy, ductile soft gray solid. Air odor threshold: N/D.	INH ING CON	Accumulative poison may cause weakness, insomnia, facial pallor, anorexia, malnutrition, constipation, abdominal pain, anemia, gingival lead line, paralysis of wrists and ankles, hypertension and kidney disease.
Nickel	PEL: 1mg/m ³ REL: 0.015mg/m ³ (Ca) TLV: 0.1mg/m ³ STEL: N/A IDLH: 10mg/m ³ Skin: NO	Lustrous, silvery, odorless solid. Air odor threshold: N/A VP: 0mm	INH CON ING	Sensitivity dermatitis, allergic asthma, pneumonitis
Vanadium pentoxide dust	PEL: 0.5mg/m ³ (C) REL: 0.05mg/m ³ (C) TLV: 0.05mg/m ³ STEL: N/A IDLH: 35mg/m ³ Skin: NO	Yellow-orange powder or dark gray, odorless flakes dispersed in air. VP: 0mm	INH ING CON	Irritated eyes, skin, throat, green tongue, metallic taste, eczema, cough, fine rales, wheezing, bronchitis
Zinc oxide	PEL: 5mg/m ³ REL: 5mg/m ³ TLV: 2mg/m ³ STEL: 10mg/m ³ IDLH: 500mg/m ³ Skin: NO	White, lustrous solid	INH	Metal fume fever, chills, muscular ache, nausea, fever, dry throat, cough, weakness, metallic taste, headache, blurred vision, low back pain, vomiting, fatigue, malaise
Sulfuric Acid (water treatment chemical)	PEL: 1mg/m ³ TLV: 0.2mg/m ³ Skin: YES	Oily, colorless to slightly yellow, clear to turbid liquid	IHN ABS ING CON	Can cause irritation or corrosive burns to the upper respiratory system, lung irritation, pulmonary edema, burns to mouth throat and stomach, erode teeth, skin lesions
Antiscale (water treatment chemical)	PEL: 1mg/m ³ TLV: 0.2mg/m ³ Skin: YES	Liquid, colorless, clear	IHN ABS ING CON	May cause severe skin burns and eye damage, can cause cancer, fatal if inhaled, may damage organs through prolonged exposure
Antifoam (water treatment chemical)	N/E	Liquid emulsion, white, opaque	IHN ABS ING CON	May be harmful to skin, if inhaled and if swallowed
Gases				
Carbon Monoxide	PEL: 50PPM REL: 35PPM TLV: 25PPM STEL: 200PPM (C) IDLH: 1200PPM Skin: NO	Colorless, odorless gas LEL: 12.5% UEL: 74% IP: 14.01eV VP: >35atm FI.P: N/A	INH	Headache, rapid breathing, nausea, tiredness, dizziness, confusion

NOTES:

OSHA PEL	Occupational Safety and Health administration Final Rule Limits, Permissible Exposure Limit for an eight-hour, time-weighted average
ACGIH TLV	American Conference of Governmental Industrial Hygienists, Threshold Limit Value for eight-hour, time-weighted average
STEL	Short-term Exposure Limit for a 15-minute, time-weighted average
NIOSH IDLH	National Institute for Occupational Safety and Health, Immediately Dangerous to Life or Health concentration
PPM	Part of vapor or gas per millions parts of air by volume at 25°Celsius and 760mm Hg mg/m ³ (milligram of substance per cubic meter of air)
CA	NIOSH has identified numerous chemicals that it recommends to be treated as potential or confirmed human carcinogens.
(C)	The (ceiling) concentration that should not be exceed during any part of the working exposure.
Skin	Refers to the potential contribution to the overall exposure by the cutaneous (absorption) route, including mucous membranes and eye, either by airborne or more particularly by direct contact with the substance.
UEL	Upper Explosive Limit – the highest concentration of a material in air that produces an explosion in fire or ignites when it contacts an ignition source.
LEL	Lower Explosive Limit – the lowest concentration of the material in air that can be detonated by spark, shock, fire, etc.
INH	Inhalation
ABS	Skin absorption
ING	Ingestion
CON	Skin and/or eye contact

4.2 Physical Hazards

Field employees and subcontractors may be exposed to a number of physical hazards during this project. Physical hazards that may be encountered include the following:

- Heat and cold stress
- Lifting hazards
- Slips, trips and falls
- Working around heavy equipment
- Drilling hazards
- Noise
- Use of hand and power tools
- Buried hazards
- Electrical hazards
- Underground and overhead utilities
- Working over water
- Travel to and from site

4.2.1 Heat Stress

Local weather conditions may produce an environment that will require restricted work schedules in order to protect employees from heat stress. The Project Manager or the Field Lead Team Member will observe workers for any potential symptoms of heat stress. Adaptation of work schedules and training on recognition of heat stress conditions should help prevent heat-related illnesses from occurring. Heat stress controls will be stated at 70°F for personnel in protective clothing and at 90°F for personnel in regular work clothing. Heat stress prevention controls include:

- Allow workers to become acclimatized to heat (three to six days)
- Provide rest breaks in a shaded or air-conditioned break area
- Provide sun screen to prevent sun burn
- Provide drinking water and electrolyte-replenishing fluids
- Keep ice readily available to rapidly cool field team members

The following Heat Stress Index should be used as a guide to evaluate heat stress situations. If the Heat Stress exceeds 105 degrees Fahrenheit, contact the project manager prior to conducting work for detailed guidance.

Heat Stress Index									
Temp. °F	Relative Humidity								
	10%	20%	30%	40%	50%	60%	70%	80%	90%
105	98	104	110	120	132				
102	97	101	108	117	125				
100	95	99	105	110	120	132			
98	93	97	101	106	110	125			
96	91	95	98	104	108	120	128		
94	89	93	95	100	105	111	122		
92	87	90	92	96	100	106	114	122	
90	85	88	90	92	96	100	106	114	122
88	82	86	87	89	93	95	100	106	115
86	80	84	85	87	90	92	96	100	109
84	78	81	83	85	86	89	91	95	99
82	77	79	80	81	84	86	89	91	95
80	75	77	78	79	81	83	85	86	89
78	72	75	77	78	79	80	81	83	85
76	70	72	75	76	77	77	77	78	79
74	68	70	73	74	75	75	75	76	77

NOTES: Add 10° F when protective clothing is being used; Add 10° F when in direct sunlight

HSI Temp	Category	Injury Threat
Above 130° F	Extreme Danger	No work unless emergency exists. Contact Cardno ATC RSC and Corporate Risk Management Department prior to proceeding. Heat cramps or exhaustion likely, heat stroke possible if exposure is prolonged and there is physical activity.
105° to 130° F	Danger	Contact RSC prior to proceeding. Requires strict adherence to ACGIH Heat Stress Guidelines, including use of on-site WBGT equipment. Heat cramps or exhaustion likely, heat stroke possible if exposure is prolonged and there is physical activity.
90° to 105° F	Extreme Caution	Heat cramps or exhaustion likely, heat stroke possible if exposure is prolonged and there is physical activity.
80° to 90° F	Caution	Heat cramps or exhaustion likely, heat stroke possible if exposure is prolonged and there is physical activity.
Below 80° F	Normal Range	Typical conditions for time of year. Little or no danger under normal circumstances. As always, anticipate problems and work safely.

4.2.2 Cold Stress

Frostbite and hypothermia are two types of cold injury that personnel must be protected against during the performance of field duties. The objective is to prevent the deep body temperature from falling below 96.8° F and to prevent cold injury to body extremities. Two factors influence the development of a cold injury the ambient temperature, and wind velocity. Reduced body temperature will very likely result in reduced mental alertness, reduction in rational decision making, and/or loss of consciousness with the threat of death.

-

Use appropriate cold weather clothing when temperatures are at or below 40° F as exposed skin surfaces must be protected. These protective items can include facemask, hand wear, and foot wear. Workers handling evaporative solvents during cold stress conditions will take special precautions to avoid soaking gloves and clothing because of the added danger of prolonged skin contact and evaporative cooling. Personnel will wear protective clothing appropriate for the level of cold and planned physical activity. The objective is to protect all parts of the body, with emphasis on the hands and feet. Eye protection against glare and ultraviolet light should be worn in snowy and icy conditions.

The work rate should not be so great as to cause heavy sweating that could result in wet clothing. If heavy work must be done, opportunities for rest breaks will be provided where workers have the opportunity to change into dry clothing. Conversely, plan work activities to minimize time spent sitting or standing still. Rest breaks should be taken in a warm, dry area. Windbreaks can also be used to shield the work area from the cooling effects of wind.

If extreme cold-related weather conditions occur, EAG field personnel and subcontractors will take the following precautions:

- Wear adequate insulated clothing when the air temperature drops below 40°F
- Reduce work periods in extreme conditions to allow adequate rest periods in a warm area
- Change clothes when work clothes become wet
- Avoid caffeine (which has diuretic and circulatory effects)

4.2.3 Lifting Hazards

Field personnel may be exposed to injury caused by lifting heavy objects and various pieces large or unwieldy pieces of equipment. All field team members will be trained in the proper methods for lifting heavy and/or large equipment and are cautioned against lifting objects that are too heavy or too big for one person. Proper lifting techniques include the following:

- Keep feet approximately shoulder width apart
- Bend at the knees
- Tighten abdominal muscles
- Lift with the legs
- Keep the load close to the body
- Keep the back upright
- Use the buddy system for larger or heavy pieces of equipment

All drums will be staged using an approved drum dolly or other appropriate equipment. Proper care will be taken in the use of this equipment. Healthy employees with no medical restrictions may lift and carry a maximum of 50 pounds using proper lifting and carrying techniques. This recommended weight limit may be reduced depending on physical and workplace factors.

4.2.4 Slips, Trips and Falls

The most common hazards that will be encountered during field activities will be slips, trips and falls. Field team members are trained to use common sense to avoid these hazards such as using work boots/safety shoes with nonskid soles. When working on slippery surfaces, tasks will be planned to decrease the risk of slipping via avoiding the slippery areas, if possible, or utilizing engineering controls. Engineering controls may involve the placement of supplemental material such as boards, gravel, or ice melt should be utilized to mitigate slippery conditions. Other engineering controls may involve the use of footgear traction control devices. Employees and subcontractors will avoid slippery surfaces, use engineering controls as appropriate, not hurry, and maintain good housekeeping.

4.2.5 Buried Hazards

Whenever the ground is penetrated, the potential for contacting buried hazards exists. During the planning/mobilization phase, prior to drilling or other excavation activities, EAG personnel and/or their contractors will establish the location of underground utility lines (gas, electrical, telephone, fiber optic cable, etc.) and/or substructures or other potential buried hazardous items. This may be conducted by review of historic utility and substructure maps, private utility locates, ground penetrating radar, or other technologies. If there is any evidence of utilities or subsurface objects/structures, drilling or excavation activities may be offset. If activities cannot be offset, measures will be taken to remove, disconnect, and/or protect the utilities and/or subsurface structures and/or objects. Every reasonable effort will be made to clear the area of intrusive work prior to fieldwork being started.

4.2.6 Electrical Hazards

It may be possible that overhead power lines will be in proximate locations during drilling or excavation activities. At least a 20 foot clearance must be maintained from overhead power lines. No equipment such as drill rigs or dump trucks can be moved while masts or buckets are in the upright position. Field personnel and subcontractors performing electrical work are required to be appropriately trained to work on the electrical systems in question prior to start of work. Authorization from project management personnel is required prior to any electrical work or work near overhead power lines. . When using extension cords, all field workers will ensure that they are in good working condition, are correctly rated for use, and do not contain abrasions such that bare wires could be exposed to the environment. Extension cords will not be used in wet areas without plugging the extension cord into a ground fault circuit interrupter (GFCI). GFCIs will detect a short circuit and cut power.

4.2.7 Heavy Equipment Operations

Heavy equipment must be operated in a safe manner and be properly maintained such that operators and ground personnel are protected.

Requirements for Operators

- Only qualified, trained, and authorized operators are allowed to operate equipment
- Seat belts will be used at all times in all equipment and trucks
- Operators will stop work whenever ground personnel or other equipment enter their work area; work will resume only when the area has been cleared
- No personnel may ride on equipment other than the Authorized Operator
- No personnel may be carried or lifted in the buckets or working “arms” of the equipment
- Spotters will be used when ground personnel are in the vicinity of heavy equipment work areas and/or when an operator is backing equipment near other structures or congested area

Requirements for Ground Personnel

- All ground personnel must wear orange protective vests in work areas with any operating heavy equipment
- Ground personnel will stay outside of the swing zone or work area of any operating equipment
- Ground personnel may only enter the swing or work area of any operating equipment when:
 - They have attracted the operators attention and made eye contact
 - The operator has idled the equipment down and grounded all extensions
 - The operator gives the ground personnel permission to approach
- Ground personnel shall never walk or position themselves between any fixed object and running equipment or between two running pieces of equipment

Equipment

- Maintain operations manuals at the site for each piece of equipment that is present and in use
- Ensure operators are familiar with the manual for the equipment and operate the equipment within the parameters of the manual
- Ensure all equipment is provided with roll-over protection systems
- Verify that seatbelts are present and functional in all equipment
- Prohibit the use of equipment that has cab glass which is broken or missing
- Ensure that backup alarms are functional on all trucks and equipment
- Require all extensions such as buckets, blades, forks, etc. to be grounded when not in use
- Require brakes to be set and wheels chocked (when applicable) when not in use

Daily inspections of equipment are required using a Daily Heavy Equipment Safety Checklist. Equipment deemed to be unsafe as a result of daily inspection will not be used until required repairs or maintenance occurs. During maintenance/repair, ensure that motors are turned off, all extensions are grounded or securely blocked, controls are in a neutral position, and the brakes are set.

4.2.8 Drilling and Excavation Safety

Prior to any intrusive work, as previously mentioned, the location of underground utilities, such as sewer, telephone, gas, water and electric lines must be determined and plainly staked. Necessary arrangements must be made with the utility company or owner for the protection, removal or relocation of the underground utilities. In such circumstances, excavation will be done in a manner that

does not endanger the field personnel engaged in the work or the underground utility. Utilities left in place will be protected by barricading, shoring, suspension or other measures, as necessary.

The use of unsafe or defective equipment is not permitted. Equipment must be inspected regularly. If found to be defective, equipment must be immediately removed from use and either repaired or replaced prior to resuming work with that equipment. Field personnel will be familiar with the location of first-aid kits and fire extinguishers. Telephone numbers for emergency assistance must be prominently posted and kept current.

Good housekeeping conditions will be observed in and around the work areas. Suitable storage places will be provided for all materials and supplies. Pipe, drill rods, etc. must be securely stacked on solid, level sills. Work surfaces, platforms, stairways, walkways, scaffolding, and access ways will be kept free of obstructions. All debris will be collected and stored in piles or containers for removal and disposal.

The area of the site to undergo intrusive activity must be walked over with the drillers and/or heavy equipment operators to identify all work locations, as well as making sure all marked utilities are seen by those doing the intrusive work.

Drilling Specific Concerns:

In areas where utilities have been identified or may be suspected, pre-drilling clearance such as hand-augering, hand excavation (with shovels or post-hole diggers), or air-knifing to a depth of at least 5' below ground surface (BGS) may be required. The Project Manager will provide guidance in those instances on what has been determined as an acceptable means of clearing drilling locations. It should be noted that if the soil lithology changes to gravel within those 5 feet, that may be an indication of a utility trench and extreme caution should be taken OR the drilling location should be offset 5 horizontal feet from the original location. Should 3 consecutive attempts be made without success to offset a particular drilling location, the field personnel should stop and contact the Project Manager for further instruction.

Special precaution must be taken when using a drill rig on a site within the vicinity of electrical power lines and other overhead utilities. Electricity can shock, burn and cause death. When overhead electrical power lines exist at or near a drilling site, all wires will be considered dangerous.

A check will be made for sagging power lines before a site is entered. Power lines will not be lifted to gain entrance. The appropriate utility company will be contacted and a request will be made that it lift or raise cut off power to the lines.

The area around the drill rig will be inspected before the drill rig mast (derrick) is raised at a site in the vicinity of power lines. The minimum distance from any point on the drill rig to the nearest power line will be determined when the mast is raised or is being raised. The mast will not be raised and the drill rig will not be operated if this distance is less than 20 feet, because hoist lines and overhead power lines can be moved toward each other by the wind.

Before the mast is raised, personnel will be cleared from the immediate area, with the exception of the operator and a helper, when necessary. A check will be made to ensure safe clearance from energized power lines or equipment (minimum 20-foot clearance). Unsecured equipment must be removed from the mast and cables, mud lines and catline ropes must be adequately secured to the mast before raising. After it is raised, the mast must be secured to the rig in an upright position with steel pins.

Excavation Specific Concerns:

For excavation work, entry into an excavated area or trench will only be allowed when:

- Shoring, sloping, and spoil pile placement is in conformance with 29 CFR 1926 Subpart P, and
- Personal protection and monitoring, as detailed in this HASP, has been implemented.

All excavation contractors are required to provide an OSHA trained and certified Competent Person. Daily inspections of excavations, the adjacent areas, and protective systems shall be made by the Competent Person for evidence of a situation that could result in a possible cave-in, indications of failure of protective systems, hazardous atmospheres, or other hazardous conditions. An inspection shall be conducted by the Competent Person prior to the start of work and as needed throughout each shift. Inspections shall also be made after every rainstorm or other hazard increasing occurrence. All inspections made by the Competent Person should be recorded in the field log book. No personnel shall perform work in a trench or excavation that contains accumulated water (any accumulated water will need to be either pumped out until the trench/excavation is dry, or the accumulated water is allowed to disperse naturally). Each employee in an excavation shall be protected from cave-ins by an adequate protective system except when excavations are made entirely in stable rock or the excavation is less than 5 feet in depth and examination by the Competent Person provides no indication of a potential cave-in. Protective systems consist of sloping or benching, use of trench boxes or other shielding mechanisms, or the use of a shoring system in accordance with the regulations.

When mobile equipment is operated adjacent to an excavation and the operators/drivers do not have a clear and direct view of the edge of the excavation, a warning system such as barricades, hand or mechanical signals, or spotters are required.

Adequate protection shall be provided to protect employees from loose rock or soil that could pose a hazard to personnel in the excavation. All temporary spoil piles shall be kept at least 2 feet away from the edge of the excavation. Spoil piles should be placed to channel rainwater or other run-off water away from the excavation.

All excavations deeper than 4 feet deep and which have the potential to have a hazardous atmosphere or oxygen deficient atmospheres (less than 19.5% oxygen) must be tested to ensure safe working conditions, prior to entry.

4.2.9 Use of Hand Tools and Portable Power Tools

Hand tools will be kept in good repair and used only for their designed purposes. Proper protective eyewear will be worn when using hand tools and portable power tools. Unguarded sharp-edged or

pointed tools will not be carried in field personnel's pockets. The use of tools with mushroomed heads, split or defective handles, worn parts, or other defects will not be permitted. Inspect all tools prior to start-up or use to identify any defects. Tools that have become unsafe will be reconditioned before reissue or they will be discarded and replaced. Throwing or dropping of tools from one level to another will not be permitted; rather, containers and hand lines will be used for transporting tools from one level to another if working at heights.

Non-sparking tools will be used in atmospheres where sources of ignition may cause fire or explosion. Electric-powered shop and hand tools will be of the double-insulated, shockproof type, or they will be effectively grounded. Power tools will be operated only by designated personnel who are familiar and trained with their use. When not in use, tools will not be left on scaffolds, ladders or overhead working surfaces.

4.2.10 Noise

Exposure to high levels of noise may occur when working near drill rigs or other heavy equipment. Also, depending upon where the work is being performed, local equipment (e.g., airports, factory machines, etc.) may produce high levels of noise. A good indication of the need for hearing protection is when verbal communication is difficult at a distance of 2-3 feet. Personnel will be provided with ear plugs and/or earmuffs when exposed to noise levels in excess of the 8-hour Permissible Exposure Limit (PEL) of 90 decibels.

4.2.11 Work Zone Traffic Control

Personnel will exercise caution when working near areas of vehicular traffic. Work zones will be identified by the use of delineators (traffic cones, flags, vehicles, DOT approved devices, temporary or permanent fencing, and/or safety barrier tape). Personnel will wear reflective vests when working in these areas. Depending on frequency, proximity, and nature of traffic, a flag person may also be utilized.

4.2.12 Work Over Water

If personnel will be working near, above or immediately adjacent to or within 6 feet of water that is 3 feet or more deep or where water presents a drowning hazard (e.g., fast-moving stream, water body with a soft bottom), employees are required to a U.S. Coast Guard (USCG) approved personal flotation device (PFD). All PFDs must have reflective tape on them to facilitate visibility. Employees must inspect PFDs daily before use for defects. Do not use defective PFDs.

4.2.13 Vehicle Use

Personnel must use caution when driving to, from, and across the site, paying special attention to other site traffic, as well as weather and road conditions. Heavy equipment should be transported during non-rush hour traffic.

4.3 Biological Hazards

Site activities on this Site may expose workers to other hazards such as poisonous plants, insects, animals, and indigenous pathogens. Protective clothing and respiratory protection equipment, and being capable of identifying poisonous plants, animals, and insects, can greatly reduce the chances of exposure. Thoroughly washing any exposed body parts, clothing, and equipment will also protect against infections. Avoiding contact with biological hazards is the best way to prevent potential adverse health effects. Recognition of potential hazards is essential. When avoidance is impractical or impossible, PPE, personal hygiene, good general health and awareness must be used to prevent adverse effects. If working in wooded/grassy areas, use appropriate insect repellants (containing DEET and/or Permethrin) and apply them per the manufacturers' directions. The following is a list of biological hazards that may be encountered while performing field activities at the project site and surrounding areas:

BIOLOGICAL HAZARD and LOCATION	CONTROL MEASURES
<p>Snakes typically are found in underbrush and tall grassy areas.</p>	<p>If you encounter a snake, stay calm and look around; there may be other snakes. Turn around and walk away on the same path you used to approach the area. If a person is bitten by a snake, wash and immobilize the injured area, keeping it lower than the heart if possible. Seek medical attention immediately. DO NOT apply ice, cut the wound or apply a tourniquet. Carry the victim or have him/her walk slowly if the victim must be moved. Try to identify the snake: note color, size, patterns and markings.</p>
<p>Poison ivy, poison oak and poison sumac typically are found in brush or wooded areas. They are more commonly found in moist areas or along the edges of wooded areas.</p>	<p>Become familiar with the identity of these plants. Wear protective clothing that covers exposed skin and clothes. Avoid contact with plants and the outside of protective clothing. If skin contacts a plant, wash the area with soap and water immediately. If the reaction is severe or worsens, seek medical attention.</p>
<p>Exposure to bloodborne pathogens may occur when rendering first aid or CPR, or when coming into contact with medical or other potentially infectious material or when coming into contact with landfill waste or waste streams containing such infectious material.</p>	<p>Training is required before a task involving potential exposure is performed. Exposure controls and personal protective equipment (PPE) area required. Hepatitis B vaccination must be offered before the person participates in a task where exposure is a possibility.</p>
<p>Bees, spiders and other stinging insects may be encountered almost anywhere and may present a serious hazard particularly to people who are allergic.</p>	<p>Watch for and avoid nests. Keep exposed skin to a minimum. Carry a kit if you have had allergic reactions in the past and inform the Project Manager and/or the buddy. If a stinger is present, remove it carefully with tweezers. Watch for allergic reaction; seek medical attention if a reaction develops.</p>
<p>Ticks typically are in wooded areas, bushes, tall grass and brush. Ticks are black, black and red or brown and can be up to one-quarter inch in size.</p>	<p>Avoid tick areas. Wear tightly woven, light-colored clothing with pants tucked into boots or socks. Spray outside of clothing with insect repellent containing permethrin. Check yourself for ticks often. If bitten, carefully remove tick with tweezers. Report the bit to the Project Manager. Look for symptoms of Lyme</p>

	disease that include a rash that looks like a bulls eye and chills, fever, headache, fatigue, stiff neck or bone pain. If symptoms appear, seek medical attention.
--	--

5.0 PERSONAL PROTECTIVE EQUIPMENT

PPE ensembles are used to protect employees and subcontractors from potential contamination hazards while conducting project field activities. Level D is expected to be used for most activities at the site. The following subsections describe the PPE requirements for the field activities.

5.1 Level D Protection

When the atmosphere contains no known hazards and work functions preclude splashes, immersions or the potential for unexpected inhalation of or contact with hazardous levels of any chemicals, Level D protection may be used. Level D does not provide respiratory protection and only provides minimal dermal protection. The Level D ensemble consists of the following:

- Work clothes that may consist of a short or long-sleeved cotton shirt and cotton pants, cotton overalls, or disposal overalls such as Tyvek™
- Steel-toe/steel-shank work boots
- Safety glasses with side shields
- Hearing protection, as necessary
- Hand protection, as appropriate
- Hard hat when working around overhead equipment such as a drilling rig
- Reflective vests when working around heavy equipment or near roadways
- Body harness and life vests when working on or within 6 feet of bulkheads, at heights, or in 3 feet or more of standing water (such as in Tin Mill Canal)

5.2 Modified Level D Protection

This is the level of protection that may be needed for material handling, sampling operations, and operation of remediation equipment when splash hazards are present. Modified Level D protection consists of the following:

- Disposable overalls such as polyethylene-coated Tyvek™
- Latex, vinyl, or nitrile inner gloves when handling liquids/fluids
- Nitrile outer gloves (taped to outer suit)
- Chemical-protective over-boots (taped to outer suit)
- Steel-toe/steel-shank, high-ankle work boots
- Hard hat with face shield
- Safety glasses with side shields or goggles
-) U
- Hearing protection, as necessary

5.3 Level C Protection

Level C protection will be used when site action levels are exceeded and respiratory protection is required. The Level C ensemble consists of Modified Level D with the following modifications:

- Half or full-face air-purifying respirator (APR) equipped with appropriate cartridges/filters
- Chemical resistant clothing such as poly-coated Tyvek™
- Inner and outer nitrile gloves
- Chemical-resistant safety boots or boot covers to go over safety boots

Upgrading or downgrading the level of protection used by EAG employees and subcontractors is a decision made by EAG based on the air monitoring protocols presented in Section 7.0 for respiratory protection, the potential for inhalation exposure to toxic chemicals, and the need for dermal protection during the activity.

5.4 First Aid, Emergency and Safety Equipment

The following first aid, emergency and safety equipment will be maintained onsite at the work area:

- A portable eye wash
- Appropriate ABC-type fire extinguishers (minimum of 10 pounds; remediation systems to house individual 20 pound extinguishers) carried in every vehicle used during field operations
- Industrial first-aid kit (one 16-unit that complies with American National Standards Institute (ANSI) Z308A for every 25 persons or less)
- Bloodborne pathogen precaution kit with CPR mouth shield
- Instant cold packs
- Soap or waterless hand cleaner and towels
- American Red Cross First Aid and CPR Instruction Manuals

6.0 PERSONNEL TRAINING AND STANDARD SAFETY PROCEDURES

Employees must have received, at the time of project assignment, a minimum of 40 hours of initial OSHA health and safety training for hazardous waste site operations. Personnel who have not met the requirements for the initial training will not be allowed in the Exclusion Zone (EZ) or Contamination Reduction Zone (CRZ) of any active work area. A copy of each subcontractor site worker's 40-hour training certificate must be sent to the Project Manager for review prior to the start of the site work.

The 8-hour refresher training course must be taken at a minimum of once per year. At the time of the job assignment, all site workers must have received 8 hours of refresher training within the past year. This course is required of all field personnel to maintain their qualifications for hazardous waste site work. A copy of each subcontractor site worker's most recent 8-hour refresher training certificate must be sent to the Project Manager for review prior to the start of the site work.

A site-specific safety orientation will be conducted by EAG for all EAG employees and subcontractors engaged in fieldwork.

6.1 Onsite Safety, Health and Emergency Response Training

The OSHA 1910.120 standard requires that site safety and health training be provided by a trained, experienced supervisor. “Trained” is defined to mean an individual that has satisfactorily completed the OSHA 40-hour Hazardous Waste Operations and Emergency Response (HAZWOPER) course and 8-hour site supervisor training. Training will be offered at the time of the initial task assignment and/or whenever new chemicals are introduced into the workplace. Training will include all applicable regulatory requirements, location of the program, inventory and MSDSs, chemicals used and their hazards (chemical, physical, and health), how to detect the presence or release of chemicals, safe work practices and methods employees can take to protect themselves from hazards, how to read MSDSs and site or project specific information on hazard warnings and labels in use at that location. All training will be documented and training certificates will be kept in the employee’s permanent training file. All applicable training will also require annual refreshers.

EAG qualified personnel must also provide safety meetings.

6.2 Standard Safety Procedures

This section describes the standard safety procedures that EAG requires all onsite personnel to follow during site activities.

6.2.1 General Safety Work Practices

All onsite employees and subcontractors will observe the following general safety work practices:

- Health and safety tailgate briefings will occur to introduce new activities, any new safety issues, and emergency egress routes for work areas; any significant change (added personnel, change in scope, or change in field conditions) will trigger a second (or more) tailgate meeting to address whatever change occurred
- No food, drink, or tobacco products will be allowed in the Exclusion and Contamination Reduction Zones
- Loose clothing, hair, and/or jewelry will not be permitted around moving or rotating equipment
- The “buddy system” will be implemented as necessary whereby a pair of co-workers watches out for each other while in proximity of potential physical work hazards
- Good housekeeping of all work areas will be maintained on an ongoing basis

6.2.2 Hand Safety

This standard is intended to protect employees from activities that may expose them to injury. This standard provides information on recognizing those conditions that require personal protective equipment (PPE) or specific work practices to reduce the risk of hand injury.

Appropriate gloves must be worn when persons work with materials or equipment that presents the potential for hand injury due to sharp edges, corrosives, flammable and irritating materials, extreme temperatures, splinters, etc.

Guidelines for Working With and Around Equipment (Hand Tools, Portable Powered Equipment):

- Employees should be trained in the use of all tools.
- Keep hand and power tools in good repair and use them only for the task for which they were designed.

- Inspect tools before use and remove damaged or defective tools from service.
- Operate tools in accordance with manufacturer's instructions.
- Do not remove or bypass a guarding device for any reason.
- Keep surfaces and handles clean and free of excess oil to prevent slipping.
- Wear proper PPE, including gloves, as necessary.
- Do not carry sharp tools in pockets.
- Clean tools and return to the toolbox or storage area upon completion of a job.
- Before applying pressure, ensure that wrenches have a good bite.
- Brace yourself by placing your body in the proper position so you will not fall if the tool slips.
- Make sure hands and fingers have sufficient clearance in the event the tool slips.
- Always pull on a wrench, never push.
- When working with tools overhead, place tools in a holding receptacle when not in use.
- Do not throw tools from place to place or from person to person, or drop tools from heights.
- Inspect all tools prior to start-up or use to identify any defects.
- Powered hand tools should not be capable of being locked in the ON position.
- Require that all power-fastening devices be equipped with a safety interlock capable of activation only when in contact with the work surface.
- Do not allow loose clothing, long hair, loose jewelry, rings, and chains to be worn while working with power tools.
- Do not use cheater pipes.
- Make provisions to prevent machines from restarting through proper lockout/tagout.

Guidelines for using Cutting Tools:

- Always use the specific tool for the task. Tubing cutters, snips, self-retracting knives, concealed blade cutters, and related tools are task specific and minimize the risk of hand injury. For more information about cutting tools, see Supplemental Information A.
- Fixed open-blade knives (FOBK) are prohibited from use. Examples of fixed open-blade knives include pocket knives, multitools, hunting knives, and standard utility knives.
- When utilizing cutting tools, personnel will observe the following precautions to the fullest extent possible:
 - Use the correct tool and correct size tool for the job.
 - Cut in a direction away from yourself and not toward other workers in the area.
 - Maintain the noncutting hand and arm toward the body and out of the direction of the cutting tool if it were to slip out of the material being cut.
 - Ensure that the tool is sharp and clean; dirty and dull tools typically cause poor cuts and more hazard than a sharp, clean cutting tool.
 - Store these tools correctly with covers in place or blades retracted, as provided by the manufacturer.
 - On tasks where cutting may be very frequent or last all day (e.g., liner samples), consider Kevlar® gloves in the PPE evaluation for the project.
 - Do not remove guards on paper cutters.

6.2.3 Respiratory Protection

Based on air monitoring, an upgrade to Level C protection may be indicated. Half or full-face APRs will be utilized for protection against organic vapors and particulates. All employees required to wear respirators will be need to be medically cleared, in writing to do so by a qualified Occupational Physician.

All respirator users must be trained before they are assigned a respirator, annually thereafter, whenever a new hazard or job is introduces and whenever employees fail to demonstrate proper use or knowledge. Training will include, at a minimum:

- Why the respirator is necessary and what conditions can make the respirator ineffective.
- What limitation and capabilities of the respirators area.
- How to inspect, put on and remove and check the seals of the respirator.
- What respirator maintenance and storage procedures are.
- How to recognize medicals signs and symptoms that may limit or prevent effective use of the respirator.
- The engineering and administrative controls being used and the need for respirators.
- The hazards and consequences of improper respirator use.
- How to recognize and handle emergency situations.

Training will be documented and training certificated will be kept in the employee's permanent training file.

6.2.4 Personal Hygiene Practices

The field team must pay strict attention to sanitation and personal hygiene requirements to avoid personal contamination. The following instructions will be discussed and must be followed:

- During field activities, never put anything in the mouth, including fingers
- All employees must wash their hands, forearms, face, and neck before eating drinking, smoking or using the restroom
- Smoking is prohibited except in designated areas outside the work zone
- At the end of the day, all employees will shower upon returning home or to their hotel

6.2.5 Electrical Safety

All extension cords used onsite must be heavy-duty variety and must be properly grounded. All temporary circuitry must incorporate the use of GFCI devices. Refer to electrical safety in Section 4.2.6, Electrical Hazards.

6.2.6 Fire Safety

All flammable liquids will be used only for their intended purpose and stored and handled only in approved containers. Portable containers must be the approved red safety containers equipped with flame arresters and self-closing lids. All transfers of flammable liquids must be made with the containers grounded or bonded. Also, gasoline containers will be clearly labeled and storage areas (if

applicable) will be posted with “No Smoking” signs. Fire extinguishers will be stalled in all areas that contain flammable liquids.

6.2.7 Illumination

All work is planned for daylight hours. No special requirements are anticipated. However, should any work take place outdoors after daylight hours, suitable lighting will be required. In addition, suitable lighting is to be provided in each remediation system building or enclosure.

6.2.8 Sanitation

Potable water and toilet facilities will be provided in compliance with the OSHA 1926.51 standard. Any container used to distribute drinking water shall be clearly marked and not used for any other purpose. Single drinking cups will be supplied, both a sanitary container for the unused cups and a receptacle for disposed of the used cups will also be provided. Port-a-johns will be provided since there are no sanitary sewers on the job site.

7.0 EXPOSURE MONITORING PLAN

This section describes air and personnel monitoring protocols, sampling methods, and instrumentation to be used, as well as the methods and frequency of sampling instrument calibration and action levels for potential work site hazards. When engaged in air monitoring, EAG personnel and subcontractors must use the forms to record air monitoring data and air monitoring instrument calibration records. All monitoring records/forms are to be maintained in the project file by the EAG Project Manager.

7.1 Air Monitoring

The surveillance program is established to detect changes in the ambient air at the work site and to ensure the continuing safety of the work zones and adequacy of the level of worker protection. During field activities, the designated field team member will monitor the work site for combustible gas concentrations and organic vapors. Calibration of all monitoring equipment will be performed in accordance with the manufacturers’ procedures by trained EAG employees and subcontractors. The Project Manager, Project Field Team Leader or representative will be notified immediately of any contaminant levels that could trigger an upgrade in PPE or cause a suspension of site activities.

- One or more of the following direct-reading instruments may be used to aid in this determination. Photoionization Detectors (PID) and Flame Ionization Detectors (FID) will measure non-specific organic gases and vapors. Combustible Gas Indicators (CGI) will detect explosive atmospheres. Oxygen (O₂) meters will detect fluctuations in oxygen concentrations. These instruments should be calibrated or bump tested daily and whenever the readings may be erratic. All readings should be recorded in the field log books.

Air monitoring results obtained from the breathing zone during field activities will be recorded in field log books. All such records will also include the location, date/time, weather conditions, person monitored, background concentration, and identification of specific contaminant whenever possible. Air monitoring information will be utilized to evaluate personnel exposure and assess the appropriateness of PPE for Site conditions.

7.1.1 Combustible Gas and Oxygen Deficiency/Excess Monitoring

Explosive gas concentrations are not expected to exceed 10% of the lower explosive level (LEL). Should the need be indicated for monitoring, action guidance for the CGI/O2 meter responses is contained in **Table 7-1**.

Table 7-1

CGI/Oxygen Meter Action Levels	
Meter Response	Action
CGI response 0%-10% LEL	Continue normal operations
CGI initial response >10% and <20% LEL	Eliminate all sources of ignition from the work area; temporarily retreat from work area for 15-30 minutes and then monitor area again
CGI response after 15-30 minute retreat >10% and <20% LEL	Retreat from work area; notify Project Manager
CGI response >20%	Discontinue operations; retreat from work area
Oxygen level <19.5%	Retreat from work area; notify Project Manager
Oxygen level >23.5%	Retreat from work area; notify Project Manager

7.1.2 Organic Vapor Concentrations

Real-time monitoring for organic vapor concentrations in the breathing zone and down hole will be conducted during field operations (installation of groundwater monitoring and groundwater sampling by EAG and EAG subcontractor personnel) with a PID equipped with a 10.2- or 11.7-electron volt (eV) probe. The PID will be taken into the field and operated during site activities where contaminated soil and/or groundwater may be present. Air monitoring will be conducted during well installation and when a well is opened for groundwater measurements. Measurements will be made at the well head and personnel breathing zones where activities are being performed. The instrument will be calibrated using ultra-high purity air and isobutylene vapor of known concentration before and after use each day. Air calibration measurements will be documented in writing and kept in the project file. Action guidance for PID responses is contained in **Table 7-2**.

Table 7-2

Action Levels for General Site Work	
Meter Response in Breathing Zone (minimum of 3 minutes)	Action Required
<5ppm above background	Use Level D PPE
>5ppm above background	Level C PPE, including half or full-face APR with organic vapor cartridges/P100 filters
>50ppm above background	Stop work
Action Levels for Handling NAPL	
Meter Response in Breathing Zone (minimum of 3 minutes)	Action Required
<1ppm above background	Use Modified Level D PPE
>1ppm to <10ppm	Level C PPE, including half or full-face APR with organic vapor cartridges
>10ppm above background	Immediately withdraw; monitoring will continue until action levels will allow safe re-entry

If air concentrations of organic vapors are greater than 5 ppm above background in the breathing zone for a 3-minute period, personnel will stop work, retreat from site, and allow time (at least 15 minutes) for vapors to dissipate. If monitoring indicates that concentrations still exceed 5 ppm, workers will upgrade to Level C PPE. If monitoring indicates that concentrations exceed 50 ppm, work will be stopped until site conditions can be re-evaluated.

These action levels are based on the assumption that the major component of free product being recovered will be benzene or naphthalene.

Work involving NAPL recovery from monitoring wells will be conducted in Level C PPE. This level may be downgraded based on air monitoring data and actual field conditions. Downgrading of PPE must be approved by the PM and HSE staff. If ventilation is conducted, additional air monitoring will be performed to the resumption of work to determine the level of PPE required.

7.2 Physical Conditions Monitoring

Site workers will be monitored by the Project Manager for signs of weather-related symptoms from exposure to excessive heat or cold.

Whenever the air temperature exceeds 70°F for personnel wearing chemical protective clothing or 90°F for personnel wearing regular work clothes, the Project Manager will assess conditions that may cause heat stress in site workers.

8.0 MEDICAL SURVEILLANCE

This section discusses the medical surveillance program, how the results are reviewed by a physician and how participation is documented.

8.1 Medical Surveillance Program

All personnel who will be performing any task where potential exposure to hazardous material exists will undergo medical surveillance as outlined in OSHA 29 CFR 1910.120(f). All personnel performing tasks in the Exclusion Zone or Contamination Reduction Zone will be required to have passed the EAG medical surveillance examination (or equivalent), performed by a licensed Occupational Physician. The Project Manager will verify that all EAG and subcontractor personnel meet applicable OSHA medical surveillance requirements.

Applicable field employees will undergo an annual comprehensive medical examination, including a comprehensive health history, blood chemistry with complete blood count and differential, urinalysis, medical history, required chest x-rays, audiogram, pulmonary function testing, testing for heavy metals (as needed), and a physician's interpretation of each employee's medical surveillance examination, including the ability of the employee to wear a respirator. A comprehensive medical examination will be performed if an employee develops signs or symptoms indicating possible overexposure to hazardous substances and/or heat or cold stress.

8.2 Physician Review

All medical surveillance and examination results are reviewed by a licensed physician who is certified in Occupational Medicine by the American Board of Preventive Medicine. EAG employee participation in the medical surveillance program is a part of their permanent medical record maintained in the employee's home office. A copy of the current medical clearance signed by the occupational health physician for all EAG employees must be maintained at the home office.

9.0 SITE CONTROL MEASURES AND DECONTAMINATION

To provide for the protection of public health and safety and minimize the possibility of transferring hazardous substances from the site, contamination control procedures are required. These procedures consist of site control measures (which entail the delineation of work zones, communications, and site security) and decontamination procedures (which are necessary for both personnel and equipment). Contaminants that may be uncovered during sampling operations must not be transferred outside the work zone unless properly containerized, and must be removed from clothing, personnel, and equipment prior to relocation from that zone. This section discusses site control measures and decontamination procedures to be used during the collection of samples, the installation of soil borings and/or groundwater monitoring/remediation wells, excavations, and other intrusive work where contact with impacted soils and groundwater could occur by EAG and/or EAG subcontractor personnel.

9.1 Site Control Measures

Site control can be achieved by effectively delineating the work zone, providing appropriate communication, and establishing site security.

9.1.1 Work Zone Delineation

To minimize the transfer of hazardous substances from the site and to ensure proper protection of employees and subcontractors, work zones will be established by the Field Project Team Leader. Applicable site work and the associated requirement for work zones will be determined by the Project Manager. The work area will be divided into an Exclusion Zone (EZ), a Contamination Reduction Zone (CRZ), and a Support Zone (SZ). A typical work zone delineation setup is shown as **Figure 9-1**, below.

Exclusion Zone (EZ)

Contamination does or could exist in this zone. Only properly authorized and trained individuals (refer to Section 6.0) wearing appropriate PPE will be allowed to enter and work in this zone. All people entering the EZ must wear, at a minimum, Level D protection. An entry and exit point for personnel and equipment will be established at the periphery of the EZ (between the EZ and the CRZ) to regulate the flow of personnel and equipment.

Contamination Reduction Zone (CRZ)

Between the EZ and the SZ will be the CRZ, which will provide a transition between the potentially contaminated EZ and the clean SZ. The CRZ (located upwind of the EZ, if possible) will be a corridor leading from the EZ and will serve as a buffer to further reduce the probability of the SZ becoming contaminated. Exit from the EZ will only be allowed through this CRZ. The CRZ will provide additional assurance that the physical transfer of contaminating substances on people, equipment, and/or in the air will be limited through a combination of decontamination and zone restrictions. Within this zone, employees and subcontractors may perform personal decontamination (e.g., face and hand washing), and certain PPE and small equipment decontamination. Buckets or wash basins for boot

washing and equipment decontamination will be stationed on a sheet of plastic (a minimum of 8 feet by 8 feet), the boundaries of which will constitute the CRZ.

Support Zone (SZ)

The Support Zone will be considered a non-contaminated area. The location of support facilities in the SZ will be upwind of the EZ (where possible) and readily accessible to the nearest road. The field office/support facilities, equipment vehicles, a first aid station and a visitors/personnel entry and exit log for the work site will be located in this zone. Potentially contaminated personal clothing, equipment and samples are not permitted in this zone unless properly containerized.

**Figure 9-1
Typical Exclusion, Contamination Reduction, and Support Zone setups**

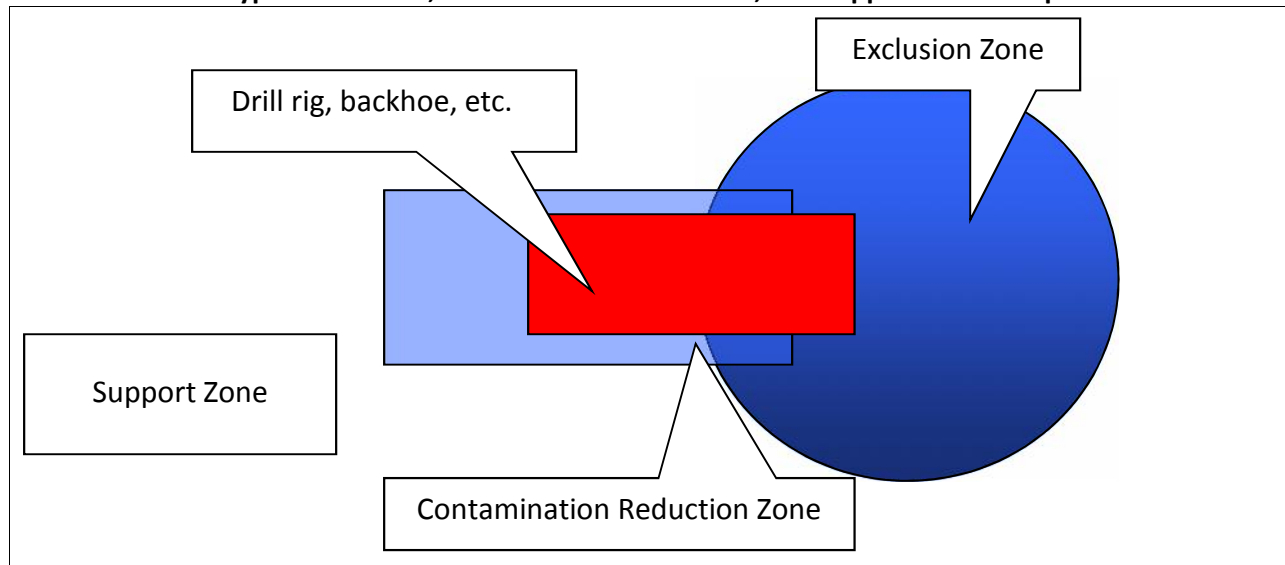

9.1.2 Communications

A loud and clear form of communication should be made available for Site personnel entering the work zones. Site communication may be in the form of hand signals, voice, or other communication devices. All forms of communication should be understood by all workers on the Site prior to starting work. Offsite communications may be conducted with mobile phones or walkie-talkies only if the atmosphere has been deemed non-explosive, and the person using the mobile device is in the SZ while placing the call, or inside the cab of a stationary vehicle.

9.1.3 Site Security

The Sparrows Point facility is not open to the public, and there is a strictly monitored main entrance with a security guard on duty at all times who only allows authorized personnel onto the Site. This limited access to the facility should eliminate the need for many requirements for specific site security except those needed to maintain work zone integrity, such as visible barriers around open excavations or EZs and CRZs. No site visitors will be allowed to travel unescorted by EAG or subcontractor personnel around the facility.

Once site visitors arrive at their intended work zone, they must check in with the Field Team Lead. If visitors are authorized to enter the CRZ and/or the EZ, they must have completed OSHA 1910.120 medical surveillance and training requirements (refer to Section 8.0 and Section 6.0). Visitors must wear

appropriate PPE before they will be allowed to enter the CRZ and/or the EZ. They must also be taken through this HASP during a brief tail-gate meeting and sign the Acknowledgement page in the back prior to engaging in any activities inside the CRZ or the EZ. All site visitors must follow the same site control measures and decontamination procedures as EAG personnel and subcontractors. The Project Manager must also be informed of each visitor's name, purpose for their visit, time of entry (and exit), location of tasks they wish to perform, whether they completed their intended task(s), and any other relevant information pertaining to their visit.

9.2 Decontamination Procedures

Decontamination of employees, subcontractors, and equipment leaving the EZ will be performed to minimize human exposure to hazardous substances and to minimize the spread of contamination to surrounding areas. The purpose of the CRZ is to provide a location to perform limited personnel decontamination and certain PPE and small equipment decontamination.

9.2.1 Personnel Decontamination

Persons leaving the EZ must pass through the CRZ and follow decontamination procedures before entering the SZ. Hand tools and other sampling equipment used in the EZ and reusable PPE (boots, safety glasses, etc.) will be appropriately cleaned prior to removal from the site each day. The step-by-step sequence for personnel decontamination is as follows:

- Remove boot covers (if used) at the boot washing station and place them in the disposal container provided
- Wash outer gloves and chemical resistant boots (if used) at the boot washing station
- Remove wrist tape (if used) and outer gloves and place them in the disposal container provided
- Remove ankle tape (if used) and disposable coveralls (if used) and place them in the disposal container provided
- Remove respirators (if used) and place each in designated locations in the CRZ
- Remove inner gloves and discard in the disposal container provided
- Wash hands and face and proceed to the SZ

Respirators must be fully decontaminated after each use by the personnel who previously wore them. All project employees and subcontractors are required to take a thorough soap and water shower in their home or motel room at the end of each workday. If monitoring or a general exposure assessment indicates that an employee has become contaminated, the employee or subcontractor will notify the EAG Project Manager and the Field Team Lead as soon as the contaminated state has been discovered.

9.2.2 Equipment Decontamination

All equipment leaving the EZ must be decontaminated either within the CRZ or at the central decontamination area. Small equipment, such as hand tools, will be thoroughly decontaminated within the CRZ before being placed in the SZ. The field tools may be scrubbed visually clean using a detergent solution (Alconox/Liquinox) with water and a stiff, long-bristled scrub brush. Following the solution scrubbing, the tools may be rinsed with distilled water or isopropyl alcohol. Any vehicle working in an EZ will be decontaminated before leaving the site. The vehicle will be cleaned by sweeping excess soil and debris off the wheels. A high-pressure sprayer will then be used to wash the wheels, if necessary.

Each piece of equipment will be inspected after cleaning for any soil remaining on the tires or elsewhere. All vehicles will be cleaned to the satisfaction of the Field Team Lead or a designated assistant prior to entering the SZ or leaving the site. Employees or subcontractors performing decontamination shall wear the appropriate level of PPE (refer to Section 5.0).

9.2.3 Waste Management

The Project Manager and the Field Team Leads will be responsible for overseeing the containerization and disposal of any field derived wastes. Contaminated or suspected contaminated field derived wastes shall be disposed of in accordance with all local, state, and/or federal regulations. Field derived wastes include decontamination rinse waters and other related decontamination generated wastes.

Soils and groundwater expected to be encountered during any sampling or intrusive work not to be contaminated, based on existing data, may be discharged to the ground surface in the immediate vicinity of the monitoring well. However, any known or suspected to be contaminated soil (in small quantities) or groundwater will be containerized for future removal, likely in 55-gallon drums or other approved storage vessels. Depending on the suspected contaminants, the recovered groundwater may be sent through one of the onsite groundwater treatment units. However, the treatment unit must be designed to address the contaminants of concern in the groundwater being treated. Otherwise, the liquid must be staged onsite for eventual offsite disposal at an approved facility.

Impacted soil, if in drums, will be staged in an area designated by the Project Manager or Field Team Lead for eventual disposal. For large excavations, where excavated soil is stockpiled, it may be necessary to place soils on plastic and cover with plastic to prevent any potential leachable runoff. The Project Manager and/or Field Team Lead will provide the proper guidance necessary for handling bulk soil piles.

Any NAPL recovered via remediation systems or manual recovery efforts will be properly containerized and either disposed of offsite as a recyclable material, if possible, or as a hazardous waste. The receiving facility must be an approved facility.

10.0 EMERGENCY RESPONSE AND CONTINGENCY PROCEDURES

The objective of emergency response and contingency procedures is to ensure that effective actions are implemented in a timely manner to minimize or control the effects of adverse events (e.g., potential chemical exposures, personal injuries, fires/explosions, and spills/releases). The following subsections describe the basic emergency responses required should an emergency take place during field investigation or remedial effort activities.

10.1 Emergency Phone Numbers

Emergency telephone numbers are listed in **Table 10-1**.

**Table 10-1
Emergency Telephone Numbers and Agencies**

Agency	Telephone Number
Security (Sparrows Point facility)	(410) 388-7761
Ambulance	911
Fire	911
Occupational Health Clinic	(410) 633-3600
Hospital	(410) 550-0100 (general) (410) 550-0350 (emergency)
National Response Center	(800) 424-8802
Poison Control Center - Maryland	(800) 222-1222
EAG Main Contact	
VP Remediation, Russ Becker	(314) 686-5611
Project Manager, James Calenda	(314) 620-3056

10.2 Injury/Illness Treatment

In the event of illness or injury, the following steps will be taken:

- Evaluate the extent of injuries or seriousness of illness.
- When employees require urgent medical attention, call for emergency assistance. First aid should be administered while awaiting an ambulance or paramedics. All emergency medical treatment, other than first aid, will be administered by the local paramedics. **Table 10-1** lists site emergency telephone numbers. In all cases, critical injuries must be immediately referred for professional medical attention.
- For a non-critical injury/illness, first aid will be administered by onsite personnel. Anyone sustaining a non-critical injury/illness who continues to work will be monitored by the Field Team Lead for any signs of worsening condition, if it is deemed that the person can return to work by the Team Lead and Project Manager. Injured personnel who later suffer any worsening change in status are to immediately notify the Team Lead or the Project Manager.

10.3 Occupational Health Clinic and Hospital Information

Occupational Health Clinic

The Concentra Medical Center, located at 1833 Portal Street, Baltimore, MD, is the closest occupational health clinic, just over 6 miles away. A map to the clinic is included as **Figure 10-1**. The clinic should be used for non-emergency injuries and illnesses.

Directions:

From Sparrow's Point Road, turn left onto Wharf Road;
Turn left onto MD-158 W/Bethlehem Blvd. (0.4 mile);
Turn right onto MD-157 N/Peninsula Expy. (2.7 miles);
Turn slight left onto Merritt Ave. (0.1 mile);
Merritt Ave. becomes Sollers Point Rd. (0.3 mile);
Turn left to stay on Sollers Point Rd (0.6 mile);
Turn left onto Williams Ave. (0.2 mile);
Turn right onto Dundalk Ave. (<0.1 miles);
Turn left onto Chandlery St. (0.1 mile);
Turn left onto Portal St.

Figure 10-1: Health Clinic (Non-Emergency) Map



Hospital

The Johns Hopkins Bayview Hospital is the closest emergency facility, just over 9 miles away. The hospital is located at 4940 Eastern Avenue in Baltimore, MD. **Figure 10-2** is a map to this hospital. Maps are also included in **Attachment E**.

Directions:

From the Sparrows Point Industrial Complex, go north on Route 151 for approximately one mile.

Take ramp (right) onto I-695 towards I-695/Essex.

At exit 40, take ramp (right) onto Route 151/North Point Boulevard North/MD 150;

Take ramp (right) onto Route 150 (Eastern Avenue).

Continue on Eastern Avenue to hospital on right.

Figure 10-2: Hospital Map

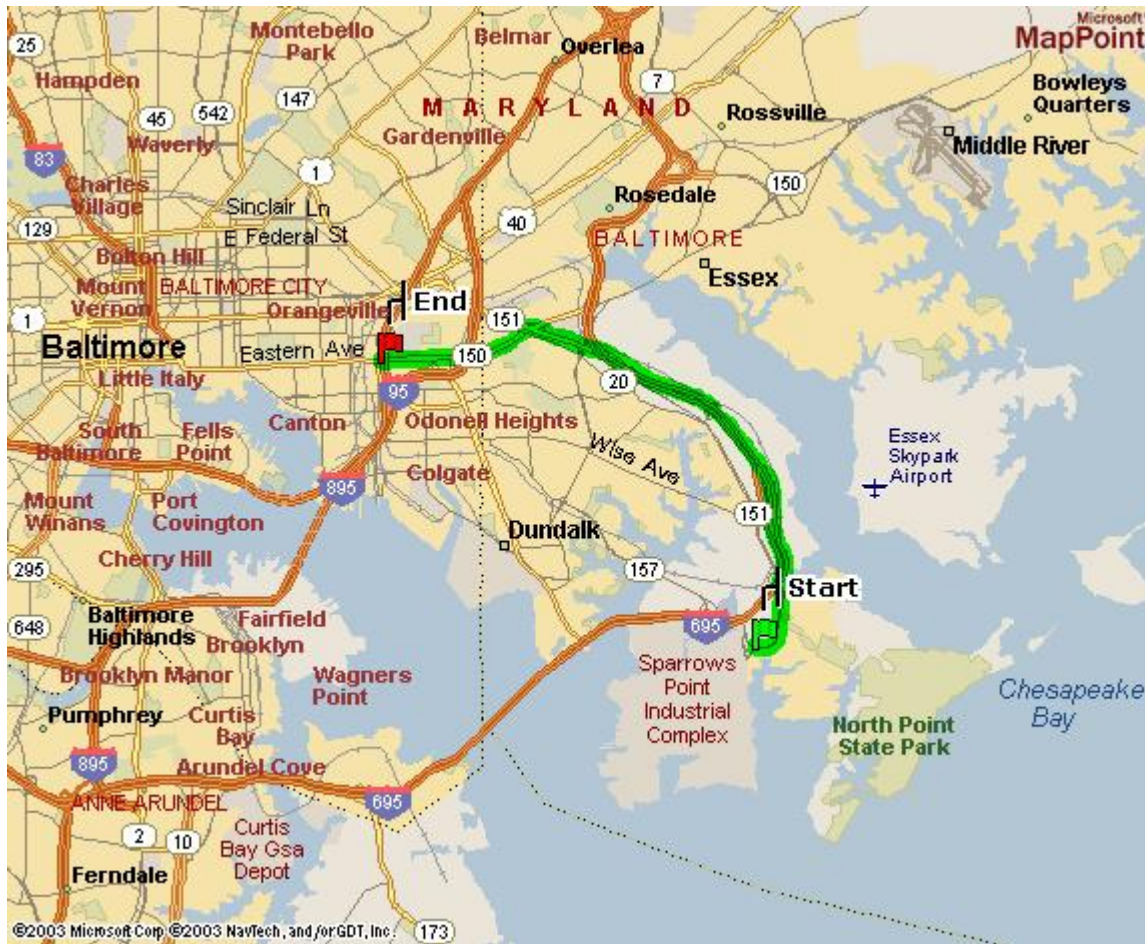

Prior to the start of field activities, the Project Field Team Leader will call to verify the telephone numbers and directions for the clinic and hospital, and then distribute location maps and the emergency telephone list to workers and vehicles.

10.4 Accident and Emergency Medical Response

All field team members will be aware of the location of a first aid kit kept onsite. All vehicles used to transport injured persons to an offsite medical facility will be provided with directions and a map to the medical facility.

If treatment beyond first aid is required, emergency response personnel will be contacted for assistance and transport. Before beginning site activities, the Project Field Team Leader will ensure that each field team member knows where the nearest emergency medical facilities are and how to get there. The closest hospital will be used in cases of life-threatening emergencies at the direction of the Project Field Team Leader. The telephone numbers of the local emergency services will be available in the SZ, and the Project Field Team Leader will brief the field team on the procedures for calling for help in an emergency.

Site personnel will inform the Project Manager of any medications, allergies, or other medical information that may be applicable for their medical treatment. The Project Manager will supply this information to emergency response personnel, and will accompany the victim to the hospital, if possible.

10.4.1 Chemical Exposure

In case of accidental overexposure to a hazardous material (groundwater, soil, and/or off-gas materials), guidelines shown in **Table 10-2** will be used.

Table 10-2
Chemical Exposure Guidelines

Type of Overexposure	First Aid Guidelines
Skin Contact	Skin: Wash/rinse the affected area thoroughly with copious amounts of soap and water.
	Eyes: Eyes should be rinsed for at least 15 minutes following chemical contamination.
	Contact emergency response personnel if required, or transport victim to the hospital.
Inhalation	Move the victim to fresh air.
	Contact emergency response personnel if required, or transport victim to the hospital.
Ingestion	Contact Poison Control Center.
	Contact emergency response personnel, or transport victim to the hospital.

10.4.2 Decontamination During a Medical Emergency

For minor medical problems or injuries, regular decontamination procedures will be followed. If emergency, life-saving first aid and/or medical treatment are required, regular decontamination procedures may need to be abbreviated or omitted:

- Do not attempt to wash or rinse an unresponsive victim unless the victim has been contaminated with an extremely toxic or corrosive chemical that may cause injury or loss of life to emergency response personnel.
- Outer garments can be removed if it does not cause a delay, interfere with treatment, or aggravate the problem.

- PPE can be cut away and respiratory protective equipment must always be removed.
- If contaminated clothing cannot be safely removed, then the victim should be wrapped in a blanket or plastic sheeting to prevent contamination to the inside of the ambulance and/or emergency response personnel.

The Project Manager or Field Team Lead will advise the medical staff as to the type of contamination possibly involved.

10.4.3 Small or Incipient Fire

A small fire is defined as a fire that can be extinguished with an available 20 pound type ABC fire extinguisher. An incipient fire is a fire that is small because it has just started. In the event of a small or incipient fire, the following minimum actions will be taken:

- Evacuate nearby personnel from the area, if possible, to an upwind location or to an area not affected by smoke or hazardous decomposition products if an upwind location is not feasible.
- Attempt to extinguish fire using portable fire extinguisher or by smothering.
- Contact emergency response personnel, as needed, for any injuries or exposures to hazardous decomposition products, or if fire cannot be put out.
- After the fire has been extinguished, or emergency response personnel have been contacted, notify the following project personnel:

The Project Manager

10.4.4 Large Fire or Explosion

An explosion, large fire or a small fire which cannot be extinguished is beyond the first line capabilities of EAG personnel. Professional emergency response personnel would be needed to provide emergency assistance for these types of incidents. In the event of a large fire, explosion or a small fire that cannot be extinguished, the following minimum actions will be taken:

- Evacuate all personnel from the site, if possible, to an upwind location, or to an area not affected by smoke or hazardous decomposition products if an upwind location is not feasible
- Perform a quick role call to account for all site personnel
- Contact the fire department
- Contact emergency response personnel, as needed, for any injuries or exposures to hazardous decomposition products
- After emergency response personnel have been contacted, notify the following project personnel:

The Project Manager

10.4.5 Adverse Weather Conditions

In the event of adverse weather conditions, the Project Manager will determine if work can continue without sacrificing the health and safety of site personnel. Threatening weather conditions will be monitored by the Project Manager and possibly the Team Lead via radio, television, internet, and/ or calls to the National Weather Service. Some of the conditions to be considered include:

- Potential for heat or cold stress
- Limited visibility

- Electrical storms
- Treacherous weather-related working conditions (i.e., heavy rainfall, icy conditions causing slippery footing hazards, etc.).

10.4.6 First Aid for Heat Stress/Cold Stress

First aid treatment for heat cramps includes shade, rest and fluid replacement. If available, the individual should drink electrolyte replacement fluids (e.g., Gatorade, Squincher or 10-K). The individual should recover within half an hour.

First aid treatment for heat exhaustion includes cooling the victim, elevating the feet and fluid replacement. If the individual has not recovered within half an hour, then transport the victim to the hospital for medical attention.

Heat stroke is a medical emergency, requiring the immediate cooling of the victim and transport to the hospital for medical treatment immediately.

First aid treatment for frost nip and frostbite includes covering the affected area with warmth and retreating to a warm area. If the individual has not recovered within half an hour, then transport the victim to the hospital for medical attention.

Frozen tissue is a medical emergency and the victim must receive medical attention immediately. Contact emergency response personnel immediately or transport the victim to the hospital.

First aid treatment of mild hypothermia includes using heat to raise the individual's body temperature. Heat may be applied to the victim in the form of heat packs, hot water bottles and blankets. If the individual has not recovered within half an hour, then transport the victim to the hospital for medical attention.

Severe hypothermia is a medical emergency and the victim must be transported to the hospital immediately. First aid treatment for severe hypothermia includes handling the victim very gently; rough handling may set off of an irregular heartbeat. **DO NOT** attempt to re-warm the severely hypothermic victim; re-warming may cause the development of an irregular heartbeat.

10.4.7 Snake Bites

If bitten, lower the extremity below the heart to reduce the poison's dissemination through the body. Remain calm, try to keep the heart rate reduced and seek medical attention immediately. Do not cut the wound or attempt to suck out the venom. Note any physical features (e.g., shape of head and color or pattern on body) of the snake.

10.4.8 Animal Bites

All bites should be treated as contaminated soft tissue injuries. Bites should be washed immediately with large amounts of soap and water. If soap is not available, flush the wound with water. The severity and onset of any infection is dependent upon the number of organisms (viruses or bacteria) introduced into the wound. Washing saliva out of the wound immediately will reduce the number of bacteria or viruses that can enter the tissue. Medical attention must be sought if rabies is suspected or the individual has not had a recent tetanus booster.

10.4.9 Insect Bites and Stings

Emergency care for insect bites and stings depends on the individual's reaction. To treat a sting that results in a minor reaction, remove the stinger by gently scraping it off the skin. Do not try to grasp the sac or stinger, because this forces the remaining venom into the skin. Once the stinger has been removed, clean the wound and surrounding area. Apply cold packs to slow the absorption of the venom and reduce pain and swelling. The treatment for a severe reaction to insect stings includes the following:

- Confirm with the victim whether they are highly allergic to the insect that stung them
 - If victim has gone into anaphylactic shock, retrieve their epi pen or other auto-injector and administer per the directions as hastily as possible
- Assuming the victim remains conscious, ask them to refrain from moving around, and to lie down
- Immobilize the injured area immediately
- If an extremity is involved, remove any rings or watch
- Keep the affected part low, below the level of the heart
- Apply cold compresses to the affected area
- If possible, try to identify the type of insect that inflicted the sting
- Transport the victim to a medical facility immediately, continuing supportive measures en route.

All employees and subcontractors must report severe reactions to insect stings prior to the beginning of work to both the Project Manager and Field Team Lead.

10.4.10 Poisonous Plants

Decontamination: Wash the skin immediately after contact with the plant. Proper washing may not be practical in the middle of the woods, but a product such as Technu or a small wash-up kit with prepackaged, alcohol-based cleansing tissues can be effective. Employees and subcontractors should not forget to wash contaminated clothing and clean up contaminated equipment prior to re-use.

Treatment: Options are as follows:

- Home treatment: Calamine lotion and an oatmeal bath (one cup to a tub full of water) can help relieve itching. To prevent secondary skin infection, scratching is not helpful and the fingernails should be cut to avoid damage to the skin. Over-the-counter hydrocortisone cream can decrease inflammation and itching; however, the label should be read and the cream used according to directions.
- When to see the doctor: Severe cases may require further treatment. A physician should be seen if the rash appears infected, is on the face or other sensitive body areas, or is too extensive to be easily treated at home.

10.4.11 Ticks

To remove an attached tick:

- Use fine-tipped tweezers or a "tick tool" to grasp the tick at the surface of the skin
- If tweezers are not available, use a tissue to protect the fingers (exposure to the tick's body fluid may lead to transmission of disease)
- With a steady motion, pull the tick straight out

Disinfect the bite site and the tweezers. Wash your hands thoroughly with soap and water. Save the tick if you can by placing it in a Ziploc bag in the freezer; this may help with diagnosis in the future.

If flu-like symptoms such as fatigue, headache, neck-stiffness or jaw discomfort begin following a tick bite, seek medical attention.

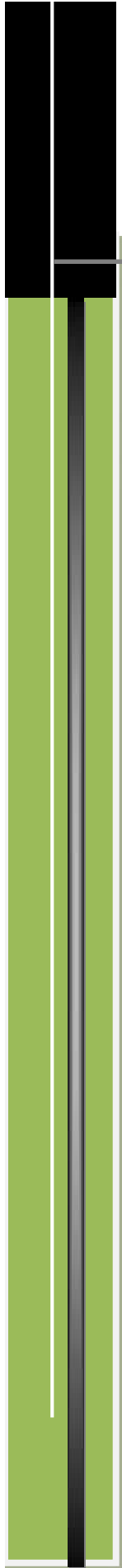

APPENDICES



Environmental Engineers

ATTACHMENT A
COMPLIANCE AGREEMENT

EAG HEALTH AND SAFETY PLAN

ACKNOWLEDGEMENT FORM

I, _____, have read (or had read to me), EAG's health and safety plan.
(Print Name)

I understand my responsibilities as they are defined in this plan and will abide by these rules and procedures, as well as any regulations or otherwise governing safety. When in doubt concerning safe job performance, I will speak to my immediate supervisor and/or Project Manager.

I understand EAG reserves the right to change or amend the HASP at any time.

I understand any violation to the plan policies or procedures will be cause for disciplinary action up to and including termination.

Employee Signature

Date

EAG Supervisor/Project Manager Signature

Date

ATTACHMENT B

Material Safety Data Sheets (MSDSs)