



ARM Group Inc.

Earth Resource Engineers and Consultants

May 11, 2018

Ms. Barbara Brown
Project Coordinator
Maryland Department of the Environment
1800 Washington Boulevard
Baltimore, MD 21230

Re: Response and Development Work Plan
Area B: Sub-Parcel B2-1 (Revision 1)
Update and Transmittal Letter
Tradepoint Atlantic
Sparrows Point, MD 21219

Dear Ms. Brown:

On behalf of EnviroAnalytics Group, LLC (EAG), ARM Group Inc. (ARM) is pleased to provide the following revised components of the Response and Development Work Plan for Sub-Parcel B2-1 (the Site) of the Tradepoint Atlantic property to the Maryland Department of the Environment (MDE) and United States Environmental Protection Agency (USEPA). The agencies provided a set of comments on the previous submission of the RADWP (Revision 0) via email on April 3, 2018, and a comment response letter was submitted to the agencies on April 19, 2018. Among the agency comments was a request for EAG to complete supplemental soil borings to provide additional samples and adequate spatial coverage for the evaluation of the proposed development of the Site.

Eight additional soil borings were completed in late-April 2018 to collect the requested samples. The soil boring logs from the eight additional locations are provided as **Attachment 1** to this letter, and the analytical results have been incorporated into the Screening Level Risk Assessment (SLRA) provided in the RADWP. The completion of the eight additional locations yielded a dataset with a total of 10 soil borings (including borings B2-005-SB and B2-006-SB which were retained from the prior submission); thus, the SLRA was completed using exposure point concentrations (EPCs) generated using ProUCL, rather than maximum values.

Hard copy replacement pages are provided for incorporation into the Sub-Parcel B2-1 RADWP (Revision 1) based on the responses presented in the April 2018 comment response letter and the results of the supplemental sampling. The enclosed CD provides a compiled PDF of the entire report with the inserted replacement pages and the updated electronic attachments. Revised cover and spine cardstock sheets are also provided for insertion into the binders. The attachments included with this letter for incorporation into Revision 1 include:

1. **Attachment 2** (revised text) – The report text was updated to be consistent with the revised SLRA, and to appropriately reference the supplemental sampling conducted in late-April 2018. Most of the changes were restricted to Sections 3.2 and 3.3 and were related to the completion of the eight supplemental soil borings described in the introduction of this letter. Appropriate updates related to the revised SLRA were made throughout the RADWP. Other changes in the text included the following:
 - a. Additional detail was added in Section 2.1 to address the demolition of the former Slab Hauler Repair Shop and the completed removal of petroleum-contaminated surficial soil (as provided in the response to Comment #1 in the April 2018 letter).
 - b. A new “Response Phase” was added within Section 4.0 to discuss the abandonment of shallow groundwater monitoring well SW-058-MWS, which is located inside the development boundary. The abandonment of this well was also added as a new line item in Section 7.0.
 - c. Section 5.1.1 was modified as outlined in the response to Comment #10 below.
2. **Figure 1** – Recent changes to some of the property-wide parcel boundaries in support of other Tradepoint Atlantic projects necessitated that this figure be updated. The boundary of Sub-Parcel B2-1 (or Parcel B2) was not modified.
3. **Figure 3** – This figure showing the removal of surficial soil was added as an additional RADWP attachment. It was previously sent to the agencies as an attachment to the April 2018 letter. A reference to **Figure 3** is provided in Section 2.1 of the RADWP.
4. **Figure 4** and **Figure 5** (previously included as **Figure 3** and **Figure 4**) – These figures were revised to show the 10 final soil boring locations and PAL exceedances within the proposed development area. The figures were also renumbered due to the inclusion of the new **Figure 3**.
5. **Figure 6** (previously included as **Figure 5**) – This figure was renumbered due to the inclusion of the new **Figure 3**.
6. **Table 1** and **Table 2** – The soil detection summary tables were regenerated to include the analytical data from the 10 final soil boring locations within the proposed development area. The seven additional soil borings that were originally included in Revision 0 of the RADWP that are outside of the development area (B1-135-SB, B2-001-SB, B2-002-SB, B2-041-SB, B2-042-SB, B2-048-SB, and B2-051-SB) were removed.
7. **Table 4** through **Table 12** – The SLRA tables were revised to include the analytical data from the 10 final soil boring locations. The revised SLRA was completed using the conventional ProUCL method.



8. **Appendix B** – The Excavation Division of Labor schedule was updated to display the maximum allowable exposure duration associated with the revised SLRA (45 days). None of the individual construction durations for specific crews/tasks were revised.
9. **Appendix C** – The calculation spreadsheet for the Construction Worker Soil Screening Levels (SSLs) was updated to display the maximum allowable exposure duration associated with the revised SLRA (45 days).
10. **Appendix F** (and Section 5.1.1) – The general utility cross section and associated RADWP text were revised to remove the specification that utility trenches are to be over-excavated to a minimum of 1-foot on all sides of the proposed utility. Although this requirement is proposed to be removed for general utility work, the specification for over-excavation has been retained in the Utility Excavation NAPL Contingency Plan and associated cross section provided in **Appendix G**. Section 5.1.1 was also updated to clarify that not all workers may be present at the pre-excavation meeting, but that the construction manager and Environmental Professional (EP) providing oversight of the project will attend. The construction manager will be responsible for conveying all relevant information regarding excavation/grading and/or utility work to the site workers who will be involved with these activities.
11. **Electronic Attachments CD** – The electronic attachments were updated to present the analytical data and SLRA findings from the 10 final soil boring locations within the proposed development area. Since the SLRA was revised to include the EPCs generated using ProUCL, the ProUCL input/output tables were included as new attachments. Based on the revised set of analytical data, the laboratory Certificates of Analysis (including Chains of Custody) and Data Validation Reports (DVRs) have been updated and replaced as needed. The lead evaluation spreadsheet was also revised.

If you have any questions, or if we can provide any additional information at this time, please do not hesitate to contact ARM Group Inc. at 410-290-7775.

Respectfully submitted,
ARM Group Inc.



Taylor R. Smith
Project Engineer



T. Neil Peters, P.E.
Senior Vice President



Attachment 1



ARM Group Inc.
Earth Resource Engineers
and Consultants

Client : EnviroAnalytics Group
 ARM Project No. : 150300M-6-3
 Project Description : Sparrows Point - Parcel B2
 Site Location : Sparrows Point, MD
 ARM Representative : M. Kedenburg, G.I.T.
 Checked by : M. Replogle, E.I.T.
 Drilling Company : ENRC
 Driller : J. Allen
 Drilling Equipment : Komatsu PC360LC

Date : 4/25/18
 Weather : 50s, cloudy
 Northing (US ft) : 567,936.59
 Easting (US ft) : 1,459,428.53

Boring ID: B2-062-SB

(page 1 of 1)

Depth (ft.)	% Recovery	PID Reading (PPM)	Sample ID/Interval	DESCRIPTION	USCS	REMARKS
0		1.5	B2-062-SB-1	(0-4') SLAG GRAVEL with SAND, loose, moist, dark brown to gray, no plasticity, no cohesion	GW	
		0.7				
		0.2				
		1.7	B2-062-SB-4			
5	End of boring					

Total Borehole Depth: 4' bgs.
 Boring terminated at 4' bgs due to refusal
 Boring completed with Komatsu excavator due to multiple geoprobe refusals



Client : EnviroAnalytics Group
 ARM Project No. : 150300M-6-3
 Project Description : Sparrows Point - Parcel B2
 Site Location : Sparrows Point, MD
 ARM Representative : M. Kedenburg, G.I.T.
 Checked by : M. Replogle, E.I.T.
 Drilling Company : Allied Drilling
 Driller : R. Sites
 Drilling Equipment : Geoprobe 7822DT

Date : 4/24/18
 Weather : 60s, cloudy
 Northing (US ft) : 568190.56
 Easting (US ft) : 1459741.15

Boring ID: B2-063-SB

(page 1 of 1)

Depth (ft.)	% Recovery	PID Reading (PPM)	Sample ID/Interval	DESCRIPTION	USCS	REMARKS
0		0.0	B2-063-SB-1	(0-2') SAND, medium, with GRAVEL, loose, dark brown, slightly moist, no plascitiy, no cohesion	SW/GW	Wet at 5' bgs Wood fragments
		0.0				
80		0.0		(2-3.5') GRAVEL, coarse, with SAND and CLAY, dense, red to dark brown, no plasticity, no cohesion	GW	
		0.0		(3.5-5') GRAVEL, coarse, loose, gray to pale yellow, moist, no plasticity, no cohesion	GP	
5		-	B2-063-SB-5			
		1.9		(5-6.5') SLAG GRAVEL, coarse, with SAND, dense to loose, dark brown, wet, no plasticity, no cohesion	GW	
		0.0		(6.5-7.5') CLAY with GRAVEL, firm, dark red to dark brown, wet, low plasticity, low cohesion	CL	
80		0.0		(7.5-9') CLAY with SAND, firm, dark bluish gray, wet, medium plasticity, medium cohesion	CL	
		0.0		(9-10') SLAG GRAVEL, coarse, with SAND, loose, pale yellow to bluish gray, wet, no plasticity, no cohesion	GW	
10		0.0				
				End of Boring		
15						

Total Borehole Depth: 10' bgs.
 Boring terminated at 10' bgs due to water



Client : EnviroAnalytics Group
 ARM Project No. : 150300M-6-3
 Project Description : Sparrows Point - Parcel B2
 Site Location : Sparrows Point, MD
 ARM Representative : M. Kedenburg, G.I.T.
 Checked by : M. Replogle, E.I.T.
 Drilling Company : ENRC
 Driller : J. Allen
 Drilling Equipment : Komatsu PC360LC

Date : 4/25/18
 Weather : 50s, cloudy
 Northing (US ft) : 567801.77
 Easting (US ft) : 1459680.11

Boring ID: B2-064-SB

(page 1 of 1)

Depth (ft.)	% Recovery	PID Reading (PPM)	Sample ID/Interval	DESCRIPTION	USCS	REMARKS
0			B2-064-SB-1	(0-3') GRAVEL with SAND and CLAY, loose, pale yellowish brown, slightly moist, no plascitty, no cohesion	GW	Metal fragments present Wet at 6' bgs
		1.0				
		0.7				
		1.0				
		1.0		(3-4') GRAVEL with SAND, loose, dark brown, moist, no plasticity, no cohesion	GW	
		1.0	B2-064-SB-5	(4-5') SLAG GRAVEL with SAND, loose, dark brown to black, moist, no plasticity, no cohesion	GP	
5				(5-6') SLAG GRAVEL with SAND, loose, dark brown to bluish black, wet, no plasticity, no cohesion	GW	
		1.2				
End of Boring						
10						

Total Borehole Depth: 6' bgs.
 Boring terminated at 6' bgs due to water
 Boring completed with Komatsu excavator due to multiple geoprobe refusals



Client : EnviroAnalytics Group
 ARM Project No. : 150300M-6-3
 Project Description : Sparrows Point - Parcel B2
 Site Location : Sparrows Point, MD
 ARM Representative : M. Kedenburg, G.I.T.
 Checked by : M. Replogle, E.I.T.
 Drilling Company : Allied Drilling
 Driller : Ryan Sites
 Drilling Equipment : Geoprobe 7822DT

Date : 4/23/18
 Weather : 50s, Sunny
 Northing (US ft) : 568027.07
 Easting (US ft) : 1459892.28

Boring ID: B2-065-SB

(page 1 of 1)

Depth (ft.)	% Recovery	PID Reading (PPM)	Sample ID/Interval	DESCRIPTION	USCS	REMARKS
0		-	B2-065-SB-1	(0-1') SAND, fine, loose, reddish brown, slightly moist, no plasticity, no cohesion	SW	Wet at 4.5' bgs
83	0.3			(1-4') SLAG GRAVEL, grayish blue, dry, no plasticity, no cohesion	GP	
	0.0					
55	0.0		B2-065-SB-4.5	(4-5.5') SAND with GRAVEL, loose, reddish brown to black, moist, no plasticity, no cohesion	SW/GP	
5	-					
	0.0			(5.5-9.2') GRAVEL with SAND, loose, reddish gray, wet, no plasticity, no cohesion	SW/GP	
76	0.0					
	0.0					
	0.0			(9.2-10') SAND, medium, very firm, brownish yellow to gray, no plasticity, no cohesion	SP	
10				End of Boring		
15						

Total Borehole Depth: 10' bgs.
 Boring terminated at 10' bgs due to water



ARM Group Inc.
Earth Resource Engineers
and Consultants

Client : EnviroAnalytics Group
 ARM Project No. : 150300M-6-3
 Project Description : Sparrows Point - Parcel B2
 Site Location : Sparrows Point, MD
 ARM Representative : M. Kedenburg, G.I.T.
 Checked by : M. Replogle, E.I.T.
 Drilling Company : ENRC
 Driller : J. Allen
 Drilling Equipment : Komatsu PC360LC

Date : 4/25/18
 Weather : 50s, Cloudy
 Northing (US ft) : 568112.51
 Easting (US ft) : 1459697.63

Boring ID: B2-066-SB

(page 1 of 1)

Depth (ft.)	% Recovery	PID Reading (PPM)	Sample ID/Interval	DESCRIPTION	USCS	REMARKS
0				(0-2') GRAVEL with SAND, loose, bluish gray, slightly moist, no plasticity, no cohesion		
	0.1		B2-066-SB-1		GW	
	0.8					
	0.3			(2-3') GRAVEL with SAND, loose, dark, brown to black, moist, no plasticity, no cohesion	GW	
	-			(3-5') GRAVEL with SAND, loose, dark brown to black, moist, to wet at 5ft bgs, no plasticity, no cohesion	GW	
	0.8		B2-066-SB-5			Wet at 5' bgs
5				End of boring		
10						

Total Borehole Depth: 5 bgs.
 Boring terminated at 5' bgs due to water
 Boring completed with Komatsu excavator due to multiple geoprobe refusals



ARM Group Inc.
Earth Resource Engineers
and Consultants

Client : EnviroAnalytics Group
 ARM Project No. : 150300M-6-3
 Project Description : Sparrows Point - Parcel B2
 Site Location : Sparrows Point, MD
 ARM Representative : M. Kedenburg, G.I.T.
 Checked by : M. Replogle, E.I.T.
 Drilling Company : Allied Drilling
 Driller : Ryan Sites
 Drilling Equipment : Geoprobe 7822DT

Date : 4/24/18
 Weather : 50s, Cloudy
 Northing (US ft) : 568143.09
 Easting (US ft) : 1459511.12

Boring ID: B2-067-SB

(page 1 of 1)

Depth (ft.)	% Recovery	PID Reading (PPM)	Sample ID/Interval	DESCRIPTION	USCS	REMARKS
0		-	B2-065-SB-1	(0-6') SAND with GRAVEL and SILT grading to GRAVEL with SAND, loose, dark brown to dark gray, no plasticity, no cohesion	SW/GW	
	64	1.7				
		3.0				
		3.2				
5		0.8	B2-065-SB-5			
		-		(6-7') CLAY with GRAVEL, firm, bluish gray to yellowish red, moist, no plasticity, no cohesion	CL	Some metal fragments present
	80	-		(7-10') SAND with CLAY and GRAVEL grading to fine SAND with CLAY, light brown to gray, dense, very moist, no plasticity, no cohesion, wet at 8 ft bgs	SP/SC	Wet at 8' bgs
		0.2				
		0.3				
10	End of Boring					

Total Borehole Depth: 10' bgs.
 Boring terminated at 10' bgs due to water



Client : EnviroAnalytics Group
 ARM Project No. : 150300M-6-3
 Project Description : Sparrows Point - Parcel B2
 Site Location : Sparrows Point, MD
 ARM Representative : M. Kedenburg, G.I.T.
 Checked by : M. Replogle, E.I.T.
 Drilling Company : Allied Drilling
 Driller : Ryan Sites
 Drilling Equipment : Geoprobe 7822DT

Date : 4/24/18
 Weather : 50s, Cloudy
 Northing (US ft) : 568,143.09
 Easting (US ft) : 1,459,511.12

Boring ID: B2-068-SB

(page 1 of 1)

Depth (ft.)	% Recovery	PID Reading (PPM)	Sample ID/Interval	DESCRIPTION	USCS	REMARKS
0		-	B2-068-SB-1	(0-5') SAND with GRAVEL, dense, dark brown, slightly moist, no plasticity, no cohesion	SW	Trace brick fragments
	78	0.4				
		0.4				
		1.4				
5		2.1	B2-065-SB-5	(5-7.5') SAND with CLAY and GRAVEL, dense, dark brown, very moist, no plasticity, no cohesion	SP/SC	Trace glass and metal fragments
	96	3.4				
		2.5				
		1.5		(7.5-8') GRAVEL with SILT, dense, black and reddish yellow, wet, no plasticity, no cohesion	GP	Wet at 7.5' bgs
		0.4		(8-10') CLAY with GRAVEL, firm to soft, bluish gray, wet, medium plasticity, medium cohesion	CL	
		0.0				
10	End of Boring					
15						

Total Borehole Depth: 10' bgs.
 Boring terminated at 10' bgs due to water



ARM Group Inc.
Earth Resource Engineers
and Consultants

Client : EnviroAnalytics Group
 ARM Project No. : 150300M-6-3
 Project Description : Sparrows Point - Parcel B2
 Site Location : Sparrows Point, MD
 ARM Representative : M. Kedenburg, G.I.T
 Checked by : M. Replogle, E.I.T.
 Drilling Company : ENRC
 Driller : J. Allen
 Drilling Equipment : Komatsu PC360LC

Date : 4/25/18
 Weather : 50s, cloudy
 Northing (US ft) : 567,961.38
 Easting (US ft) : 1,459,661.14

Boring ID: B2-069-SB

(page 1 of 1)

Depth (ft.)	% Recovery	PID Reading (PPM)	Sample ID/Interval	DESCRIPTION	USCS	REMARKS
0		1.7	B2-069-SB-1	(0-4') SAND with GRAVEL, dense, dark brown, slightly moist, no plasticity, no cohesion	GW	
		1.5				
		0.3				
		0.6	B2-069-SB-4			
		1.7		(4-5') SAND with CLAY and GRAVEL, loose, dark brown to black, wet, no plasticity, no cohesion	SP/SC	Wet at 5' bgs
5	End of boring					
10						

Total Borehole Depth: 5' bgs.
 Boring terminated at 5' bgs due to water.
 Boring completed with Komatsu excavator due to multiple geoprobe refusals

Attachment 2

RESPONSE AND DEVELOPMENT WORK PLAN

AREA B: SUB-PARCEL B2-1
TRADEPOINT ATLANTIC
SPARROWS POINT, MARYLAND

Prepared For:



ENVIROANALYTICS GROUP
1650 Des Peres Road, Suite 230
Saint Louis, Missouri 63131

Prepared By:



ARM GROUP INC.
9175 Guilford Road
Suite 310
Columbia, Maryland 21046

ARM Project No. 160443M-16

Respectfully Submitted,

A handwritten signature in black ink, appearing to read "Taylor R. Smith".

Taylor R. Smith
Project Engineer

A handwritten signature in black ink, appearing to read "Neil Peters".

T. Neil Peters, P.E.
Senior Vice President

Revision 1 – May 11, 2018

TABLE OF CONTENTS

1.0	Introduction.....	1
2.0	Site Description and History.....	3
2.1.	Site Description.....	3
2.2.	Site History.....	3
3.0	Environmental Site Assessment Results.....	5
3.1.	Phase I Environmental Site Assessment Results.....	5
3.2.	Phase II Investigation Results–Sub-Parcel B2-1.....	5
3.3.	Human Health Screening Level Risk Assessment (SLRA).....	9
3.3.1.	Analysis Process.....	9
3.3.2.	Sub-Parcel B2-1 SLRA Results and Risk Characterization.....	12
3.3.3.	Evaluation of Comprehensive Environmental Response, Compensation, and Liability (CERCLA) Criteria.....	15
4.0	Proposed Site Development Plan.....	18
5.0	Development Implementation Protocols.....	21
5.1.	Development Phase.....	21
5.1.1.	Soil Excavation and Utility Trenching.....	21
5.1.2.	Soil Sampling and Disposal.....	23
5.1.3.	Fill.....	23
5.1.4.	Erosion/Sediment Control.....	24
5.1.5.	Dust Control.....	24
5.2.	Water Management.....	25
5.2.1.	Groundwater PAL Exceedances.....	26
5.2.2.	Dewatering.....	26
5.3.	Health and Safety.....	27
5.4.	Institutional Controls (Future Land Use Controls).....	27
5.5.	Post Remediation Requirements.....	28
5.6.	Construction Oversight.....	28
6.0	Permits, Notifications and Contingencies.....	29
7.0	Implementation Schedule.....	30

TABLE OF CONTENTS (CONT.)

FIGURES

Figure 1	Area A & B Parcels.....	Following Text
Figure 2	Sub-Parcel B2-1 Development Area.....	Following Text
Figure 3	Slab Hauler Repair Shop – Surficial Soil Removal.....	Following Text
Figure 4	Soil Boring Final Field Sample Locations	Following Text
Figure 5	Soil Inorganic Exceedances	Following Text
Figure 6	Groundwater Sample Locations & PAL Exceedances	Following Text

TABLES

Table 1	Organic Compounds Detected in Soil.....	Following Text
Table 2	Inorganics Detected in Soil.....	Following Text
Table 3	Organics and Inorganics Detected in Groundwater	Following Text
Table 4	COPC Screening Analysis	Following Text
Table 5	Assessment of Lead	Following Text
Table 6	Soil Exposure Point Concentrations	Following Text
Table 7	Risk Ratios – Composite Worker Surface Soil.....	Following Text
Table 8	Risk Ratios – Composite Worker Sub-Surface Soil	Following Text
Table 9	Risk Ratios – Composite Worker Pooled Soil.....	Following Text
Table 10	Risk Ratios – Construction Worker Surface Soil	Following Text
Table 11	Risk Ratios – Construction Worker Sub-Surface Soil.....	Following Text
Table 12	Risk Ratios – Construction Worker Pooled Soil.....	Following Text

APPENDICES

Appendix A	Request Letter from Tradepoint Atlantic.....	Following Text
Appendix B	Intrusive Work – Division of Labor.....	Following Text
Appendix C	Construction Worker SSLs – Calculation Spreadsheet	Following Text
Appendix D	Development Plan Drawings	Following Text
Appendix E	Health and Safety Plan.....	Following Text
Appendix F	Utility Trench Section Detail.....	Following Text
Appendix G	Utility Excavation NAPL Contingency Plan	Following Text

TABLE OF CONTENTS (CONT.)

ELECTRONIC ATTACHMENTS

Soil Laboratory Certificates of Analysis.....	Electronic Attachment
Soil Data Validation Reports	Electronic Attachment
Groundwater Laboratory Certificates of Analysis	Electronic Attachment
Groundwater Data Validation Reports.....	Electronic Attachment
ProUCL Input Tables (formatted soil analytical data).....	Electronic Attachment
ProUCL Output Tables	Electronic Attachment
Lead Evaluation Spreadsheet.....	Electronic Attachment

1.0 INTRODUCTION

ARM Group Inc. (ARM), on behalf of EnviroAnalytics Group (EAG), has prepared this Response and Development Work Plan (RADWP) for a portion of the Tradepoint Atlantic property that has been designated as Area B: Sub-Parcel B2-1 (the Site). Tradepoint Atlantic submitted a letter (**Appendix A**) requesting an expedited remedial plan review to achieve construction deadlines for the proposed development on this Site. The full Parcel B2 comprises 122.7 acres of the approximately 3,100-acre former plant property located as shown on **Figure 1**. Sub-Parcel B2-1 consists of approximately 7.2 acres to be developed in the northwestern portion of Parcel B2.

The conduct of any environmental assessment and cleanup activities on the Tradepoint Atlantic property, as well as any associated development, is subject to the requirements outlined in the following agreements:

- Administrative Consent Order (ACO) between Tradepoint Atlantic (formerly Sparrows Point Terminal, LLC) and the Maryland Department of the Environment (MDE), effective September 12, 2014; and
- Settlement Agreement and Covenant Not to Sue (SA) between Tradepoint Atlantic (formerly Sparrows Point Terminal, LLC) and the United States Environmental Protection Agency (USEPA), effective November 25, 2014.

Sub-Parcel B2-1 is part of the acreage that was removed (Carveout Area) from inclusion in the Multimedia Consent Decree between Bethlehem Steel Corporation, the USEPA, and the MDE (effective October 8, 1997) as documented in correspondence received from USEPA on September 12, 2014. Based on this agreement, USEPA determined that no further investigation or corrective measures will be required under the terms of the Consent Decree for the Carveout Area. However, the SA reflects that the property within the Carveout Area will remain subject to the USEPA's Resource Conservation and Recovery Act (RCRA) Corrective Action authorities.

An application to enter the full Tradepoint Atlantic property (3,100 acres) into the Maryland Department of the Environment Voluntary Cleanup Program (MDE-VCP) was submitted to the MDE and delivered on June 27, 2014. The property's current and anticipated future use is Tier 3 (Industrial), and plans for the property include demolition and redevelopment over the next several years.

In consultation with the MDE, Tradepoint Atlantic affirms that it desires to accelerate the assessment, remediation and redevelopment of certain sub-parcels within the larger site due to current market conditions. To that end, the MDE and Tradepoint Atlantic agree that the Controlled Hazardous Substance (CHS) Act (Section 7-222 of the Environment Article) and the CHS Response Plan (Code of Maryland Regulations (COMAR) 26.14.02) shall serve as the

governing statutory and regulatory authority for completing the development activities on the Sub-Parcel B2-1 and complement the statutory requirements of the Voluntary Cleanup Program (Section 7-501 of the Environment Article). Upon submission of a Site RADWP and completion of any remedial activities for the sub-parcel, the MDE shall issue a No Further Action Letter (NFA) upon a recordation of an environmental covenant describing any necessary land use controls for the specific sub-parcel. At such time that all the sub-parcels within the larger parcel have completed remedial activities, Tradepoint Atlantic shall submit to the MDE a request for issuing a Certificate of Completion (COC) as well as all pertinent information concerning completion of remedial activities conducted on the parcel. Once the VCP has completed its review of the submitted information it shall issue a COC for the entire parcel described in Tradepoint Atlantic's VCP application.

Alternatively, Tradepoint Atlantic or other entity may elect to submit an application for a specific sub-parcel and submit it to the VCP for review and acceptance. If the application is received after the cleanup and redevelopment activities described in this RADWP are implemented and a NFA is issued by the MDE pursuant to the CHS Act, the VCP shall prepare a No Further Requirements Determination for the sub-parcel.

If Tradepoint Atlantic or other entity has not carried out cleanup and redevelopment activities described in the RADWP, the cleanup and redevelopment activities may be conducted under the oversight authority of either the VCP or the CHS Act, so long as those activities comport with this RADWP.

The Sub-Parcel B2-1 Development Area (the Site) consists of approximately 7.2 acres currently slated for development and use as an electrical substation, including construction of minor support structures and an access road (**Figure 2**).

This RADWP provides a Site description and history; summary of environmental conditions identified by the Phase I Environmental Site Assessment (ESA); summary of environmental conditions identified by the Parcel B2 Phase II Investigation and supplemental sampling activities; a human health Screening Level Risk Assessment (SLRA) conducted for the identified conditions; and any necessary engineering and/or institutional controls to facilitate the planned development and address the impacts and potential human health exposures. These controls include work practices and applicable protocols that are submitted for approval to support the development and use of the Site. Engineering/institutional controls approved and installed for this RADWP shall be described in closure certification documentation submitted to the MDE demonstrating that exposure pathways on the Site are addressed in a manner that protects public health and the environment. The remaining acreage of Parcel B2 will be addressed in future work associated with completion of the obligations of the ACO and associated VCP requirements. This work will include assessments of risk and, if necessary, RADWPs to address risks associated with future land use.

2.0 SITE DESCRIPTION AND HISTORY

2.1. SITE DESCRIPTION

Parcel B2 includes an area of 122.7 acres as shown in **Figure 1**. The Sub-Parcel B2-1 Development Area consists of 7.2 acres in the northwestern portion of Parcel B2 which will include an electrical substation and supporting structures (**Figure 2**). The Site is currently zoned Manufacturing Heavy-Industrial Major (MH-IM), and is not occupied by a permanent tenant. MCM Management Corporation (MCM) is currently using this area on a temporary basis for vehicle maintenance and repair activities, as well as for staging of construction equipment.

One existing building at the Site (former Slab Hauler Repair Shop) will necessarily be demolished prior to development, and MCM will be responsible for the demolition of this structure. MCM has established procedures for conducting demolition activities with the MDE, including responses to possible additional releases during demolition. The demolition of the Hauler Repair Shop will be coordinated with the MDE by Tradepoint Atlantic and MCM. The demolition contractor will conduct an environmental sweep of all structures prior to demolition. This sweep ensures that all tanks have been emptied, light bulbs/ballasts removed, and any equipment that contains hydraulic oil has been de-inventoried. Tradepoint Atlantic has indicated that the demolition of the structure is expected to be completed by June 1, 2018.

Petroleum-impacted surficial material was previously removed during a response action in the vicinity of the Slab Hauler Repair Shop under the guidance of the MDE. The approximate areas of surficial soil removal are indicated on **Figure 3**. With respect to removal of this material, the MDE provided their approval of the completed response actions on December 20, 2017. Therefore, no further work is proposed in this RADWP to address the historical impacts. The sub-parcel has been cleared of all significant vegetation. There is no groundwater use on-site or within the surrounding Tradepoint Atlantic property.

Sub-Parcel B2-1 is at an elevation of approximately 12 feet above mean sea level (amsl). Elevations in the parcel are fairly uniform between 9 and 14 feet over the majority of the sub-parcel area, with several small stockpiles at slightly increased elevations. According to Figure B-2 of the Stormwater Pollution Prevention Plan (SWPPP) Revision 5 dated June 1, 2017, stormwater from the Site is directed to the Tin Mill Canal (TMC), which flows to the Humphrey Creek Wastewater Treatment Plant (HCWWTP) for treatment, and is ultimately discharged to Bear Creek through National Pollution Discharge Elimination System (NPDES) Outfall 014.

2.2. SITE HISTORY

From the late 1800s until 2012, the production and manufacturing of steel was conducted at Sparrows Point. Iron and steel production operations and processes at Sparrows Point included raw material handling, coke production, sinter production, iron production, steel production, and

semi-finished and finished product preparation. In 1970, Sparrows Point was the largest steel facility in the United States, producing hot and cold rolled sheets, coated materials, pipes, plates, and rod and wire. The steel making operations at the Facility ceased in fall 2012.

The proposed Sub-Parcel B2-1 Development Area is currently occupied by the former Slab Hauler Repair Shop. A Railroad Office (now under the authority of Tradepoint Atlantic) is located immediately to the northwest of the sub-parcel. According to recent site visits by ARM personnel, both the former Slab Hauler Repair Shop and the Railroad Office remain intact and the area has been observed to be active and is currently used by MCM for vehicle maintenance and repair activities. The Site was also observed to be used as a staging area for MCM's construction and demolition equipment. According to historical site drawings, there were no significant steel making processes conducted within the boundary of Sub-Parcel B2-1. More information regarding historical activities can be found in the agency approved Phase II Investigation Work Plan for Parcel B2 (dated May 17, 2017).

3.0 ENVIRONMENTAL SITE ASSESSMENT RESULTS

3.1. PHASE I ENVIRONMENTAL SITE ASSESSMENT RESULTS

A Phase I ESA was completed by Weaver Boos Consultants for the entire Sparrows Point property on May 19, 2014. Weaver Boos completed site visits of Sparrows Point from February 19 through 21, 2014, for the purpose of characterizing current conditions at the former steel plant. The Phase I ESA identified particular features across the Tradepoint Atlantic property which presented potential risks to the environment. These Recognized Environmental Conditions (RECs) included buildings and process areas where releases of hazardous substances and/or petroleum products potentially may have occurred. The Phase I ESA also relied upon findings identified during a previous visual site inspection (VSI) conducted as part of the RCRA Facility Assessment (RFA) prepared by A.T. Kearney, Inc. dated August 1993, for the purpose of identifying Solid Waste Management Units (SWMUs) and Areas of Concern (AOCs) on the property. This 1991 VSI is regularly cited in the Description of Current Conditions (DCC) Report prepared by Rust Environment and Infrastructure, dated January 1998 (included with Weaver Boos' Phase I ESA). Weaver Boos' distinction of a REC or Non-REC was based upon the findings of the DCC Report (which was prepared when the features remained on-site in 1998) or on observations of the general area during their site visit. Weaver Boos made the determination to identify a feature as a REC based on historical information, observations during the site visit, and prior knowledge and experience with similar facilities.

The Phase I ESA and associated reports did not identify any RECs, SWMUs, or AOCs within a reasonable proximity to the Sub-Parcel B2-1 boundary.

3.2. PHASE II INVESTIGATION RESULTS—SUB-PARCEL B2-1

A Phase II Investigation specific to soil conditions was performed for the Site in accordance with the requirements outlined in the ACO as further described in the Phase II Investigation Work Plan – Area B: Parcel B2 (Revision 1) dated May 17, 2017. This Work Plan and an associated comment response letter dated June 14, 2017 were approved by the agencies on June 26, 2017. The agencies later made a determination that three additional soil borings proposed in the June 14, 2017 comment response letter in the vicinity of the Slab Hauler Repair Shop would not be required, as stated in correspondence received from the MDE on December 22, 2017. In addition, supplemental soil borings were completed at the Site to provide adequate spatial coverage in accordance with the Sub-Parcel B2-1 RADWP Comment Response Letter dated April 19, 2018. The completion of the supplemental locations yielded a dataset with a total of 10 soil borings to characterize current conditions within Sub-Parcel B2-1. All soil borings were collected and analyzed in accordance with agency-approved protocols. Findings from the Parcel B2 Phase II Investigation that are relevant to the Sub-Parcel B2-1 Development Area are summarized in this document, along with the results from the supplemental samples.

The Phase II Investigation of Parcel B2 was developed to target the specific features which represented a potential release of hazardous substances and/or petroleum products to the environment, including RECs, SWMUs, and AOCs as well as numerous other targets defined from former operations that would have the potential for environmental contamination. Samples were also collected at site-wide locations to ensure full coverage of the parcel. As discussed above, no RECs, SWMUs, or AOCs were identified in close proximity to Sub-Parcel B2-1. The Slab Hauler Repair Shop was targeted for sampling under the Parcel B2 Phase II Investigation. The supplemental boring locations were selected to provide representative spatial coverage of the development area, and to yield a sufficient number of samples to facilitate statistical analysis.

Based on the scope of development and limited footprint for the proposed substation (7.2 acres), five soil samples collected during the Parcel B2 Phase II Investigation (from the two boring locations indicated in **Figure 4**: B2-005-SB and B2-006-SB) were selected for a representative evaluation of Sub-Parcel B2-1. In addition, a total of 16 soil samples were collected under the Sub-Parcel B2-1 RADWP Comment Response Letter dated April 19, 2018 (from the eight supplemental locations shown on **Figure 4**: B2-062-SB, B2-063-SB, B2-064-SB, B2-065-SB, B2-066-SB, B2-067-SB, B2-068-SB, and B2-069-SB). All of the listed borings are located within the proposed development area such that the data from these borings should be considered representative of potential future exposures within Sub-Parcel B2-1. Please note that locations B2-062-SB, B2-064-SB, B2-066-SB, and B2-069-SB were completed using an excavator due to repeated equipment refusal while using the Geoprobe[®].

Soil boring B2-005-SB provided analytical soil data from two completion dates (June 1 and June 27, 2017). On the initial date, this soil boring could only be completed to a depth of 1-foot below ground surface (bgs) due to equipment refusal and restrictions due to ongoing utility mark-outs. Another supplemental boring was completed at a nearby location (approximately 25 feet to the southeast of the original location) in order to provide subsurface data once the utilities were marked. The initial shallow boring from June 1, 2017 has been assigned ID# B2-005A-SB, and the boring completed on June 27, 2017 has been assigned ID# B2-005-SB. The final location of boring B2-005-SB is indicated on **Figure 4**.

Soil samples were analyzed for the USEPA Target Compound List (TCL) semi-volatile organic compounds (SVOCs), total petroleum hydrocarbons (TPH) diesel range organics (DRO) and gasoline range organics (GRO), Oil & Grease, USEPA Target Analyte List (TAL) metals, hexavalent chromium, and cyanide based on the parcel-specific sampling plan for Parcel B2. Shallow soil samples (0 to 1 foot bgs) were also analyzed for polychlorinated biphenyls (PCBs). If a sample interval had exceeded a photoionization detector (PID) reading of 10 ppm, the respective sample interval would have been additionally analyzed for volatile organic compounds (VOCs); however, none of the samples relevant for this project exceeded the specified PID screening threshold. The laboratory Certificates of Analysis (including Chains of Custody) and relevant Data Validation Reports (50% validated soil data – determined based on

the complete dataset obtained from the Parcel B2 Phase II Investigation) are included as electronic attachments. The Data Validation Reports contain qualifier keys for the flags assigned to individual results in the attached summary tables.

Soil sample results relevant for the Sub-Parcel B2-1 Development Area were screened against the Project Action Limits (PALs) established in the property-wide Quality Assurance Project Plan (QAPP) dated April 5, 2016, or based on other direct agency guidance (e.g., TPH/Oil & Grease). **Table 1** and **Table 2** provide a summary of the detected organic compounds and inorganics in the soil samples submitted for laboratory analysis, and **Figure 5** presents a summary of the soil sample results that exceeded the PALs. The tables and figures include all locations and analytical data relevant for the proposed Sub-Parcel B2-1 Development Area. The PALs for relevant polynuclear aromatic hydrocarbons (PAHs) have been adjusted upward based on revised toxicity data published in the USEPA Regional Screening Level (RSL) Composite Worker Soil Table. PAL exceedances in the soil samples relevant for Sub-Parcel B2-1 were limited to three inorganics (arsenic, manganese, and hexavalent chromium). Arsenic was the most common PAL exceedance.

No samples evaluated in this RADWP exceeded the PAL for TPH/Oil & Grease (6,200 mg/kg). Potential evidence of non-aqueous phase liquid (NAPL) was observed in a soil core during the completion of one boring located outside of the boundary of development (B2-051-SB). During the completion of this boring, evidence of trace to light tar with a solvent odor was present in a narrow interval between 6 and 6.2 feet bgs. Due to these conditions, a NAPL screening piezometer (B2-051-PZ shown on **Figure 6**) was installed at this location with a screen interval from 3 to 13 feet bgs to assess the potential mobility of NAPL to groundwater. Piezometers installed for NAPL screening purposes are typically gauged at standard intervals (0-hour, 48-hour, and >30-day) using an oil-water interface probe. In this case, a 30-day gauging measurement could not be collected; the piezometer was located too close to an active roadway and had to be abandoned prior to the 30 day check. However, there was no evidence of NAPL during any of the completed gauging measurements, and a supplemental groundwater sample was collected at this location to provide additional analytical data (as discussed below). Contingency measures to address the potential presence of NAPL which could be encountered at the Site are addressed in subsequent sections of this RADWP.

Groundwater within Parcel B2 was investigated in accordance with the separate Area B Groundwater Investigation Work Plan (Revision 3) dated October 6, 2015. This separate Work Plan was pre-approved by the agencies on October 5, 2015. During the Area B Groundwater Investigation, three shallow permanent wells were installed and sampled within a reasonable proximity to Sub-Parcel B2-1. These locations (FM01-PZM003, SW08-PZM003, and SW-058-MWS) were installed to facilitate the collection of groundwater samples and to support the definition of the Area B potentiometric surface. In addition, a supplemental groundwater sample was obtained from the NAPL screening piezometer B2-051-PZ prior to its abandonment.

Location B2-051-PZ was not specified to be sampled in the Parcel B2 Work Plan, but samples were collected to provide additional analytical data at this location since a 30-day NAPL gauging measurement could not be completed. Groundwater is not anticipated to be encountered in the sub-parcel based on the proposed development plan described herein; therefore, groundwater conditions below the Site are not a significant concern.

The shallow groundwater samples collected from FM01-PZM003, SW08-PZM003, SW-058-MWS, and B2-051-PZ were analyzed for TLC-VOCs, TCL-SVOCs, TAL-Dissolved Metals, TPH-DRO, TPH-GRO, hexavalent chromium, and cyanide. The permanent groundwater wells sampled for the Area B Groundwater Investigation were additionally analyzed for TAL-Metals (total). The groundwater sample collected at B2-051-PZ was also analyzed for Oil & Grease. The agencies have specified the requirements for analysis of TPH/Oil & Grease throughout the investigation process. Samples obtained during the Area B Groundwater Investigation were not required to be analyzed for Oil & Grease based on the requirements specified at the time of implementation. The laboratory Certificates of Analysis (including Chains of Custody) and Data Validation Reports for the Area B Groundwater Investigation (100% validated groundwater data) and for sample B2-051-PZ (non-validated) are included as electronic attachments. The laboratory and data validation reports contain qualifier keys for the flags assigned to the individual results in the attached summary table.

The groundwater analytical results were screened against the PALs established in the property-wide QAPP dated April 5, 2016, or based on other direct agency guidance (e.g., TPH/Oil & Grease). **Table 3** presents a (combined) summary of the detected organic compounds and inorganics in the aqueous samples obtained from these shallow groundwater sample collection points. Similar to the evaluation of soil data, the PALs for relevant PAHs have been adjusted upward based on revised toxicity data published in the USEPA RSL Resident Tapwater Table. **Figure 6** presents a summary of the groundwater results at locations FM01-PZM003, SW08-PZM003, SW-058-MWS, and B2-051-PZ that exceeded the aqueous PALs. Groundwater PAL exceedances in the vicinity of Sub-Parcel B2-1 consisted of one VOC (chloroform), one SVOC (benz[a]anthracene), DRO, and one total/dissolved metal (vanadium). For simplicity, the inorganic PAL exceedances shown on the figure do not include duplicate exceedances of total and dissolved vanadium. If both total and dissolved concentrations exceeded the PAL (as was the case at location FM01-PZM003), the value for total vanadium is displayed on the figure.

While concentrations of these constituents did exceed the aqueous PALs specified in the QAPP, none of the detected levels were significantly elevated and there were no concerns related to vapor intrusion. Each groundwater collection point was also inspected for evidence of NAPL using an oil-water interface probe prior to sampling. None of the piezometers or permanent wells relevant for Sub-Parcel B2-1 showed evidence of NAPL during these checks. The complete findings of the Area B Groundwater Investigation (including the detailed vapor intrusion screening) were presented to the agencies in the Area B Groundwater Phase II

Investigation Report (Revision 0) dated September 30, 2016. If groundwater is encountered during development, any potential Construction Worker exposures will be managed by the implementation of health and safety protocols.

3.3. HUMAN HEALTH SCREENING LEVEL RISK ASSESSMENT (SLRA)

3.3.1. Analysis Process

A human health Screening Level Risk Assessment (SLRA) has been conducted for soils in Sub-Parcel B2-1 to further evaluate the Site conditions in support of the design of necessary response measures. The SLRA included the following evaluation process:

Identification of Exposure Units (EUs): The SLRA was conducted for the entire development area (7.2 acres) evaluated as a single EU. This evaluation included data from 10 locations (two Phase II Investigation borings and eight supplemental borings) completed within the proposed development area (**Figure 4**). The site-wide EU corresponds to the Limit of Disturbance (LOD) for the project.

Identification of Constituents of Potential Concern (COPCs): Compounds that are present at concentrations at or above the USEPA RSLs set at a target cancer risk of $1E-6$ or target non-cancer Hazard Quotient (HQ) of 0.1 were identified as COPCs to be included in the SLRA. A COPC screening analysis is provided in **Table 4** to identify compounds above the relevant screening levels.

Exposure Point Concentrations (EPCs): The COPC soil datasets for the site-wide EU were divided into surface (0 to 1 foot) and subsurface (>1 foot) depths for estimation of potential EPCs. An evaluation of pooled surface and subsurface soil data was also performed. Thus, there are three soil datasets for the site-wide EU. A statistical analysis was performed for each COPC dataset using the ProUCL software (version 5.0) developed by the USEPA to determine representative reasonable maximum exposure (RME) values for the EPC for each constituent. The RME value is typically the 95% Upper Confidence Limit (UCL) of the mean. For lead, the arithmetic mean for each depth was calculated for comparison to the Adult Lead Model (ALM)-based values, and any individual results exceeding 10,000 mg/kg would be delineated for possible excavation and removal (if applicable). For PCBs, all results equaling or exceeding 50 mg/kg would be delineated for excavation and removal (if applicable).

Risk Ratios: The surface soil EPCs, subsurface soil EPCs, and pooled soil EPCs were compared to the USEPA RSLs for the Composite Worker and to site-specific Soil Screening Levels (SSLs) for the Construction Worker based on equations derived in the USEPA Supplemental Guidance for Developing Soil Screening Levels for Superfund Sites (OSWER 9355.4-24, December 2002). The risk ratios were calculated with a

cancer risk of $1E-6$ and a non-cancer HQ of 1. Site-specific risk-based evaluations were completed for a range of potential exposure frequencies. For each exposure frequency, risk ratios for the carcinogens were summed to develop a screening level estimate of the cumulative cancer risk. The risk ratios for the non-carcinogens were segregated and summed by target organ to develop a screening level estimate of the cumulative non-cancer hazard. These calculated risk ratios were used to determine the exposure frequency that would result in risk ratios equivalent to a cumulative cancer risk of $1E-5$ or Hazard Index (HI) of 1 for any individual target organ. This analysis indicated that an exposure frequency of 45 days would be allowable in the site-wide EU before additional worker protections or more detailed job safety evaluations might be needed.

There is no potential for human exposure to groundwater for a Composite Worker since groundwater is not used on the Tradepoint Atlantic property (and is not proposed to be utilized). In the event that construction/excavation leads to a potential Construction Worker exposure to groundwater during development, health and safety plans and procedures shall be followed to limit exposure risk.

Assessment of Lead: For lead, the arithmetic mean concentrations for surface soils, subsurface soils, and pooled soils for the site-wide EU were compared to the applicable RSL (800 mg/kg) as an initial screening. If the mean concentrations for the EU were below the applicable RSL, the EU was identified as requiring no further action for lead. If a mean concentration exceeded the RSL, the mean values were compared to calculated ALM values (ALM Version dated 6/21/2009 updated with the 5/17/2017 OLEM Directive) with inputs of 1.8 for the geometric standard deviation and a blood baseline lead level of 0.6 ug/dL. The ALM calculation generates a soil lead concentration of 2,518 mg/kg, which is the most conservative (i.e., lowest) concentration which would yield a probability of 5% of a blood lead concentration of 10 ug/dL. If the arithmetic mean concentrations for the EU were below 2,518 mg/kg, the EU was identified as requiring no further action for lead. The lead averages and ALM screening levels are presented for surface, subsurface, and pooled soils in **Table 5**. For lead, any analytical results equaling or exceeding 10,000 mg/kg would be delineated for possible excavation and removal (if applicable).

Assessment of TPH-DRO/GRO and Oil & Grease: EPCs were not calculated for TPH-DRO/GRO or Oil & Grease. Instead, the individual results were compared to the PAL set to a HQ of 1 (6,200 mg/kg). No samples evaluated for the site-wide EU exceeded the PAL for TPH/Oil & Grease. One soil boring (B2-051-SB) exhibited evidence of potential NAPL contamination in its soil core (trace to light tar with a solvent odor located in a narrow interval from 6 to 6.2 feet bgs), but no utilities are proposed in the vicinity of this soil boring during development. Therefore, these contaminants are not considered to be of significant concern at the Site.

Risk Characterization Approach: For the site-wide EU, if the baseline risk ratio for each non-carcinogenic COPC or cumulative target organ does not exceed 1 (with the exception of lead), and the sum of the risk ratios for the carcinogenic COPCs does not exceed a cumulative cancer risk of $1E-5$, then a no further action determination will be recommended. The primary EPC comparisons to determine the need for possible remedial action will be the Construction Worker scenario comparisons to the surface and subsurface soil EPCs, as well as the Composite Worker comparison to the surface soil EPCs. However, no further action will only be approvable if subsurface soil EPCs are compared to the Composite Worker RSLs in addition to the Construction Worker SSLs, and the cancer and non-cancer risk estimates are less than or equal to $1E-5$ and 1, respectively. Pooled soil data has also been evaluated and included for discussion.

If the baseline estimate of cumulative cancer risk exceeds $1E-5$ but is less than or equal to $1E-4$, then capping of the EU will be considered to be an acceptable remedy for the Composite Worker. For the Construction Worker, cumulative cancer risks exceeding $1E-5$, but less than or equal to $1E-4$, will be mitigated via site-specific health and safety requirements. The efficacy of capping for elevated non-cancer hazard will be evaluated in terms of the magnitude of exceedance and other factors such as bioavailability of the COPC. Similarly, for lead, if the ALM results indicate that the mean concentrations would present a 5% to 10% probability of a blood concentration of 10 ug/dL for the EU, then capping of the EU would be an acceptable presumptive remedy. The mean soil lead concentrations corresponding to ALM probabilities of 5% and 10% are 2,518 mg/kg, and 3,216 mg/kg, respectively. If capping of the identified area is not proposed, additional more detailed quantitative evaluation of risk will be required for the EU. This supplemental risk evaluation could include a selective removal (excavation) remedy to reduce site-wide cancer risks and/or non-cancer hazards to acceptable levels.

The USEPA's acceptable risk range is between $1E-6$ and $1E-4$. If the sum of the risk ratios for carcinogens exceeds a cumulative cancer risk of $1E-4$, further analysis of site conditions will be required including the consideration of toxicity reduction in any proposal for a remedy. The magnitude of non-carcinogen hazard exceedances and bioavailability of the COPC will also dictate further analysis of site conditions including consideration of toxicity reduction in any proposal for a remedy. In addition, if the ALM indicates that the mean concentrations would present a >10% probability of a blood concentration of 10 ug/dL for the EU, further analysis of site conditions including toxicity reduction will be completed such that the probability would be reduced to less than 10% after toxicity reduction, but before capping.

3.3.2. Sub-Parcel B2-1 SLRA Results and Risk Characterization

Soil data were divided into three datasets (surface, subsurface, and pooled) for the site-wide EU to evaluate potential current and future exposure scenarios. The current Composite Worker will be exposed only to surface soils. However, if construction activities were to result in the placement of subsurface material over existing surface soils, a future Composite Worker could be exposed to a mixture of surface and subsurface soils. The Construction Worker may be exposed only to surface soils, but subsurface soils would be encountered for development activities that involve soil disturbances such as excavations or other intrusive earth-moving activities. Pooled data may be applicable for development work that involves disturbances through the surface soil, since workers would likely not be exposed solely to the subsurface soil. Only limited intrusive activities are planned for this development of Sub-Parcel B2-1.

EPCs were calculated for each COPC soil dataset (i.e., surface, subsurface, and pooled surface/subsurface) in the site-wide EU. ProUCL output tables (with computed UCLs) derived from the data for each COPC in soils are provided as electronic attachments, with computations presented and EPCs calculated for COPCs within each of the three datasets. The ProUCL input tables are also included as electronic attachments. The results were evaluated to identify any samples that may require additional assessment or special management based on the risk characterization approach. The calculated site-wide EPCs for the surface and subsurface exposure scenarios are provided in **Table 6**. The supplemental EPCs generated from the pooled surface and subsurface soils are also included in the EPC table. These EPCs were used for both the Composite Worker and Construction Worker risk assessments.

As indicated above, the EPCs for lead are the average (i.e., arithmetic mean) values for each dataset. A lead evaluation spreadsheet, providing the computations used to determine lead averages for each dataset in the site-wide EU, is also included as an electronic attachment. The average lead concentrations are presented for each dataset in **Table 5**, which indicates that neither surface, subsurface, nor pooled soils exceeded an average lead value of 800 mg/kg. The screening criterion for lead was set at an EU arithmetic mean of 800 mg/kg based on the RSL, with a secondary limit of 2,518 mg/kg based on the May 2017 updated ALM developed by the USEPA (corresponding to a 5% probability of a blood lead level of 10 ug/dL). There were no locations where detections of lead exceeded 10,000 mg/kg.

None of the detections of PCBs at the Site exceeded the mandatory excavation criterion of 50 mg/kg or any of the applicable PALs.

Composite Worker Assessment:

Risk ratios for the estimates of potential EPCs for the Composite Worker scenario are shown in **Table 7** (surface), **Table 8** (subsurface), and **Table 9** (pooled surface and subsurface soils). The results are summarized as follows:

Development Exposure Unit			
Worker Scenario	Medium	Hazard Index (>1)	Total Cancer Risk
Composite Worker	Surface Soil	none	3E-6
	Subsurface Soil	none	5E-6
	Surface & Subsurface Soil	none	4E-6

The current Composite Worker will be exposed only to surface soils. Construction activities could result in the placement of subsurface material over existing surface soils exposing a future Composite Worker to a mixture of surface and subsurface soils. The risk ratios indicated that the cumulative cancer risks for the Composite Worker were equal to 3E-6 for surface soils, 5E-6 for subsurface soils, and 4E-6 for pooled (surface and subsurface) soils. For this Composite Worker evaluation, no target organs had a cumulative non-cancer HI above 1 for the site-wide EU.

The carcinogenic risk estimates for the Composite Worker did not exceed 1E-5, and no target organs exceeded a cumulative HI of 1. Thus, conditions at the Site are below the acceptable limits for no further action defined in the Risk Characterization Approach. Based on the risk ratios for Sub-Parcel B2-1, no further action is required to be protective of current or future Composite Workers either before or after the proposed development. No capping remedy is required for this project.

Construction Worker Assessment:

According to the work schedule provided by Tradepoint Atlantic, intrusive activities (i.e., activities that involve disturbances of potentially impacted soil performed by Construction Workers outside of enclosed vehicle cabs) are expected to be limited to three primary tasks which will be conducted concurrently between July 9 and August 31, 2018:

- Transformer Foundations
- Circuit Breaker Foundations
- Ductbank Installation

Although the anticipated work period may be subject to change, the duration of intrusive activities is not expected to increase. Each of these primary tasks (along with other minor tasks) will be performed by a separate work crew. The proposed division of labor between the crews,

as provided by Tradepoint Atlantic, is included as **Appendix B**. As shown in the appendix, no individual work crew will exceed an exposure duration of 28 intrusive days. Construction Worker risk ratios were evaluated for several exposure scenarios to determine the exposure frequency for the site-wide EU that would result in risk ratios equivalent to a cumulative cancer risk of 1E-5 or HI of 1 for any individual target organ. Risk ratios for the estimates of potential EPCs for the Construction Worker scenario using the selected exposure duration (45 work days) are shown in **Table 10** (surface), **Table 11** (subsurface), and **Table 12** (pooled surface and subsurface soils). The variables entered for calculation of site-specific Construction Worker SSLs (EU area, input assumptions, and exposure frequency) are indicated as notes on the tables. The spreadsheet used for computation of the site-specific Construction Worker SSLs is included in **Appendix C**. The results of the 45-day exposure scenario are summarized as follows:

Development Exposure Unit			
Worker Scenario	Medium	Hazard Index (>1)	Total Cancer Risk
Construction Worker (45 work day schedule)	Surface Soil	none	1E-7
	Subsurface Soil	none	2E-7
	Surface & Subsurface Soil	none	2E-7

Using the 45-day exposure duration, the carcinogenic risks were computed to be 1E-7 for the surface exposure scenario and 2E-7 for the subsurface and pooled scenarios. These computed risks were all less than the acceptable no further action limit (1E-5) as defined in the Risk Characterization Approach. In addition, none of the non-carcinogens caused a cumulative HI to exceed 1 for any target organ system using the 45-day exposure frequency. This assessment indicates that site-specific health and safety protocols or further action would be required for the proposed construction only if intrusive activities exceed 45 work days for an individual worker. Intrusive activities are defined in this RADWP as any construction activity that involves the disturbance of potentially impacted soil performed by Construction Workers outside of enclosed vehicle cabs. If the duration of intrusive work would exceed the specified limit of 45 days, the work would need to be completed by another crew, or additional health and safety protections would be required.

Based on the anticipated exposure durations given in **Appendix B**, the duration of intrusive work will not exceed the allowable limit of 45 days for any individual or crew. Therefore, general health and safety controls used by Construction Workers (level D protection) are adequate to mitigate risk to Construction Workers for the proposed work. Institutional controls will be required to be established for the protection of future Construction Workers in the event of any future long-term development which could include intrusive activities. These institutional controls will need to include a written notice to the MDE of any future soil disturbance activities, health and safety requirements for any excavations, and proper management and characterization of any removed material.

3.3.3. Evaluation of Comprehensive Environmental Response, Compensation, and Liability (CERCLA) Criteria

Results from the SLRA indicate that no further action is required within the proposed development area to mitigate potential current and future Composite Worker risks. Site-specific health and safety controls will not be required to mitigate Construction Worker risks within the sub-parcel because the proposed schedule of work will not exceed the allowable limit of 45 intrusive work days. The proposed development will include minor grading and the construction of an electrical substation, as shown on the development plan drawings (**Appendix D**). Since the Composite Worker and Construction Worker scenarios were below the criteria requiring additional mitigative responses, no additional protections for the potential current and future Composite Worker and Construction Worker are warranted (beyond protective institutional controls for the Construction Worker).

The undisturbed scenario (i.e., the scenario which does not require a capping remedy) has been evaluated for consistency with the CERCLA Threshold Criteria and the Balancing Criteria as described below. The Threshold Criteria assess the overall protection of human health and the environment, the achievement of media cleanup objectives, and the control of sources of releases at the Site. The Balancing Criteria assess long-term effectiveness and permanence; reduction of toxicity, mobility or volume; short-term effectiveness; implementability; cost effectiveness; and community and State acceptance.

Threshold Criteria:

Protect Human Health and the Environment: The assessment against this criterion evaluates how the undisturbed scenario, as a whole, protects and maintains protection of human health and the environment. The undisturbed scenario evaluated in the SLRA indicates that risks to current and future industrial workers are acceptable despite a limited number of detections of soil constituents in excess of the Composite Worker RSLs. Groundwater does not present a human health hazard since there is no groundwater use. Implementation of the proposed institutional controls will address the residual risk and will also protect hypothetical future Construction Workers by eliminating or controlling potential exposure pathways, thus reducing potential intake and contact of soil and groundwater COPCs by human receptors.

Achieve Media Cleanup Objective: The assessment against this criterion describes how the undisturbed scenario meets the cleanup objective, which is risk reduction, appropriate for the expected current and reasonably anticipated future land use. The objective is to protect workers (current and future Composite Worker and Construction Worker) from potential exposures to site-related soil or groundwater constituents at levels that may result in risks of adverse health effects. Given the controlled access and use restrictions, the proposed undisturbed scenario will attain soil and groundwater objectives.

Control the Source of Releases: In its RCRA Corrective Action proposed remedies, USEPA seeks to eliminate or reduce further releases of hazardous wastes or hazardous constituents that may pose a threat to human health and the environment. Controlling the sources of contamination relates to the ability of the undisturbed scenario to reduce or eliminate, to the maximum extent practicable, further releases. None of the soils remaining on-site were identified as exhibiting characteristics of hazardous waste. Sampling results did not indicate localized, discernible source areas associated with the soil conditions observed at the Site, with the possible exception of NAPL at one boring to the east of the development boundary (B2-051-SB). The control measures included with the proposed undisturbed scenario, such as Materials Management Plan requirements and groundwater use restrictions, provide a mechanism to control and reduce potential further releases of COPCs. This is achieved by eliminating the potential for groundwater use and requiring proper planning associated with future intrusive activities.

Balancing Criteria:

Long-Term Reliability and Effectiveness: The assessment against this criterion evaluates the long-term effectiveness of the undisturbed scenario in maintaining protection of human health and the environment. The primary focus of this criterion is the extent and effectiveness of the controls that may be required to manage the risk posed by treatment residuals and/or untreated wastes. The Composite Worker evaluation indicated no long-term risks for an industrial worker which might require mitigation. Institutional controls (deed restrictions) will be implemented to protect future Construction Workers against disturbances of the soil that might lead to inadvertent long-term contact with potentially impacted soils or groundwater. These institutional controls are anticipated to include a restriction prohibiting the use of groundwater for any purpose, a written notice to the MDE of any future soil disturbance activities, health and safety requirements for any excavations, and proper management and characterization of any removed material. The Tenant will be required to sign onto the Environmental Covenant with restriction in the No Further Action Letter (NFA). The long-term effectiveness is high, as institutional controls are readily implementable and easily maintained. Given the historical, heavily industrial uses of the Site and the surrounding area, including the presence of landfills, industrial land uses of this area and existing groundwater use restrictions are expected to continue in the long-term.

Reduction of Toxicity, Mobility, or Volume of Waste: The assessment against this criterion evaluates the anticipated performance of specific technologies that a remedial action alternative may employ. A cap is not necessary to reduce toxicity, mobility, or volume of waste in this case. No capping remedy is proposed for this Site.

Short-term Effectiveness: The assessment against this criterion examines how well the proposed undisturbed scenario protects human health and the environment during the construction and implementation. This criterion also includes an estimate of the time required to achieve protection for either the entire site or individual elements associated with specific site areas or threats. The results of the SLRA indicate that risks to the Construction Worker during implementation are mitigated by limiting workers to the specific exposure duration given in the SLRA (45 days). The short-term risk to site workers following general health and safety measures during implementation of the remedy will be low. Short-term effectiveness in protecting on-site workers and the environment will be achieved through establishing appropriate management, construction, health and safety, and security procedures. Proper water management protocols will be implemented to prevent discharges offsite. Security and fences will be used to maintain controlled access during construction to be protective of site visitors.

Implementability: The assessment against this criterion evaluates the technical and administrative feasibility, including the availability of trained and experienced personnel, materials, and equipment. Technical feasibility includes the ability to construct and operate the technology, the reliability of the technology, and the ability to effectively monitor the technology. Administrative feasibility includes the capability of obtaining permits, meeting permit requirements, and coordinating activities of governmental agencies. There are no concerns related to implementability in this case.

Cost Effectiveness: The assessment against this criterion evaluates the capital costs, annual Operating and Maintenance (O&M) costs, and the net present value (NPV) of this remedy relative to other alternatives. The undisturbed scenario does not have an associated remedial cost, regardless of the presence of soil containing COPCs.

State/Support Agency Acceptance: MDE has been involved throughout the Site investigation process. The proposed use restrictions included in this RADWP are generally recognized as commonly employed measures for long-term stewardship. Ultimately State/MDE support will be evaluated based on comments received during the public comment period.

The undisturbed scenario with institutional controls will satisfy the CERCLA Threshold Criteria and Balancing Criteria and will do so in a manner that ensures rapid and reliable implementation and effectiveness. The undisturbed scenario is cost-effective and consistent with the proposed development plan for the Site.

4.0 PROPOSED SITE DEVELOPMENT PLAN

Tradepoint Atlantic is proposing to construct an electrical substation on Sub-Parcel B2-1. Included will be improvements on approximately 7.2 acres of land in the northwestern portion of Parcel B2. The proposed future use is Tier 3B – Restricted Industrial. The remainder of Parcel B2 will be addressed in additional separate development plans in accordance with the requirements of the ACO that will include RADWPs, if necessary.

Certain compounds (inorganics) are present in the soils located near the surface and in the subsurface at concentrations in excess of the PALs. Therefore, soil is considered a potential media of concern. Future adult Composite Workers could potentially contact surface soil during normal duties conducted at the Site. Future Construction Workers may contact impacted surface and/or subsurface soil during earth movement activities associated with future construction activities.

The SLRA has indicated no potential risks to future adult Composite Workers associated with impacts to soil exceeding the PALs. General health and safety controls (level D protection) outlined in the property-wide Health and Safety Plan (HASP provided in **Appendix E**) will mitigate any potential risk to Construction Workers from contacting impacted soil and groundwater during development at the Site. The findings of the SLRA indicated that the screening level estimate of Construction Worker cancer risk for the site-specific 45-day exposure frequency was less than 1E-5 (the acceptable level for no further action). Furthermore, no potential non-cancer hazards above the HI of 1 were identified for any target organ in the development area using the 45-day exposure frequency. If the schedule of site-wide intrusive activities for an individual worker exceeds 45 days, additional site-specific health and safety requirements will be warranted.

A restriction prohibiting the use of groundwater for any purpose at the Site will be included as an institutional control in the No Further Action Letter (NFA) and Certificate of Completion (COC) issued by the MDE, and a deed restriction prohibiting the use of groundwater will be filed. These groundwater use restrictions will protect future Composite Workers from potential exposures. Proper water management is required to prevent unacceptable discharges or risks to Construction Workers during development. Work practices and health and safety plans governing groundwater encountered during excavation activities will provide protection for Construction Workers involved with future development at the Site.

The proposed Sub-Parcel B2-1 Development Area, approximately 7.2 acres, will remain uncapped with only minor grading. The electrical substation and support facilities will be constructed in the graded development area. The development plan for the Site is indicated in **Figure 2**. The process of constructing the proposed substation involves the tasks listed below. As-built and regulatory documentation for the outlined tasks and procedures will be provided in a Sub-Parcel B2-1 Development Completion Report:

- **RESPONSE PHASE**

- 1. Well Abandonment**

Shallow groundwater monitoring well SW-058-MWS, which is located inside the development boundary shown on **Figure 6**, will be properly abandoned in accordance with COMAR 26.04.04.34 through 36. This abandonment should be completed prior to starting construction in the vicinity of the well to ensure that the flush mount pad is not destroyed or covered prior to abandonment. If the monitoring well cannot be abandoned prior to the start of construction, temporary protective measures (flagging, barriers, etc.) may be installed as necessary to protect the integrity of the well during grading. The remaining monitoring wells located outside of the development boundary will be maintained in their current condition.

SW-058-MWS was previously sampled during the Area B Groundwater Investigation. A summary of the analytical results from this location are provided in **Table 3** of this RADWP, and the aqueous PAL exceedances are displayed on **Figure 6**. There is no potential for direct human exposure to groundwater for a future Composite Worker since groundwater is not used on the Tradepoint Atlantic property (and is not proposed to be utilized). In the event that construction/excavation work associated with development leads to a potential Construction Worker direct exposure to groundwater, health and safety plans and procedures shall be followed to limit exposure risk. Based on the minor nature of the PAL exceedances at this location, and the lack of exposure risks for current and future workers, it is appropriate to abandon this monitoring well.

- **DEVELOPMENT PHASE**

- 1. Erosion and sediment control installation for development.**

Installation of erosion and sediment controls will be completed in accordance with the requirements of the 2011 Maryland Standards and Specifications for Soil Erosion and Sediment Control prior to any construction at the Site. Any soils which are disturbed during the installation of erosion and sediment controls will be replaced on-site and compacted (i.e., may be placed at or near the surface but must be managed to prevent erosion).

- 2. Grading and site preparation.**

As indicated on the development plans in **Appendix D**, minor site grading will occur within the Sub-Parcel B2-1 boundary. Any material that is not suitable for compaction below proposed structures will be excavated and replaced with subbase material, although it is not anticipated that poor soils will be encountered. Borrow materials, if necessary, will be obtained from MDE-approved sources and may include clean fill approved for industrial use and (subject to testing and approval) processed slag aggregate sourced from the Tradepoint Atlantic property. These sources shall be free of organic material, frozen material, or other deleterious material. In the case that there is excess material, the spoils will be stockpiled at a

suitable location in accordance with the Materials Management Plan (MMP) for the Sparrows Point Facility (Papadopoulos & Associates, et al., June 17, 2015). This work will be coordinated with MDE accordingly. No excess material will leave the 3,100 acre property without prior approval from the MDE.

3. Installation of structures and underground utilities.

The structures associated with the proposed electrical substation will be installed at the grades and lines shown on the development plans in **Appendix D**. Soils relocated or removed during the construction of the substation structures and utilities may be replaced on-site and compacted, but soil removed from utility trenches cannot be used as fill within the utility trenches unless such materials have been approved for this use by the VCP. Additional protocols for the installation of utilities at the Site are provided in Section 5.1.1.

Any water removed will be collected to be sampled as described in Section 5.2 and, if acceptable, taken to the on-site wastewater treatment plant. If analytical results indicate the presence of levels of contaminants exceeding levels that are acceptable for treatment at the wastewater treatment plant (as defined in Section 5.2), the water will either be pre-treated through an on-site treatment system and retested prior to pumping to the wastewater treatment plant or will be disposed of at an appropriate off-site facility.

4. Stormwater management.

A stormwater management plan for the Site is provided with the development plan drawings in **Appendix D**. Tradepoint Atlantic will work with the MDE Industrial & General Permits Division in 2018 to renew the property-wide NPDES permit. A meeting has already been conducted for this purpose. The stormwater management systems for each parcel are reviewed and approved by Baltimore County for each individual development project. A full plan for the property will be designed once more parcels have been completed and there is a greater understanding of how the overall property will be developed. The agencies will be copied when the management plan is submitted.

5.0 DEVELOPMENT IMPLEMENTATION PROTOCOLS

5.1. DEVELOPMENT PHASE

This plan presents protocols for the handling of soils and fill materials in association with the development of Sub-Parcel B2-1. In particular, this plan highlights the minimum standards for construction practices and managing potentially contaminated materials to reduce potential risks to workers and the environment.

Several exceedances of the PALs were identified in soil samples across the Site. The PALs are set based on USEPA's RSLs for industrial soils, or other direct guidance from the MDE. Because PAL exceedances can present potential risks to human health and the environment at certain concentrations, this plan presents material management and other protocols to be followed during the work to adequately mitigate such potential risks for material remaining on-site during the development phase. Following completion of the SLRA, the screening level estimate of Construction Worker cancer risk for the site-specific 45-day exposure frequency was less than $1E-5$ (the acceptable level for no further action) for the site-wide EU. Furthermore, none of the potential non-cancer hazards were elevated above the HI of 1 for any exposure scenario when the schedule for intrusive construction activities was limited to 45 days. Since the cumulative duration of intrusive work is not expected to exceed 45 days for an individual worker, general worker protective controls (Level D) and health and safety measures will be sufficient for the proposed development schedule with no additional site-specific requirements.

5.1.1. Soil Excavation and Utility Trenching

A pre-excavation meeting shall be held to address proper operating procedures for working on-site and monitoring excavations and utility trenching in potentially contaminated material. This meeting shall include the construction manager and the Environmental Professional (EP) providing oversight on the project. During the meeting, the construction manager and the EP shall review the proposed excavation and trenching locations and any associated utility inverts. The construction manager will be responsible for conveying all relevant information regarding excavation/grading and/or utility work to the site workers who will be involved with these activities. There was one boring location with potential evidence of NAPL identified during the preceding Parcel B2 Phase II Investigation within a reasonable proximity to the development area (B2-051-SB). However, because the evidence in soil was minor and a temporary screening piezometer installed at this location did not accumulate NAPL, no special considerations are required prior to work other than review of the NAPL Contingency Plan discussed below. The HASP for the project shall also be reviewed and discussed.

Key soil excavation activities will be monitored through daily inspections by the EP. Soil excavation and removal activities will occur during utility trenching, facility construction, and grading. In general, and based on the existing sampling information, all excavated materials are

expected to be suitable for replacement on the Site. However, the EP will monitor all soil excavation activities for signs of potential contamination that may not have been previously identified (as described below).

To the extent practical, all excavation activities should be conducted in a manner to minimize double or extra handling of materials. Any stockpiles shall be kept within the Site footprint, and in a location that is not subjected to concentrated stormwater runoff. Stockpiles shall be managed as necessary to prevent the erosion and off-site migration of stockpiled materials, and in accordance with the applicable provisions of the 2011 Maryland Standards and Specifications for Soil Erosion and Sediment Control. Soil designated for replacement on-site which does not otherwise exhibit evidence of contamination (as determined by the EP) may be managed in large stockpiles (no size restriction) as long as they remain within the erosion and sediment controls.

All utility trenches will be backfilled with bedding and backfill materials approved by the MDE for industrial use. A general utility cross section is provided as **Appendix F**. Additional preventative measures will be required if evidence of petroleum contamination is encountered, to prevent the discharge to, or migration of, petroleum product along a utility conduit. Contingency measures have been developed to ensure that utilities will be constructed in a manner that will prevent the migration of any encountered NAPL, and that excavated material will be properly managed. The Utility Excavation NAPL Contingency Plan (**Appendix G**) provides protocols to be followed if NAPL is encountered during the construction activities. Preventative measures to inhibit the spread of petroleum product will be conducted in accordance with this plan.

The EP will monitor all soil excavation and utility trenching activities for signs of potential contamination that may not have been previously identified. In particular, soils will be monitored with a hand-held PID for potential VOCs, and will also be visually inspected for the presence of staining, petroleum waste materials, or other indications of contamination that may be different than what was already characterized. If screening of excavated materials by the EP indicates the presence of conditions of potential concern (i.e., sustained PID readings greater than 10 ppm, visual staining, unsuitable waste materials, etc.), such materials shall be segregated for additional sampling and special management. Excavated material exhibiting possible evidence of contamination should be placed in stockpiles (not to exceed 500 cubic yards) on polyethylene sheeting and covered with polyethylene sheeting to minimize potential exposures and erosion when not in use. Stockpiled materials will be sampled in accordance with waste disposal requirements, and properly transported to an appropriate permitted disposal facility. Plans for analysis of segregated soils for any use other than disposal must be submitted to the MDE for approval.

Excavated material that is visibly impacted by NAPL will be segregated and managed in accordance with the requirements specified in the Utility Excavation NAPL Contingency Plan. Excavated material with indicators of possible NAPL contamination will also be containerized or placed in a stockpile (not to exceed 500 cubic yards) on polyethylene sheeting and covered with

polyethylene sheeting until the material can be analyzed for TPH/Oil & Grease and PCBs (total) to characterize the material for appropriate disposal. The MDE will be notified if such materials are encountered during excavation or utility trenching activities.

5.1.2. Soil Sampling and Disposal

Excavated materials that are determined by the EP to warrant sampling and analysis because of elevated PID readings or other indicators of potential contamination that has not previously been characterized shall be sampled and analyzed to determine how the materials should be managed. If excavated and stockpiled, such materials should be covered with a polyethylene tarp to minimize potential exposures and erosion. A sampling work plan including a description of the material, estimated volume, and sampling parameters will be submitted to the MDE for approval. All excavated soil may be considered for use as on-site fill depending on the analytical results. All analytical data for the stockpiled material will be evaluated according to the standard Composite Worker SLRA analysis process. Following calculation of Composite Worker risk ratios for the stockpiled materials, if the cancer risk is less than or equal to $1E-5$, and the non-cancer hazards (evaluated in terms of the magnitude of the exceedance and other factors such as bioavailability of the COPC) are acceptable, the excavated soil will be replaced on-site. If the cancer risk exceeds $1E-5$ but is less than or equal to $1E-4$ (and the non-cancer hazards are acceptable), the stockpiled soil will be suitable for use as fill in other areas of the Tradepoint Atlantic property under VCP caps. Otherwise, the materials will be sampled to determine if they would be classified as hazardous waste for disposal.

Soil material that is determined to be a hazardous waste shall be shipped off-site in accordance with applicable regulations to an appropriate and permitted RCRA disposal facility. Soil material may be taken to the on-site landfill (Greys) for proper disposal if the concentrations of excavated sampled materials indicate that the materials are not hazardous, but still are not suitable for reuse. The quantities of all materials that require disposal either off-site or at the on-site landfill, if any, will be recorded and identified in the Development Completion Report.

5.1.3. Fill

MDE-approved materials, which may include clean fill approved for industrial use and (subject to testing and approval) processed slag aggregate sourced from the Tradepoint Atlantic property, will be used as compacted subbase for the electrical substation if suitable material is not present on-site. Soil excavated on the sub-parcel has been determined to be suitable for re-use. As described in the SLRA, the risk ratios for COPCs in the Sub-Parcel B2-1 Development Area indicate that soil contaminant concentrations do not exceed acceptable risk levels for current and future Composite Workers. All over-excavated utility trenches will be backfilled with bedding and backfill approved by the MDE for industrial use. Any clean fill material imported to the Site will be screened according to MDE guidance for suitability.

5.1.4. Erosion/Sediment Control

Erosion and sediment controls will be installed prior to commencing work in accordance with 2011 Maryland Standards and Specifications for Soil Erosion and Sediment Control. The erosion and sediment controls will be approved by the Baltimore County Soil Conservation District. In addition, the following measures will be taken to prevent contaminated soil from exiting the Site:

- Stabilized construction entrance will be placed at site entrance.
- A dry street sweeper will be used as necessary on adjacent roads, and the swept dust will be collected and properly managed.
- Accumulated sediment removed from silt fence, and sediment traps if applicable, shall be periodically removed and returned to the Site.

5.1.5. Dust Control

General construction operations, including soil excavation and transport, soil grading, and trenching for utilities will be performed at the Site. These activities are anticipated to be performed in areas of soil impacted with COPCs. Best management practices should be undertaken at the Sparrows Point property as a whole to prevent the generation of dust which could impact other areas of the property outside of the immediate work zone. To limit worker exposure to contaminants borne on dust and windblown particulates, dust control measures will be implemented, if warranted when the above activities are performed in areas with potentially impacted soil. The action level proposed for the purpose of determining the need for dust suppression techniques (e.g. watering and/or misting) and/or continuous monitoring during the development activities at the Site will be 3.0 mg/m³. The lowest of the site-specific dust action levels, OSHA PELs, and ACGIH TLV was selected as the proposed action level.

If visible dust is generated in the breathing zone, air monitoring will be implemented as follows:

- At the start of intrusive activities;
- Periodically during intrusive activities (15-minute intervals);
- When contaminants other than those previously identified are being handled;
- When a different type of operation is initiated or conditions change;
- If personnel are working in areas with obvious particulate contamination; and
- If a sufficient reasonable interval has passed so that exposures may have significantly changed.

Air monitoring will be performed using a ThermoElectron Corporation Personal Data RAM 1000AN dust monitor, a Met One Instruments, Inc. E-Sampler dust monitor, or another equivalent real-time air monitoring device. If the action level (3.0 mg/m^3) is exceeded as a result of conditions occurring at the Site, operations will be stopped and dust suppression implemented. The background dust concentration will be utilized to evaluate whether Site activities are the source of the action level exceedance. Background concentrations will be based on measurements over a minimum of a 1-hour period at the upwind Site boundary. This upwind data will be used to calculate a time weighted average background dust concentration. The background dust concentration may need to be recalculated periodically during the work day, based on changed upwind conditions. Operations may be resumed once monitoring indicates that dust concentrations are below the action level.

As applicable, air monitoring will be conducted during development implementation activities in the immediate work zones and surrounding areas to assess levels of exposure to Site workers, establish that the work zone designations are valid, and verify that respiratory protection being worn by personnel, if needed, is adequate. Concurrent with the work zone air monitoring, perimeter air monitoring will also be performed to ensure contaminants are not migrating off-site. Perimeter monitoring will include monitoring along the perimeter of the Site, including both the downwind and upwind portions of the Site. The concentration measured in the downwind portion of the Site shall not exceed the concentration in the upwind portion. If exceedances attributable to Site conditions are identified downwind for more than five minutes, dust control measures and additional monitoring will be implemented. The dust suppression measures may include wetting or misting through the use of a hose connected to an available water supply or a water truck stationed at the Site.

Dust control measures will be implemented as described above to address dust generated as a result of construction activities conducted at the Site. However, based on the nature of the area and/or on-going activities surrounding the Site, it is possible that windblown particulates may come from surrounding areas. As discussed above, the dust concentration in the upwind portion of the Site will be considered when monitoring dust levels in the work zone. A pre-construction meeting will be held to discuss the potential of windblown particulates from other activities impacting the air monitoring required for this RADWP. Site contact information will be provided to address the possibility of upwind dust impacts. If dust is observed above the action level (3.0 mg/m^3) and it is believed to originate from off-site (i.e., upwind) sources, this will immediately be reported to the MDE-VCP project team, as well as the MDE Air and Radiation Management Administration (ARMA).

5.2. WATER MANAGEMENT

This plan presents the protocols for handling any groundwater or surface water that needs to be removed to facilitate construction of the proposed Sub-Parcel B2-1 development. While it is not

anticipated that groundwater will be encountered during the proposed development, the following measures are provided as contingencies.

5.2.1. Groundwater PAL Exceedances

Aqueous PAL exceedances in groundwater in the vicinity of Sub-Parcel B2-1 included both inorganic and organic compounds, although none of the detections were significantly elevated. The complete analytical findings of the Area B Groundwater Investigation, including results obtained from shallow groundwater points in the vicinity of the Site (FM01-PZM003, SW08-PZM003, and SW-058-MWS) were presented to the agencies in the Area B Groundwater Phase II Investigation Report (Revision 0) dated September 30, 2016. While the concentrations of any PAL exceedances are not deemed to be a significant human health hazard since there is no on-site groundwater use, proper water management is required to prevent unacceptable discharges or risks to on-site workers.

5.2.2. Dewatering

Although dewatering is not anticipated to be necessary for this development project based on the limited scope of subsurface work, the following dewatering requirements are provided as contingencies. If dewatering is required, it shall be done in accordance with all local, state, and federal regulations.

Water that collects in excavations/trenches due to intrusion of groundwater, stormwater, and/or dust control waters will be pumped to the Humphrey Creek Waste Water Treatment Plant (HCWWTP). The water pumped to the HCWWTP will be treated and discharged in accordance with NPDES Permit No. 90-DP-0064A; I. Special Conditions; A.4; Effluent Limitations and Monitoring Requirements.

The EP will inspect the water that collects in the excavations/trenches. If the water exhibits indications of significant contamination (sheen, odor, discoloration, presence of product), or if the excavation/trench is within a known area of significant groundwater contamination (if groundwater is the source of the intrusive water) or a significant Phase II Investigation target, the water may be sampled and analyzed for some or all of the analyses listed below. The analyses run will be dependent on the suspected source of contamination and local site conditions.

The results of the analyses will be reviewed by the HCWWTP operator to determine if any wastewater treatment system adjustments are necessary. If the results of the analyses are above the threshold levels listed below, the water will be further evaluated to confirm acceptable treatment at the HCWWTP, or will be evaluated to design an appropriate pre-treatment option. Alternatively, the water may be disposed of at an appropriate off-site facility.

<u>Analysis</u>	<u>Threshold Levels</u>
• <u>Total metals by USEPA Method 6020A</u>	<u>1,000 ppm</u>
• <u>PCBs by USEPA Method 8082</u>	<u>>Non-Detect</u>
• <u>SVOCs by USEPA Method 8270C</u>	<u>1 ppm</u>
• <u>VOCs by USEPA Method 8260B</u>	<u>1 ppm</u>
• <u>Oil & Grease by USEPA Method 1664</u>	<u>200 ppm</u>

Documentation of any water testing, as well as the selected disposal option, will be reported to the MDE in the Development Completion Report.

5.3. HEALTH AND SAFETY

A property-wide Health and Safety Plan (HASP provided as **Appendix E**) has been developed and is attached to this plan to present the minimum requirements for worker health and safety protection for the project. All contractors working on the Site must prepare their own HASP that provides a level of protection at least as much as that provided by the attached HASP. Alternately, on-site contractors may elect to adopt the HASP provided.

Prior to commencing work, the contractor must conduct an on-site safety meeting for all personnel. All personnel must be made aware of the HASP. Detailed safety information shall be provided to personnel who may be exposed to COPCs. Workers will be responsible for following safety procedures to prevent contact with potentially contaminated soil or groundwater.

5.4. INSTITUTIONAL CONTROLS (FUTURE LAND USE CONTROLS)

Long-term conditions related to future use of the Site will be placed on the RADWP approval, No Further Action Letter (NFA), and Certificate of Completion (COC). These conditions are anticipated to include the following:

- A restriction prohibiting the use of groundwater for any purpose at the Site and a requirement to characterize, containerize, and properly dispose of groundwater in the event of deep excavations encountering groundwater.
- Notice to MDE prior to any future soil disturbance activities at the Site. This written notice will be required at least 30 days prior to any planned excavation activities.
- Requirement for a HASP in the event of any future excavations at the Site.
- Complete appropriate characterization and disposal of any future material excavated at the Site in accordance with applicable local, state and federal requirements.

The responsible party will file the above deed restrictions as defined by the MDE-VCP in the NFA and COC. The entire property will be subject to the groundwater use restriction.

The Tenant will be required to sign onto the Environmental Covenant with restriction in the NFA. Tradepoint Atlantic will notify the Tenant of this requirement and will provide MDE with contact information for the Tenant prior to issuance of the NFA.

5.5. POST REMEDIATION REQUIREMENTS

Post remediation requirements will include compliance with the conditions specified in the NFA, COC, and the deed restrictions recorded for the Site. Deed restrictions will be recorded within 30 days after receipt of the final NFA. In addition, MDE will be provided with a written notice at least 30 days prior to any planned excavation activities at the Site. Written notice of planned excavation activities will include the proposed date(s) for the excavation, location of the excavation, health and safety protocols (as required), clean fill source (as required), and proposed characterization and disposal requirements.

5.6. CONSTRUCTION OVERSIGHT

Construction Oversight by an EP will ensure and document that the project is built as designed and appropriate environmental and safety protocols are followed. Upon completion, the EP will certify that the project is constructed in accordance with this RADWP. Records shall be provided to document:

- Daily observations of construction activities during site grading
- Compliance with soil screening requirements
- Proper water management, including documentation of any testing and water disposal

6.0 PERMITS, NOTIFICATIONS AND CONTINGENCIES

The participant and their contractors will comply with all local, state, and federal laws and regulations by obtaining any necessary approvals and permits to conduct the activities contained herein.

A grading permit is required if the proposed grading disturbs over 5,000 square feet of surface area or over 100 cubic yards of earth. A grading permit is required for any grading activities in any watercourse, floodplain, wetland area, buffers (stream and within 100 feet of tidal water), habitat protection areas or forest buffer areas (includes forest conservation areas). Erosion and Sediment Control Plans will be submitted to, and approved by, the Baltimore County Soil Conservation District prior to initiation of land disturbance for development.

There are no wetlands identified within the project area and no work will be performed beyond the shoreline so no permits are required from the MDE Water Resources Administration.

Contingency measures will include the following:

1. The MDE will be notified immediately of any previously undiscovered contamination, previously undiscovered storage tanks and other oil-related issues, and citations from regulatory entities related to health and safety practices.
2. Any significant change to the implementation schedule will be noted in the progress reports to MDE.

7.0 IMPLEMENTATION SCHEDULE

Progress reports will be submitted to the MDE on a quarterly basis. Each quarterly progress report will include, at a minimum, a discussion of the following information regarding tasks completed during the specified quarter:

- Development Progress
- Dust monitoring
- Water Management
- Soil Management (imported materials, screening, stockpiling)
- Soil Sampling and Disposal
- Notable Occurrences (if applicable)
- Additional Associated Work (if applicable)

The proposed implementation schedule is shown below:

<u>Task</u>	<u>Proposed Completion Date</u>
Anticipated Plan Approval	May 25, 2018

<u>Task</u>	<u>Proposed Completion Date</u>
Well Abandonment (SW-058-MWS)	June 1, 2018

<u>Task</u>	<u>Proposed Completion Date</u>
Intrusive Activities (Full Scope)	August 31, 2018
Ductbank Installation	October 31, 2018
Site Work	December 31, 2018
Foundations Installation	June 28, 2019
Breakers, Transformers, and Relay Equipment	September 30, 2019
Submittal of Completion Report/Notice of Readiness for Use*	February 2020
Request for a NFA from the MDE	March 2020

Recordation of institutional controls in
the land records office of Baltimore
County

Within 30 days of receiving the approval
of NFA from the MDE

Submit proof of recordation with
Baltimore County

Upon receipt from Baltimore County

*Notice of Readiness for Use shall be prepared by Professional Engineer registered in Maryland and submitted with the Development Completion Report to certify that the work is consistent with the requirements of this RADWP and the Site is suitable for occupancy and use.

FIGURES





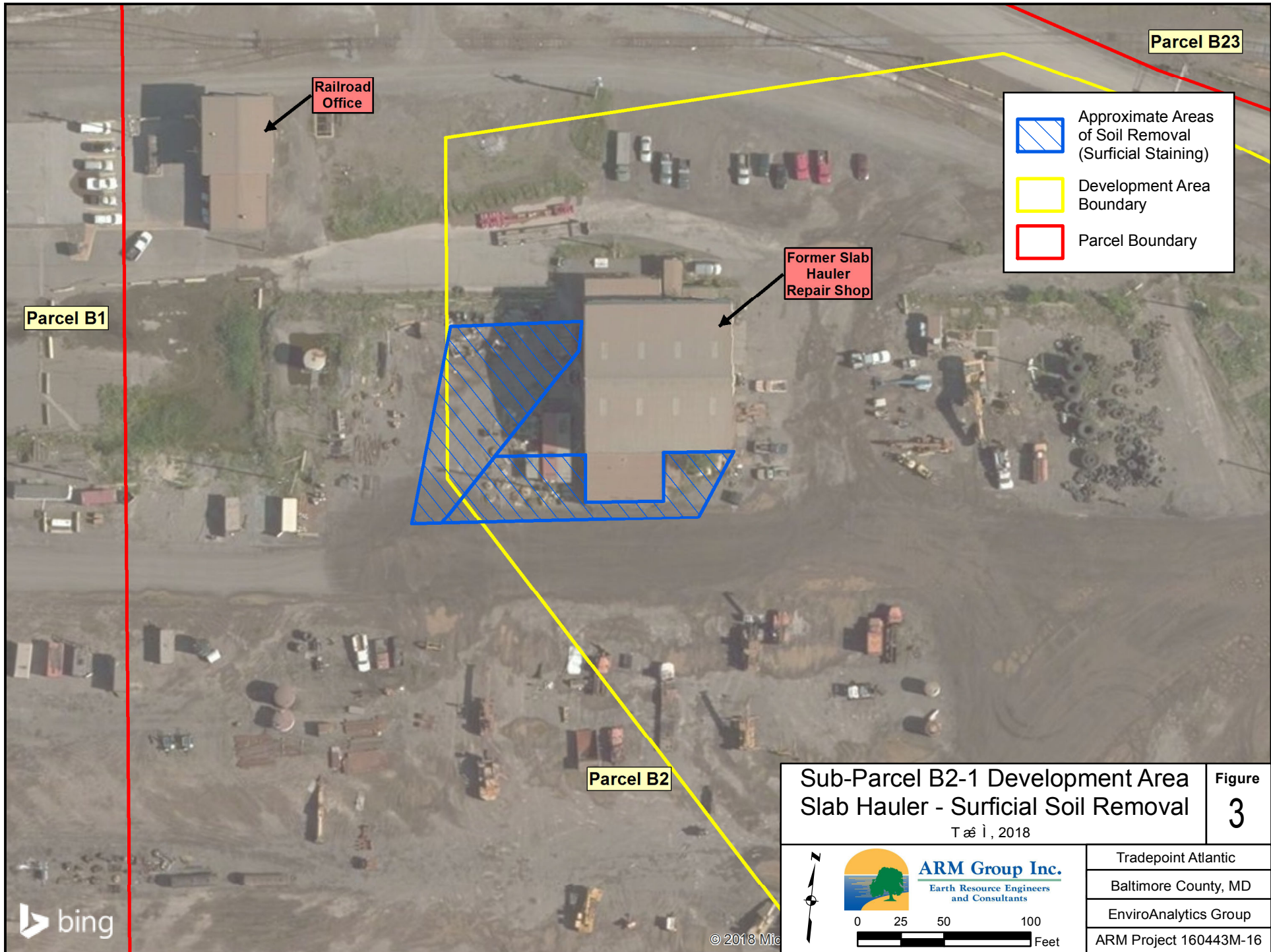

Site Boundary
 Parcel Boundaries
 Private Property

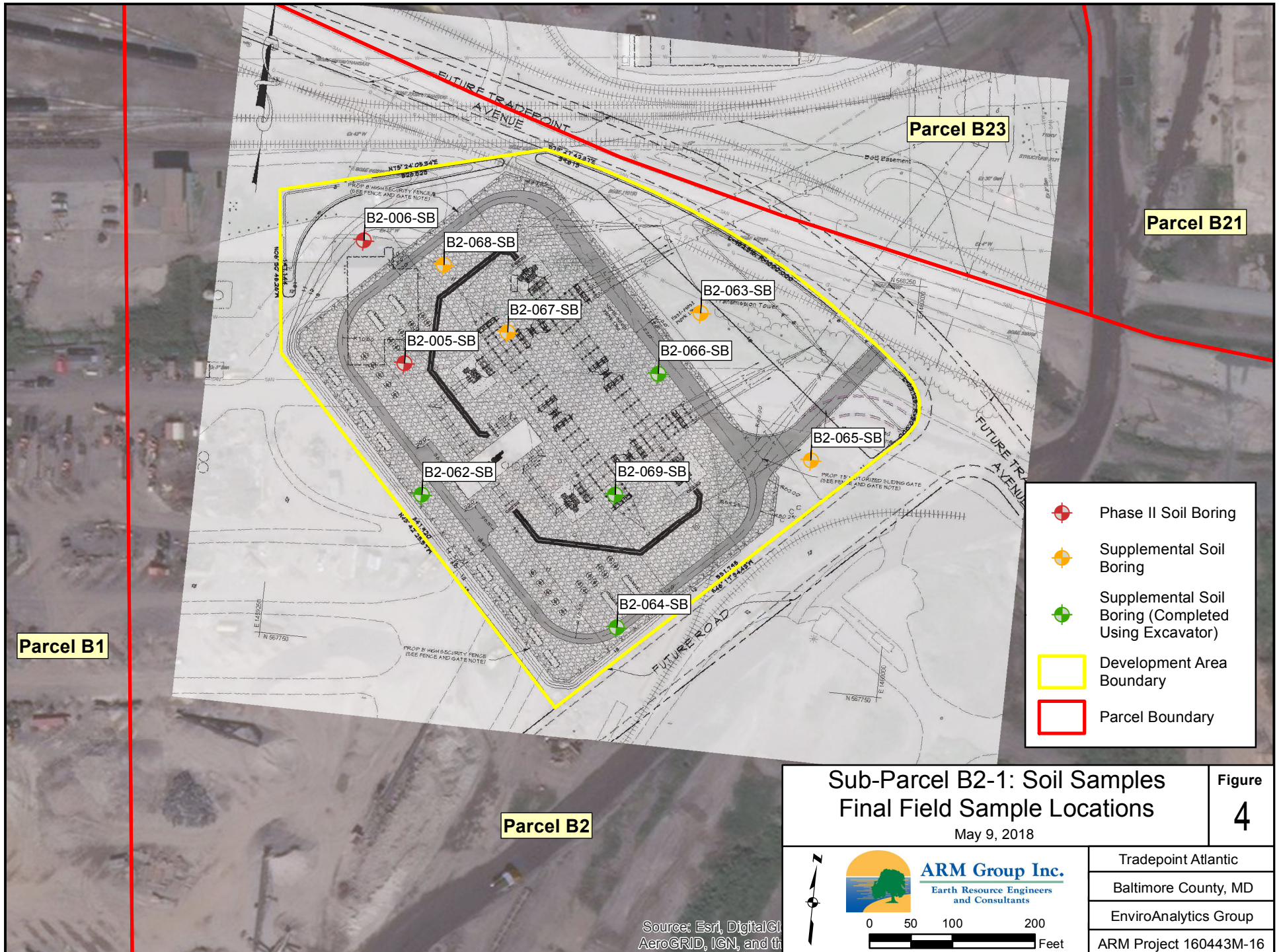
Tradepoint Atlantic Area A and Area B Parcels March 1, 2018		Figure 1
 	 ARM Group Inc. Earth Resource Engineers and Consultants	Tradepoint Atlantic Baltimore County, MD EnviroAnalytics Group
	Area A: Project 150298M Area B: Project 150300M Development: Project 160443M	





-  Phase II Soil Boring
-  Supplemental Soil Boring
-  Supplemental Soil Boring (Completed Using Excavator)
-  Development Area Boundary
-  Parcel Boundary

**Sub-Parcel B2-1: Soil Samples
Final Field Sample Locations**

**Figure
4**

May 9, 2018



ARM Group Inc.
Earth Resource Engineers
and Consultants

0 50 100 200
Feet

Tradepoint Atlantic
Baltimore County, MD
EnviroAnalytics Group
ARM Project 160443M-16

Source: Esri, DigitalGlobe, GeoEye, IGN, and others

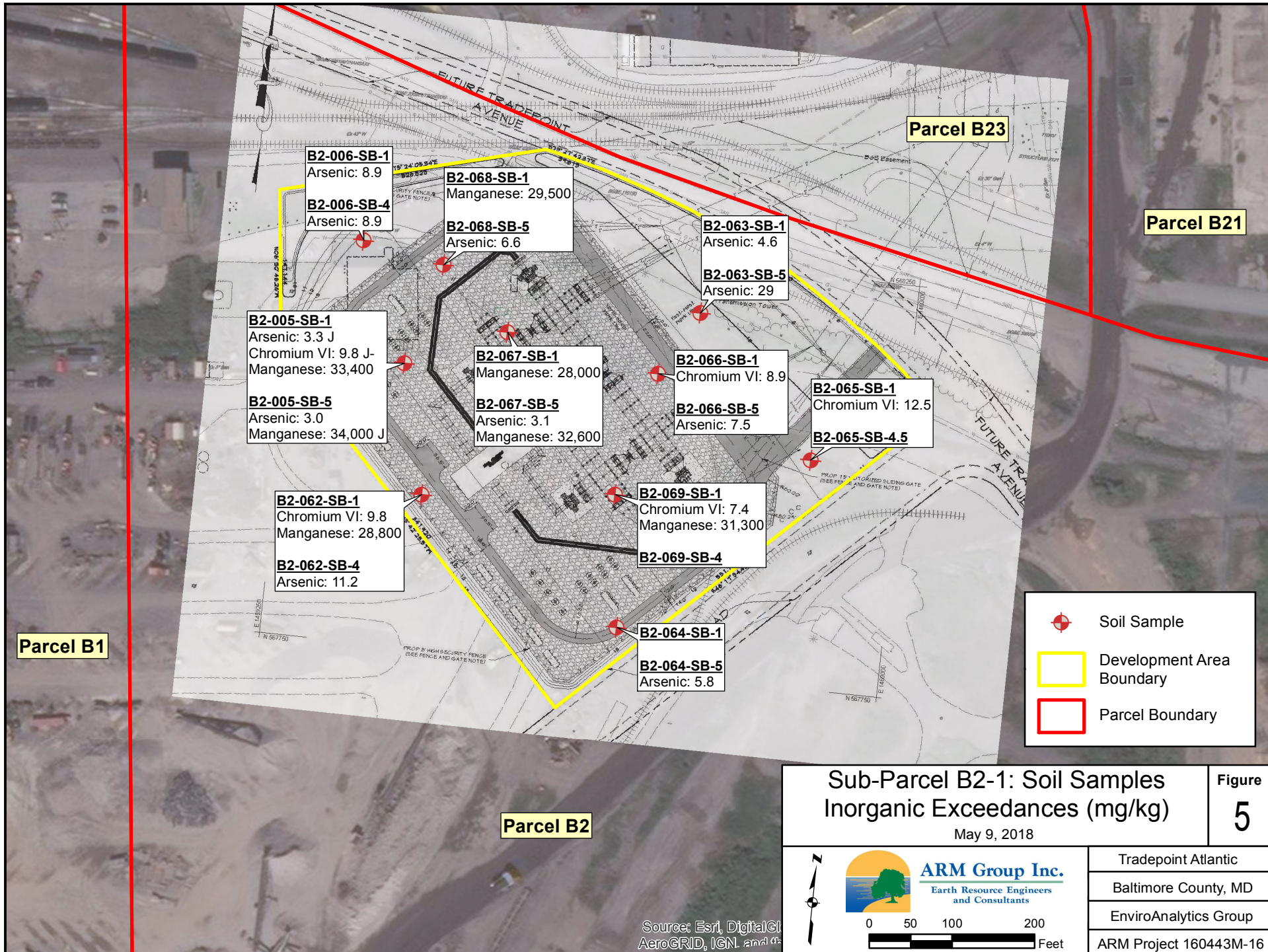

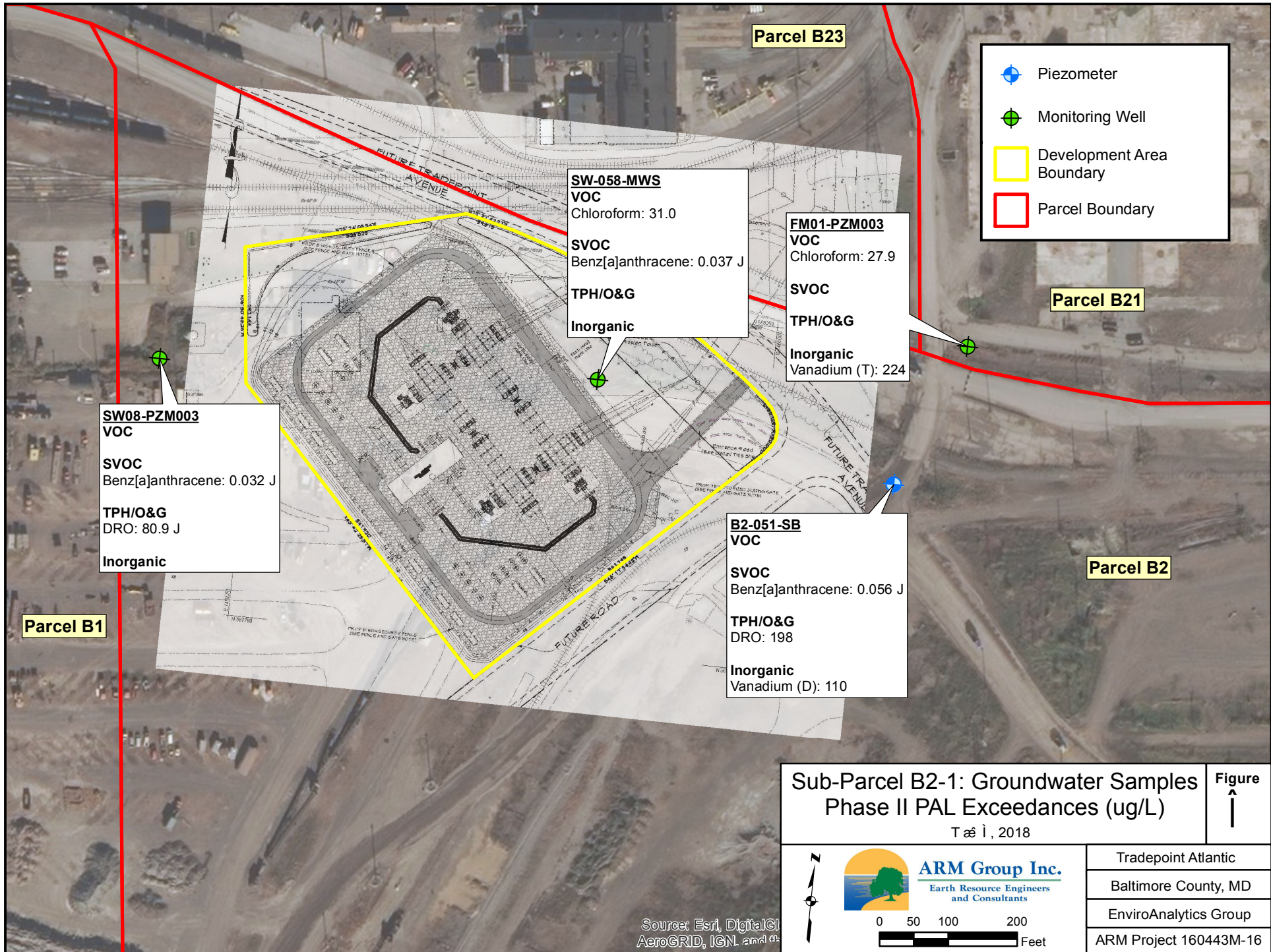

**Sub-Parcel B2-1: Groundwater Samples
 Phase II PAL Exceedances (ug/L)**
 T æ ì , 2018

Figure
 ↑

 ARM Group Inc. Earth Resource Engineers and Consultants	Tradepoint Atlantic
	Baltimore County, MD
	EnviroAnalytics Group
	ARM Project 160443M-16

Source: Esri, DigitalGlobe, GeoEye, IGN, and others

TABLES

Table 1
Summary of Organics Detected in Soil
Sub-Parcel B2-1
Tradeport Atlantic
Sparrows Point, Maryland

Parameter	Units	PAL	B2-005A-SB-1	B2-005-SB-1	B2-005-SB-5	B2-006-SB-1	B2-006-SB-4	B2-062-SB-1*	B2-062-SB-4*	B2-063-SB-1*	B2-063-SB-5*	B2-064-SB-1*	B2-064-SB-5*
Semi-Volatile Organic Compounds^													
1,1-Biphenyl	mg/kg	200	0.073 U	0.074 U	0.073 U	0.022 J	0.063 J	0.071 U	0.019 J	0.73 U	0.08	0.07 U	0.077 U
1,2,4,5-Tetrachlorobenzene	mg/kg	350	0.073 U	0.074 U	0.073 U	0.073 U	0.019 J	0.071 U	0.074 U	0.73 U	0.08 U	0.07 U	0.077 U
2,4-Dimethylphenol	mg/kg	16,000	0.073 UJ	0.074 R	0.073 R	0.073 U	0.059 J	0.071 U	0.074 U	0.73 U	0.08 U	0.07 U	0.077 U
2-Methylnaphthalene	mg/kg	3,000	0.0064 J	0.074 U	0.0062 J	0.19	0.6	0.001 J	0.052	0.085	0.21	0.0012 J	0.042
2-Methylphenol	mg/kg	41,000	0.073 UJ	0.074 R	0.073 R	0.073 U	0.039 J	0.071 U	0.074 U	0.73 U	0.08 U	0.07 U	0.077 U
3&4-Methylphenol(m&p Cresol)	mg/kg	41,000	0.15 UJ	0.15 R	0.15 R	0.15 U	0.12 J	0.14 U	0.15 U	1.5 U	0.03 J	0.14 U	0.15 U
Acenaphthene	mg/kg	45,000	0.0008 J	0.074 UJ	0.0073 UJ	0.058 J	0.044 J	0.0072 U	0.0067 J	0.038	0.018	0.0071 U	0.011
Acenaphthylene	mg/kg	45,000	0.0091	0.074 UJ	0.0073 UJ	0.17	0.12	0.00056 J	0.068	0.31	0.035	0.0006 J	0.59
Acetophenone	mg/kg	120,000	0.073 U	0.074 U	0.073 U	0.02 J	0.045 J	0.071 U	0.074 U	0.73 U	0.048 J	0.07 U	0.077 U
Anthracene	mg/kg	230,000	0.0058 J	0.0043 J	0.0036 J	0.33	0.22	0.00064 J	0.088	0.49	0.073	0.00066 J	0.58
Benz[a]anthracene	mg/kg	21	0.019	0.019 J	0.013	0.91	0.54	0.0012 J	0.41	2.1	0.43	0.0039 J	3
Benzaldehyde	mg/kg	120,000	0.073 U	0.019 J	0.073 U	0.025 J	0.11 J	0.071 U	0.074 U	0.73 U	0.065 J	0.07 U	0.077 U
Benzo[a]pyrene	mg/kg	2.1	0.013	0.012 J	0.0099	0.8	0.51	0.0072 U	0.39	1.7	0.41	0.0024 J	2
Benzo[b]fluoranthene	mg/kg	21	0.033	0.057 J	0.027	1.5	1	0.0033 J	0.94	2.6	0.91	0.0048 J	5.1
Benzo[g,h,i]perylene	mg/kg		0.021	0.023 J	0.0062 J	0.41	0.53	0.0072 U	0.13	0.54	0.14	0.0012 J	0.49
Benzo[k]fluoranthene	mg/kg	210	0.026	0.045 J	0.021	1.2	0.85	0.0024 J	0.79	1	0.72	0.0017 J	1.9
bis(2-Ethylhexyl)phthalate	mg/kg	160	0.047 J	0.033 J	0.073 U	0.057 B	0.09 B	0.071 U	0.074 U	0.73 U	0.019 J	0.07 U	0.077 U
Caprolactam	mg/kg	400,000	0.18 U	0.19 U	0.18 U	0.023 J	0.066 J	0.18 U	0.18 U	1.8 U	0.067 J	0.18 U	0.19 U
Carbazole	mg/kg		0.073 U	0.074 U	0.073 U	0.078 J	0.075 J	0.071 U	0.043 J	0.56 J	0.11	0.07 U	0.029 J
Chrysene	mg/kg	2,100	0.022	0.065 J	0.014	0.82	0.58	0.0029 J	0.36	2	0.45	0.0024 J	2
Dibenz[a,h]anthracene	mg/kg	2.1	0.0034 J	0.074 U	0.0016 J	0.15	0.15	0.0072 U	0.056	0.29	0.059	0.0071 U	0.28
Di-n-butylphthalate	mg/kg	82,000	0.12 B	0.074 U	0.073 U	0.05 B	0.058 B	0.071 U	0.074 U	0.73 U	0.019 J	0.07 U	0.077 U
Di-n-octylphthalate	mg/kg	8,200	0.073 UJ	0.074 UJ	0.073 U	0.073 UJ	0.082 UJ	0.071 U	0.074 U	0.73 U	0.08 U	0.051 J	0.077 U
Fluoranthene	mg/kg	30,000	0.035	0.055 J	0.032	1.3	0.9	0.0032 J	0.71	3.4	0.47	0.0054 J	3.2
Fluorene	mg/kg	30,000	0.0013 J	0.074 UJ	0.0073 UJ	0.094	0.053 J	0.0072 U	0.0085	0.12	0.04	0.0071 U	0.025
Hexachloroethane	mg/kg	8	0.073 U	0.074 U	0.073 U	0.073 U	0.082 U	0.071 U	0.074 U	0.73 U	0.018 J	0.07 U	0.077 U
Indeno[1,2,3-c,d]pyrene	mg/kg	21	0.011	0.074 U	0.0058 J	0.49	0.41	0.0072 U	0.15	0.64	0.14	0.0071 U	0.66
Naphthalene	mg/kg	17	0.0094	0.074 UJ	0.0061 J	0.18	0.48	0.0072 U	0.1	0.12	0.18	0.0071 U	0.042
N-Nitrosodiphenylamine	mg/kg	470	0.073 U	0.074 U	0.073 U	0.073 U	0.082 U	0.071 U	0.074 U	0.73 U	0.018 J	0.07 U	0.077 U
Phenanthrene	mg/kg		0.016	0.022 J	0.02 J	1	1.2	0.0048 J	0.42	1.8	0.38	0.0031 J	0.42
Phenol	mg/kg	250,000	0.073 UJ	0.074 R	0.073 R	0.073 U	0.046 J	0.071 U	0.074 U	0.73 U	0.08 U	0.07 U	0.077 U
Pyrene	mg/kg	23,000	0.03	0.077	0.025	0.99	0.73	0.0023 J	0.63	2.8	0.45	0.0046 J	3.2
PCBs													
Aroclor 1260	mg/kg	0.99	0.018 U	0.018 U	N/A	0.019 U	N/A	0.018 U	N/A	0.092 U	N/A	0.018 U	N/A
PCBs (total)	mg/kg	0.97	0.13 U	0.13 U	N/A	0.13 U	N/A	0.16 U	N/A	0.83 U	N/A	0.16 U	N/A
TPH/Oil and Grease													
Diesel Range Organics	mg/kg	6,200	113 J	507 J	31.3 J	53.3 J	90.5 J	4.4 J	63.2	125	133	7.7	41.7
Gasoline Range Organics	mg/kg	6,200	4.1 B	4.7 B	4.3 B	3.4 B	3.5 B	11.4 U	10.8 U	12.5 U	3.4 J	9.2 U	3 J
Oil and Grease	mg/kg	6,200	436 J-	2,440	254	460	552	97.9 J	369	497	371	64.3 J	251

Detections in bold

Values in red indicate an exceedance of the Project Action Limit (PAL)

N/A indicates that the parameter was not analyzed for this sample

* indicates non-validated data

^ PAH compounds were analyzed via SIM

U: This analyte was not detected in the sample. The numeric value represents the sample quantitation/detection limit.

UJ: This analyte was not detected in the sample. The actual quantitation/detection limit may be higher than reported.

J: The positive result reported for this analyte is a quantitative estimate.

J-: The positive result reported for this analyte is a quantitative estimate but may be biased low.

B: This analyte was not detected substantially above the level of the associated method blank/preparation or field blank.

R: The result for this analyte is unreliable. Additional data is needed to confirm or disprove the presence of this analyte in the sample.

Table 1
Summary of Organics Detected in Soil
Sub-Parcel B2-1
Tradeport Atlantic
Sparrows Point, Maryland

Parameter	Units	PAL	B2-065-SB-1*	B2-065-SB-4.5*	B2-066-SB-1*	B2-066-SB-5*	B2-067-SB-1*	B2-067-SB-5*	B2-068-SB-1*	B2-068-SB-5*	B2-069-SB-1*	B2-069-SB-4*
Semi-Volatile Organic Compounds^												
1,1-Biphenyl	mg/kg	200	0.086 U	0.077 U	0.078 U	0.76 U	0.073 U	0.072 U	0.072 U	0.077 U	0.072 U	0.073 U
1,2,4,5-Tetrachlorobenzene	mg/kg	350	0.086 U	0.077 U	0.078 U	0.76 U	0.073 U	0.072 U	0.072 U	0.077 U	0.072 U	0.073 U
2,4-Dimethylphenol	mg/kg	16,000	0.086 U	0.077 U	0.078 U	0.76 U	0.073 U	0.072 U	0.072 U	0.077 U	0.072 U	0.073 U
2-Methylnaphthalene	mg/kg	3,000	0.0072 J	0.011	0.0082	0.38	0.028	0.002 J	0.0067 J	0.031	0.0056 J	0.0085
2-Methylphenol	mg/kg	41,000	0.086 U	0.077 U	0.078 U	0.76 U	0.073 U	0.072 U	0.072 U	0.077 U	0.072 U	0.073 U
3&4-Methylphenol(m&p Cresol)	mg/kg	41,000	0.17 U	0.15 U	0.16 U	1.5 U	0.15 U	0.14 U	0.14 U	0.15 U	0.14 U	0.15 U
Acenaphthene	mg/kg	45,000	0.00074 J	0.00078 J	0.00089 J	0.034	0.002 J	0.0072 U	0.00092 J	0.012	0.0008 J	0.0016 J
Acenaphthylene	mg/kg	45,000	0.0016 J	0.0053 J	0.0012 J	0.33	0.0082	0.0072 U	0.0041 J	0.022	0.0012 J	0.025
Acetophenone	mg/kg	120,000	0.086 U	0.077 U	0.078 U	0.76 U	0.073 U	0.072 U	0.072 U	0.077 U	0.072 U	0.073 U
Anthracene	mg/kg	230,000	0.0053 J	0.0027 J	0.0042 J	0.28	0.0077	0.0006 J	0.0049 J	0.06	0.0019 J	0.036
Benz[a]anthracene	mg/kg	21	0.018	0.012	0.014	0.77	0.03	0.003 J	0.024	0.25	0.0057 J	0.1
Benzaldehyde	mg/kg	120,000	0.086 U	0.077 U	0.078 U	0.76 U	0.073 U	0.072 U	0.072 U	0.017 J	0.072 U	0.073 U
Benzo[a]pyrene	mg/kg	2.1	0.019	0.012	0.0085	1.2	0.027	0.0015 J	0.025	0.24	0.0031 J	0.11
Benzo[b]fluoranthene	mg/kg	21	0.053	0.034	0.03	2.8	0.13	0.0051 J	0.064	0.37	0.014	0.3
Benzo[g,h,i]perylene	mg/kg		0.019	0.01	0.014	0.042	0.038	0.0012 J	0.02	0.098	0.0036 J	0.036
Benzo[k]fluoranthene	mg/kg	210	0.042	0.027	0.022	0.79	0.1	0.004 J	0.051	0.12	0.01	0.085
bis(2-Ethylhexyl)phthalate	mg/kg	160	0.086 U	0.077 U	0.078 U	0.76 U	0.015 J	0.072 U	0.024 J	0.077 U	0.072 U	0.073 U
Caprolactam	mg/kg	400,000	0.21 U	0.19 U	0.2 U	1.9 U	0.18 U	0.18 U	0.18 U	0.19 U	0.18 U	0.18 U
Carbazole	mg/kg		0.086 U	0.077 U	0.078 U	0.76 U	0.073 U	0.072 U	0.072 U	0.044 J	0.072 U	0.073 U
Chrysene	mg/kg	2,100	0.027	0.016	0.026	0.85	0.11	0.0027 J	0.026	0.22	0.011	0.13
Dibenz[a,h]anthracene	mg/kg	2.1	0.0049 J	0.0034 J	0.0024 J	0.26	0.0088	0.0072 U	0.0047 J	0.038	0.0072 U	0.015
Di-n-butylphthalate	mg/kg	82,000	0.024 J	0.02 J	0.078 U	0.76 U	0.073 U	0.072 U	0.072 U	0.077 U	0.072 U	0.073 U
Di-n-ocetylphthalate	mg/kg	8,200	0.086 U	0.077 U	0.078 U	0.76 U	0.073 U	0.072 U	0.058 J	0.077 U	0.072 U	0.073 U
Fluoranthene	mg/kg	30,000	0.029	0.025	0.058	0.83	0.22	0.0065 J	0.048	0.43	0.017	0.13
Fluorene	mg/kg	30,000	0.0012 J	0.0013 J	0.0012 J	0.043	0.0022 J	0.0072 U	0.001 J	0.016	0.00057 J	0.0021 J
Hexachloroethane	mg/kg	8	0.086 U	0.077 U	0.078 U	0.76 U	0.073 U	0.072 U	0.072 U	0.077 U	0.072 U	0.073 U
Indeno[1,2,3-c,d]pyrene	mg/kg	21	0.015	0.0088	0.0073 J	0.54	0.028	0.0072 U	0.016	0.1	0.0019 J	0.04
Naphthalene	mg/kg	17	0.012	0.046	0.0047 J	0.28	0.033	0.0044 J	0.0068 J	0.037	0.0032 J	0.0087
N-Nitrosodiphenylamine	mg/kg	470	0.086 U	0.077 U	0.078 U	0.76 U	0.073 U	0.072 U	0.072 U	0.077 U	0.072 U	0.073 U
Phenanthrene	mg/kg		0.025	0.018	0.079	0.52	0.34	0.0051 J	0.027	0.25	0.025	0.039
Phenol	mg/kg	250,000	0.086 U	0.077 U	0.078 U	0.76 U	0.073 U	0.072 U	0.072 U	0.077 U	0.072 U	0.073 U
Pyrene	mg/kg	23,000	0.027	0.021	0.051	0.81	0.15	0.0051 J	0.046	0.38	0.017	0.16
PCBs												
Aroclor 1260	mg/kg	0.99	0.062	N/A	0.02 U	N/A	0.018 U	N/A	0.018 U	N/A	0.018 U	N/A
PCBs (total)	mg/kg	0.97	0.062 J	N/A	0.18 U	N/A	0.17 U	N/A	0.16 U	N/A	0.16 U	N/A
TPH/Oil and Grease												
Diesel Range Organics	mg/kg	6,200	49.7	38.8	17.2	61.5	167	14.3	42.6	93.6	14.8	15.1
Gasoline Range Organics	mg/kg	6,200	12.7 U	8.1 U	11.7 U	3.8 J	8.7 U	8.7 U	8.4 U	12.4 U	8.8 U	9.9 U
Oil and Grease	mg/kg	6,200	118 J	275	192	1,110	812	94.4 J	178	253	200	129

Detections in bold

Values in red indicate an exceedance of the Project Action Limit (PAL)

N/A indicates that the parameter was not analyzed for this sample

* indicates non-validated data

^ PAH compounds were analyzed via SIM

U: This analyte was not detected in the sample. The numeric value represents the sample quantitation/detection limit.

UJ: This analyte was not detected in the sample. The actual quantitation/detection limit may be higher than reported.

J: The positive result reported for this analyte is a quantitative estimate.

J-: The positive result reported for this analyte is a quantitative estimate but may be biased low.

B: This analyte was not detected substantially above the level of the associated method blank/preparation or field blank.

R: The result for this analyte is unreliable. Additional data is needed to confirm or disprove the presence of this analyte in the sample.

Table 2
Summary of Inorganics Detected in Soil
Sub-Parcel B2-1
Tradepoint Atlantic
Sparrows Point, Maryland

Parameter	Units	PAL	B2-005A-SB-1	B2-005-SB-1	B2-005-SB-5	B2-006-SB-1	B2-006-SB-4	B2-062-SB-1*
Metals								
Aluminum	mg/kg	1,100,000	12,800	14,000	10,400	18,800	11,100	7,610
Arsenic	mg/kg	3	3.3 J	2.9	3	8.9	8.9	2.1 U
Barium	mg/kg	220,000	59.7	98.5 J	39.3 J	174	125	35
Beryllium	mg/kg	2,300	0.35 B	0.88	0.84 U	2.8	1.7	0.84 U
Cadmium	mg/kg	980	1.3 U	1.2 U	0.5 J	1.7	0.77 J	1.3 U
Chromium	mg/kg	120,000	1,460	970	1,420	413	72.8	1,190
Chromium VI	mg/kg	6.3	4 J-	9.8 J-	3.6 J-	0.71 B	0.61 B	9.8
Cobalt	mg/kg	350	0.79 J	1.7 J	1.6 J	13	11.3	4.2 U
Copper	mg/kg	47,000	21.8	28.2 J	28 J	92.1	66	10.1
Iron	mg/kg	820,000	189,000	150,000	216,000	156,000	97,500	159,000
Lead	mg/kg	800	7.3	8.5	6.4	152	84.5	4.6
Manganese	mg/kg	26,000	33,400	24,600 J	34,000 J	10,700	1,730	28,800
Mercury	mg/kg	350	0.013 J	0.11 U	0.097 U	0.061 J	0.21	0.1 U
Nickel	mg/kg	22,000	16.7 J	19.9	21.5	49.2 J	30.8 J	13
Silver	mg/kg	5,800	25 J	24.6	27.5	18.4 J	6 J	3.7
Vanadium	mg/kg	5,800	865	660	755	707	88.2	616
Zinc	mg/kg	350,000	64.5	114	56.8	433	224	19.2
Other								
Cyanide	mg/kg	150	0.23 J	0.29 J+	0.14 J+	1 J	0.86 J	0.14 J

Detections in bold

Values in red indicate an exceedance of the Project Action Limit (PAL)

* indicates non-validated data

U: This analyte was not detected in the sample. The numeric value represents the sample quantitation/detection limit.

J: The positive result reported for this analyte is a quantitative estimate.

J+: The positive result reported for this analyte is a quantitative estimate but may be biased high.

J-: The positive result reported for this analyte is a quantitative estimate but may be biased low.

B: This analyte was not detected substantially above the level of the associated method blank/preparation or field blank.

Table 2
Summary of Inorganics Detected in Soil
Sub-Parcel B2-1
Tradepoint Atlantic
Sparrows Point, Maryland

Parameter	Units	PAL	B2-062-SB-4*	B2-063-SB-1*	B2-063-SB-5*	B2-064-SB-1*	B2-064-SB-5*
Metals							
Aluminum	mg/kg	1,100,000	13,900	19,700	11,500	17,300	7,860
Arsenic	mg/kg	3	11.2	4.6	29	2.1 U	5.8
Barium	mg/kg	220,000	118	273	184	193	75.3
Beryllium	mg/kg	2,300	0.91	2.6	1.5	1.9	0.47 J
Cadmium	mg/kg	980	0.55 J	1 J	2.5	1.3 U	1.4 U
Chromium	mg/kg	120,000	700	537	67.5	875	775
Chromium VI	mg/kg	6.3	1.1 U	1.1 U	1.2 U	2.5	1.2 U
Cobalt	mg/kg	350	8.1	4.7	15.7	0.93 J	6.8
Copper	mg/kg	47,000	68.2	42.7	189	19	43
Iron	mg/kg	820,000	145,000	78,500	45,800	141,000	149,000
Lead	mg/kg	800	197	100	374	7.4	48.2
Manganese	mg/kg	26,000	16,400	12,900	1,380	21,100	15,400
Mercury	mg/kg	350	0.11	0.15	0.15	0.099 U	0.019 J
Nickel	mg/kg	22,000	32.1	21.1	42.8	10.8	26.9
Silver	mg/kg	5,800	2 J	2.6 U	2.9 U	2.5 J	1.7 J
Vanadium	mg/kg	5,800	427	612	79.3	405	335
Zinc	mg/kg	350,000	720	414	780	35.9	140
Other							
Cyanide	mg/kg	150	0.96 J	0.46 J	0.67 J	0.32 J	0.29 J

Detections in bold

Values in red indicate an exceedance of the Project Action Limit (PAL)

* indicates non-validated data

U: This analyte was not detected in the sample. The numeric value represents the sample quantitation/detection limit.

J: The positive result reported for this analyte is a quantitative estimate.

J+: The positive result reported for this analyte is a quantitative estimate but may be biased high.

J-: The positive result reported for this analyte is a quantitative estimate but may be biased low.

B: This analyte was not detected substantially above the level of the associated method blank/preparation or field blank.

Table 2
Summary of Inorganics Detected in Soil
Sub-Parcel B2-1
Tradepoint Atlantic
Sparrows Point, Maryland

Parameter	Units	PAL	B2-065-SB-1*	B2-065-SB-4.5*	B2-066-SB-1*	B2-066-SB-5*	B2-067-SB-1*
Metals							
Aluminum	mg/kg	1,100,000	10,600	38,800	19,500	8,850	15,300
Arsenic	mg/kg	3	2.6 U	2.2 J	2.3 U	7.5	2.4
Barium	mg/kg	220,000	56.2	1,700	85.6	222	93.9
Beryllium	mg/kg	2,300	0.31 J	2.9	0.84 J	0.63 J	0.72 J
Cadmium	mg/kg	980	1.5 U	1.4 U	1.4 U	1.4 U	1.3 U
Chromium	mg/kg	120,000	695	35	1,140	71.9	1,220
Chromium VI	mg/kg	6.3	12.5	1.1 U	8.9	1.2 U	1.4
Cobalt	mg/kg	350	0.86 J	1.2 J	0.94 J	13.3	1.6 J
Copper	mg/kg	47,000	21.4	10.2	22.6	83.2	46.3
Iron	mg/kg	820,000	83,200	8,940	154,000	88,900	171,000
Lead	mg/kg	800	29.1	8	18.9	114	25.2
Manganese	mg/kg	26,000	14,400	5,910	23,400	2,570	28,000
Mercury	mg/kg	350	0.06 J	0.12 U	0.11 U	0.021 J	0.013 J
Nickel	mg/kg	22,000	7.5 J	1.9 J	18	30.5	14.5
Silver	mg/kg	5,800	3.1 U	2.7 U	2.3 J	2.8 U	2.5 U
Vanadium	mg/kg	5,800	594	212	790	228	819
Zinc	mg/kg	350,000	257	31.3	106	151	134
Other							
Cyanide	mg/kg	150	0.36 J	1.1 J	0.27 J	0.9 J	0.3 J

Detections in bold

Values in red indicate an exceedance of the Project Action Limit (PAL)

* indicates non-validated data

U: This analyte was not detected in the sample. The numeric value represents the sample quantitation/detection limit.

J: The positive result reported for this analyte is a quantitative estimate.

J+: The positive result reported for this analyte is a quantitative estimate but may be biased high.

J-: The positive result reported for this analyte is a quantitative estimate but may be biased low.

B: This analyte was not detected substantially above the level of the associated method blank/preparation or field blank.

Table 2
Summary of Inorganics Detected in Soil
Sub-Parcel B2-1
Tradepoint Atlantic
Sparrows Point, Maryland

Parameter	Units	PAL	B2-067-SB-5*	B2-068-SB-1*	B2-068-SB-5*	B2-069-SB-1*	B2-069-SB-4*
Metals							
Aluminum	mg/kg	1,100,000	9,770	11,900	16,300	8,060	16,300
Arsenic	mg/kg	3	3.1	2.2 U	6.6	2.1 U	2.6
Barium	mg/kg	220,000	22.4	48.3	153	45.8	126
Beryllium	mg/kg	2,300	0.87 U	0.87 U	2	0.15 J	1.9
Cadmium	mg/kg	980	1.3 U	1.3 U	0.63 J	1.3 U	1.3 U
Chromium	mg/kg	120,000	1,510	1,580	304	1,290	1,050
Chromium VI	mg/kg	6.3	1.4	5.5	1.1 U	7.4	0.7 J
Cobalt	mg/kg	350	2.1 J	4.3 U	6.1	1.2 J	2.2 J
Copper	mg/kg	47,000	24.1	30.5	49.8	17.1	27.3
Iron	mg/kg	820,000	212,000	178,000	94,800	174,000	138,000
Lead	mg/kg	800	5.1	26.8	136	7.5	11
Manganese	mg/kg	26,000	32,600	29,500	7,480	31,300	23,800
Mercury	mg/kg	350	0.11 U	0.0093 J	0.16	0.11 U	0.11 U
Nickel	mg/kg	22,000	24.3	10.6	28	17.1	22.6
Silver	mg/kg	5,800	2.6 U	2.6 U	2.7 U	3.9	2.7
Vanadium	mg/kg	5,800	761	827	199	537	554
Zinc	mg/kg	350,000	27.2	68.2	265	42.5	47.4
Other							
Cyanide	mg/kg	150	0.14 J	0.35 J	3.6	0.19 J	0.18 J

Detections in bold

Values in red indicate an exceedance of the Project Action Limit (PAL)

* indicates non-validated data

U: This analyte was not detected in the sample. The numeric value represents the sample quantitation/detection limit.

J: The positive result reported for this analyte is a quantitative estimate.

J+: The positive result reported for this analyte is a quantitative estimate but may be biased high.

J-: The positive result reported for this analyte is a quantitative estimate but may be biased low.

B: This analyte was not detected substantially above the level of the associated method blank/preparation or field blank.

**Table 4 - Sub-Parcel B2-1
COPC Screening Analysis**

Parameter	CAS#	Location of Max Result	Max Detection (mg/kg)	Final Flag	Min Detection (mg/kg)	Average Detection (mg/kg)	Total Samples	Frequency of Detection (%)	Cancer TR=1E-06 (mg/kg)	Non-Cancer HQ=0.1 (mg/kg)	COPC?
1,1-Biphenyl	92-52-4	B2-063-SB-5	0.08		0.019	0.05	21	19.05	410	20	no
1,2,4,5-Tetrachlorobenzene	95-94-3	B2-006-SB-4	0.019	J	0.019	0.02	21	4.76		35	no
2,4-Dimethylphenol	105-67-9	B2-006-SB-4	0.059	J	0.059	0.06	19	5.26		1,600	no
2-Methylnaphthalene	91-57-6	B2-006-SB-4	0.6		0.001	0.08	21	95.24		300	no
2-Methylphenol	95-48-7	B2-006-SB-4	0.039	J	0.039	0.04	19	5.26		4,100	no
Acenaphthene	83-32-9	B2-006-SB-1	0.058	J	0.00074	0.01	21	76.19		4,500	no
Acenaphthylene	208-96-8	B2-064-SB-5	0.59		0.00056	0.09	21	85.71			no
Acetophenone	98-86-2	B2-063-SB-5	0.048	J	0.02	0.04	21	14.29		12,000	no
Aluminum	7429-90-5	B2-065-SB-4.5	38,800		7,610	14,302	21	100.00		110,000	no
Anthracene	120-12-7	B2-064-SB-5	0.58		0.0006	0.10	21	100.00		23,000	no
Aroclor 1260	11096-82-5	B2-065-SB-1	0.062		0.062	0.06	11	9.09	0.99		no
Arsenic	7440-38-2	B2-063-SB-5	29		2.2	6.80	21	71.43	3	48	YES (C)
Barium	7440-39-3	B2-065-SB-4.5	1,700		22.4	187	21	100.00		22,000	no
Benz[a]anthracene	56-55-3	B2-064-SB-5	3		0.0012	0.41	21	100.00	21		no
Benzaldehyde	100-52-7	B2-006-SB-4	0.11	J	0.017	0.05	21	23.81	820	12,000	no
Benzo[a]pyrene	50-32-8	B2-064-SB-5	2		0.0015	0.37	21	95.24	2.1	22	no
Benzo[b]fluoranthene	205-99-2	B2-064-SB-5	5.1		0.0033	0.76	21	100.00	21		no
Benzo[g,h,i]perylene	191-24-2	B2-063-SB-1	0.54		0.0012	0.13	21	95.24			no
Benzo[k]fluoranthene	207-08-9	B2-064-SB-5	1.9		0.0017	0.37	21	100.00	210		no
Beryllium	7440-41-7	B2-065-SB-4.5	2.9		0.15	1.39	21	76.19	6,900	230	no
bis(2-Ethylhexyl)phthalate	117-81-7	B2-005A-SB-1	0.047	J	0.015	0.03	21	23.81	160	1,600	no
Cadmium	7440-43-9	B2-063-SB-5	2.5		0.5	1.09	21	33.33	9,300	98	no
Caprolactam	105-60-2	B2-063-SB-5	0.067	J	0.023	0.05	21	14.29		40,000	no
Carbazole	86-74-8	B2-063-SB-1	0.56	J	0.029	0.13	21	33.33			no
Chromium	7440-47-3	B2-068-SB-1	1,580		35	827	21	100.00		180,000	no
Chromium VI	18540-29-9	B2-065-SB-1	12.5		0.7	5.63	21	57.14	6.3	350	YES (C)
Chrysene	218-01-9	B2-063-SB-1 & B2-064-SB-5	2		0.0024	0.37	21	100.00	2,100		no
Cobalt	7440-48-4	B2-063-SB-5	15.7		0.79	4.95	21	90.48	1,900	35	no
Copper	7440-50-8	B2-063-SB-5	189		10.1	44.8	21	100.00		4,700	no
Cyanide	57-12-5	B2-068-SB-5	3.6		0.14	0.61	21	100.00		120	no
Dibenz[a,h]anthracene	53-70-3	B2-063-SB-1	0.29		0.0016	0.08	21	76.19	2.1		no
Di-n-butylphthalate	84-74-2	B2-065-SB-1	0.024	J	0.019	0.02	21	14.29		8,200	no
Di-n-octylphthalate	117-84-0	B2-068-SB-1	0.058	J	0.051	0.05	21	9.52		820	no

**Table 4 - Sub-Parcel B2-1
COPC Screening Analysis**

Parameter	CAS#	Location of Max Result	Max Detection (mg/kg)	Final Flag	Min Detection (mg/kg)	Average Detection (mg/kg)	Total Samples	Frequency of Detection (%)	Cancer TR=1E-06 (mg/kg)	Non-Cancer HQ=0.1 (mg/kg)	COPC?
Fluoranthene	206-44-0	B2-063-SB-1	3.4		0.0032	0.57	21	100.00		3,000	no
Fluorene	86-73-7	B2-063-SB-1	0.12		0.00057	0.03	21	76.19		3,000	no
Hexachloroethane	67-72-1	B2-063-SB-5	0.018	J	0.018	0.02	21	4.76	8	46	no
Indeno[1,2,3-c,d]pyrene	193-39-5	B2-064-SB-5	0.66		0.0019	0.19	21	80.95	21		no
Iron	7439-89-6	B2-005-SB-5	216,000		8,940	134,745	21	100.00		82,000	YES (NC)
Lead^	7439-92-1	B2-063-SB-5	374		4.6	65.3	21	100.00		800	no
Manganese	7439-96-5	B2-005-SB-5	34,000	J	1,380	19,018	21	100.00		2,600	YES (NC)
Mercury	7439-97-6	B2-006-SB-4	0.21		0.0093	0.08	21	57.14		35	no
Naphthalene	91-20-3	B2-006-SB-4	0.48		0.0032	0.09	21	85.71	17	59	no
Nickel	7440-02-0	B2-006-SB-1	49.2	J	1.9	21.9	21	100.00	64,000	2,200	no
N-Nitrosodiphenylamine	86-30-6	B2-063-SB-5	0.018	J	0.018	0.02	21	4.76	470		no
PCBs (total)*	1336-36-3	B2-065-SB-1	0.062	J	0.062	0.06	11	9.09	0.94		no
Phenanthrene	85-01-8	B2-063-SB-1	1.8		0.0031	0.31	21	100.00			no
Phenol	108-95-2	B2-006-SB-4	0.046	J	0.046	0.05	19	5.26		25,000	no
Pyrene	129-00-0	B2-064-SB-5	3.2		0.0023	0.51	21	100.00		2,300	no
Silver	7440-22-4	B2-005-SB-5	27.5		1.7	10.0	21	57.14		580	no
Vanadium	7440-62-2	B2-005A-SB-1	865		79.3	527	21	100.00		580	YES (NC)
Zinc	7440-66-6	B2-063-SB-5	780		19.2	197	21	100.00		35,000	no

J: The positive result reported for this analyte is a quantitative estimate.

COPC: Constituent of Potential Concern

C = Compound was identified as a cancer COPC

NC = Compound was identified as a non-cancer COPC

TR = Target Risk

HQ = Hazard Quotient

*PCBs (total) include the sum of all detected aroclor mixtures, including those without regional screening levels (e.g. Aroclor 1262, Aroclor 1268) which are not displayed.

^The COPC screening level for lead was not adjusted to the HQ=0.1 because lead is not assessed in the SLRA. The 800 mg/kg PAL is relevant to the Adult Lead Model procedure.

**Table 5 - Sub-Parcel B2-1
Assessment of Lead**

Exposure Unit	Surface/Sub-Surface	Arithmetic Mean (mg/kg)
LOD (7.2 ac.)	Surface	35.2
	Sub-Surface	98.4
	Pooled	65.3

Adult Lead Model (ALM) Risk Levels	
Soil Concentration (mg/kg)	Probability of Blood Concentration of 10 ug/dL
2,518 mg/kg	5%
3,216 mg/kg	10%

**Table 6 - Sub-Parcel B2-1
Soil Exposure Point Concentrations**

			LOD (7.2 ac.)					
			Surface Soil EPCs		Sub-Surface Soil EPCs		Pooled Soil EPCs	
Parameter	Cancer COPC Screening Level (mg/kg)	Non-Cancer COPC Screening Level (mg/kg)	EPC Type LOD	EPC LOD (mg/kg)	EPC Type LOD	EPC LOD (mg/kg)	EPC Type LOD	EPC LOD (mg/kg)
Arsenic	3.00	48.0	95% KM (t) UCL	4.36	95% Student's-t UCL	12.6	95% GROS Adjusted Gamma UCL	10.6
Chromium VI	6.30	350	95% KM (t) UCL	8.06	Maximum Value	3.60	95% KM (t) UCL	4.98
Iron		82,000	95% Student's-t UCL	168,287	95% Student's-t UCL	157,957	95% Student's-t UCL	154,817
Manganese		2,600	95% Student's-t UCL	27,729	95% Student's-t UCL	21,352	95% Student's-t UCL	23,195
Vanadium		580	95% Student's-t UCL	753	95% Student's-t UCL	511	95% Student's-t UCL	623

Bold indicates EPC higher than lowest COPC Screening Level
COPC = Constituent of Potential Concern

**Table 7 - Sub-Parcel B2-1
Surface Soils
Composite Worker Risk Ratios**

		LOD (7.2 ac.)				
		Composite Worker				
Parameter	Target Organ	EPC mg/kg	RSLs		Risk Estimates	
			Cancer	Non-Cancer	Risk	HQ
Arsenic	Cardiovascular; Dermal	4.36	3.00	480	1.5E-06	0.009
Chromium VI	Respiratory	8.06	6.30	3,500	1.3E-06	0.002
Iron	Gastrointestinal	168,287		820,000		0.2
Manganese	Nervous	27,729		26,000		1
Vanadium	Dermal	753		5,800		0.1
					3E-06	↓

RSLs were obtained from the EPA Regional Screening Levels at https://epa-prgs.ornl.gov/cgi-bin/chemicals/csl_search

Total HI	Cardiovascular	0
	Dermal	0
	Respiratory	0
	Gastrointestinal	0
	Nervous	1

**Table 8 - Sub-Parcel B2-1
Sub-Surface Soils
Composite Worker Risk Ratios**

Parameter		Target Organ		LOD (7.2 ac.)			
				Composite Worker			
				RSLs		Risk Estimates	
				Cancer	Non-Cancer	Risk	HQ
		EPC mg/kg					
Arsenic	Cardiovascular; Dermal	12.6	3.00	480	4.2E-06	0.03	
Chromium VI	Respiratory	3.60	6.30	3,500	5.7E-07	0.001	
Iron	Gastrointestinal	157,957		820,000		0.2	
Manganese	Nervous	21,352		26,000		0.8	
Vanadium	Dermal	511		5,800		0.09	
					5E-06	↓	

RSLs were obtained from the EPA Regional Screening Levels at https://epa-prgs.ornl.gov/cgi-bin/chemicals/csl_search

Bold indicates maximum value

Total HI	Cardiovascular	0
	Dermal	0
	Respiratory	0
	Gastrointestinal	0
	Nervous	1

**Table 9 - Sub-Parcel B2-1
Pooled Soils
Composite Worker Risk Ratios**

Parameter		Target Organ		LOD (7.2 ac.)			
				Composite Worker			
				RSLs		Risk Estimates	
				Cancer	Non-Cancer	Risk	HQ
		EPC mg/kg					
Arsenic	Cardiovascular; Dermal	10.6	3.00	480	3.5E-06	0.02	
Chromium VI	Respiratory	4.98	6.30	3,500	7.9E-07	0.001	
Iron	Gastrointestinal	154,817		820,000		0.2	
Manganese	Nervous	23,195		26,000		0.9	
Vanadium	Dermal	623		5,800		0.1	
					4E-06	↓	

RSLs were obtained from the EPA Regional Screening Levels at https://epa-prgs.ornl.gov/cgi-bin/chemicals/csl_search

Total HI	Cardiovascular	0
	Dermal	0
	Respiratory	0
	Gastrointestinal	0
	Nervous	1

**Table 10 - Sub-Parcel B2-1
Surface Soils
Construction Worker Risk Ratios**

45 Day		LOD (7.2 ac.)				
		EPC mg/kg	Construction Worker			
Parameter	Target Organ		SSLs		Risk Estimates	
			Cancer	Non-Cancer	Risk	HQ
Arsenic	Cardiovascular; Dermal	4.36	83.9	530	5.2E-08	0.008
Chromium VI	Respiratory	8.06	115	4,430	7.0E-08	0.002
Iron	Gastrointestinal	168,287		1,336,341		0.13
Manganese	Nervous	27,729		20,451		1
Vanadium	Dermal	753		8,662		0.09
					1E-07	↓

SSLs calculated using equations in the EPA Supplemental Guidance dated 2002

Guidance Equation Input Assumptions:

- 5 cars/day (2 tons/car)
- 5 trucks/day (20 tons/truck)
- 3 meter source depth thickness

Total HI	Cardiovascular	0
	Dermal	0
	Respiratory	0
	Gastrointestinal	0
	Nervous	1

**Table 11 - Sub-Parcel B2-1
Sub-Surface Soils
Construction Worker Risk Ratios**

45 Day		LOD (7.2 ac.)				
		EPC mg/kg	Construction Worker			
SSLs			Risk Estimates			
Cancer	Non-Cancer		Risk	HQ		
Parameter	Target Organ					
Arsenic	Cardiovascular; Dermal	12.6	83.9	530	1.5E-07	0.02
Chromium VI	Respiratory	3.60	115	4,430	3.1E-08	0.0008
Iron	Gastrointestinal	157,957		1,336,341		0.1
Manganese	Nervous	21,352		20,451		1
Vanadium	Dermal	511		8,662		0.06
					2E-07	↓

SSLs calculated using equations in the EPA Supplemental Guidance dated 2002

Guidance Equation Input Assumptions:

- 5 cars/day (2 tons/car)
- 5 trucks/day (20 tons/truck)
- 3 meter source depth thickness

Total HI	Cardiovascular	0
	Dermal	0
	Respiratory	0
	Gastrointestinal	0
	Nervous	1

Bold indicates maximum value

**Table 12 - Sub-Parcel B2-1
Pooled Soils
Construction Worker Risk Ratios**

45 Day		LOD (7.2 ac.)				
		EPC mg/kg	Construction Worker			
Parameter	Target Organ		SSLs		Risk Estimates	
			Cancer	Non-Cancer	Risk	HQ
Arsenic	Cardiovascular; Dermal	10.6	83.9	530	1.3E-07	0.02
Chromium VI	Respiratory	4.98	115	4,430	4.3E-08	0.001
Iron	Gastrointestinal	154,817		1,336,341		0.1
Manganese	Nervous	23,195		20,451		1
Vanadium	Dermal	623		8,662		0.07
					2E-07	↓

SSLs calculated using equations in the EPA Supplemental Guidance dated 2002

Guidance Equation Input Assumptions:

- 5 cars/day (2 tons/car)
- 5 trucks/day (20 tons/truck)
- 3 meter source depth thickness

Total HI	Cardiovascular	0
	Dermal	0
	Respiratory	0
	Gastrointestinal	0
	Nervous	1

"

"

"

"

"

"

"

"

"

APPENDIX B

"

"

"

"

"

"

"

"

"

"

"

"

Fitzell Substation Excavations

<i>Excavation type</i>	<i>Duration of Excavation *</i>
Crew A	
Transformer Foundations and Containment	
Transformer 110-1 (TA), 110-2 (TB), 110-3 (TC), 110-4 (TD)	<28 days
Crew A Total	<28 days
Crew B	
Circuit Breaker Foundations	
B13, B14, B23, B24	<14 days
13.8 kV Reactors	
FDR 6024, 6025, 6026, 6027	<7 days
13.8 kV Cap	
FDR 6029	<7 days
Crew B Total	<28 days
Crew C	
Ductbank	
TC to SWGR, TB to SWGR	<7 days
Switchgear Enclosure	
Enclosure	<7 days
34.5 kV Reactors	
FDR 34090 - 34096	<7 days
34.5 kV Capacitors	
FDR 34090 to 34095	<7 days
Crew C Total	<28 days

*** No crew will exceed 45 days ground intrusive work.**

Schedule provided by Tradepoint Atlantic on February 16, 2018

APPENDIX C

**Construction Worker Soil Screening Levels
45 Work Day Exposure
Calculation Spreadsheet - Sub-Parcel B2-1**

Description	Variable	Value
Days worked per week	DW	5
Exposure duration (yr)	ED	1
Hours worked per day	ET	8
A/constant (unitless) - particulate emission factor	Aconst	12.9351
B/constant (unitless) - particulate emission factor	Bconst	5.7383
C/constant (unitless) - particulate emission factor	Cconst	71.7711
Dispersion correction factor (unitless)	FD	0.185
Days per year with at least .01" precipitation	P	130
Target hazard quotient (unitless)	THQ	1
Body weight (kg)	BW	80
Averaging time - noncancer (yr)	ATnc	1
Soil ingestion rate (mg/d)	IR	330
Skin-soil adherence factor (mg/cm ²)	AF	0.3
Skin surface exposed (cm ²)	SA	3300
Event frequency (ev/day)	EV	1
Target cancer risk (unitless)	TR	01E-06
Averaging time - cancer (yr)	ATc	70
A/constant (unitless) - volatilization	Aconstv	2.4538
B/constant (unitless) - volatilization	Bconstv	17.566
C/constant (unitless) - volatilization	Cconstv	189.0426
Dry soil bulk density (kg/L)	Pb	1.5
Average source depth (m)	ds	3
Soil particle density (g/cm ³)	Ps	2.65
Total soil porosity	Lpore/Lsoil	0.43
Air-filled soil porosity	Lair/Lsoil	0.28

**Construction Worker Soil Screening Levels
45 Work Day Exposure
Calculation Spreadsheet - Sub-Parcel B2-1**

Area of site (ac)	Ac	7.2
Overall duration of construction (wk/yr)	EW	9
Exposure frequency (day/yr)	EF	45
Cars per day	Ca	5
Tons per car	CaT	2
Trucks per day	Tru	5
Tons per truck	TrT	20
Mean vehicle weight (tons)	w	11
Derivation of dispersion factor - particulate emission factor (g/m2-s per kg/m3)	Q/Csr	15.8
Overall duration of construction (hr)	tc	1,512
Overall duration of traffic (s)	Tt	1,296,000
Surface area (m2)	AR	29,137
Length (m)	LR	171
Distance traveled (km)	ΣVKT	77
Particulate emission factor (m3/kg)	PEFsc	69,566,110
Derivation of dispersion factor - volatilization (g/m2-s per kg/m3)	Q/Csa	8.88
Total time of construction (s)	Tcv	1,296,000

Input
Calculation

Chemical	RfD & RfC Sources	^Ingestion SF (mg/kg-day) ⁻¹	^Inhalation Unit Risk (ug/m ³) ⁻¹	^Subchronic RfD (mg/kg-day)	^Subchronic RfC (mg/m ³)	^GIABS	Dermally Adjusted RfD (mg/kg-day)	^ABS	^RBA	*Dia	*Diw	*Henry's Law Constant (unitless)	*Kd	*Koc	DA	Volatilization Factor - Unlimited Reservoir (m ³ /kg)	Carcinogenic Ingestion/ Dermal SL (SLing/der)	Carcinogenic Inhalation SL (SLinh)	Carcinogenic SL (mg/kg)	Non-Carcinogenic Ingestion/ Dermal SL (SLing/der)	Non-Carcinogenic Inhalation SL (SLinh)	Non-Carcinogenic SL (mg/kg)
Arsenic, Inorganic	I/C	1.50E+00	4.30E-03	3.00E-04	1.50E-05	1	3.00E-04	0.03	0.6			-	2.90E+01				84.2	27,557	83.9	541	25,392	530
Chromium(VI)	A/N/I	5.00E-01	8.40E-02	5.00E-03	3.00E-04	0.025	1.25E-04	0.01	1			-	1.90E+01				125	1,411	115	4,469	507,833	4,430
Iron	P	-	-	7.00E-01	-	1	7.00E-01	0.01	1			-	2.50E+01							1,336,341		1,336,341
Manganese (Non-diet)	I	-	-	2.40E-02	5.00E-05	0.04	9.60E-04	0.01	1			-	6.50E+01							26,967	84,639	20,451
Vanadium and Compounds	A	-	-	1.00E-02	1.00E-04	0.026	2.60E-04	0.01	1			-	1.00E+03							9,129	169,278	8,662

*chemical specific parameters found in Chemical Specific Parameters Spreadsheet at <https://www.epa.gov/risk/regional-screening-levels-rsls>

^chemical specific parameters found in Unpaved Road Traffic calculator at https://epa-prgs.ornl.gov/cgi-bin/chemicals/csl_search

I: chemical specific parameters found in the IRIS at <https://www.epa.gov/iris>

C: chemical specific parameters found in Cal EPA at <https://www.dtsc.ca.gov/AssessingRisk>

A: chemical specific parameters found in Agency for Toxic Substances and Disease Registry Minimal Risk Levels (MRLs) at https://www.atsdr.cdc.gov/mrls/pdfs/atsdr_mrls.pdf

P: chemical specific parameters found in the Database of EPA PPRTVs at <https://hhpprtv.ornl.gov/quickview/pprtv.php>

N: chemical specific parameters found in NJDEP

APPENDIX F

GENERAL NOTES:

1. ALL PIPES OR CONDUIT SHALL BE LEAK-PROOF AND WATERTIGHT. ALL JOINTS SHALL BE SEALED OR GASKETED.
2. ALL PIPES SHALL BE PROPERLY PLACED AND BEDDED TO PREVENT MISALIGNMENT OR LEAKAGE. PIPE BEDDING SHALL BE INSTALLED IN SUCH A MANNER AS TO MINIMIZE THE POTENTIAL FOR ACCUMULATION OF WATER AND CONCENTRATED INFILTRATION.
3. MINIMUM COVER ABOVE UTILITY SHALL BE BASED ON SPECIFIC UTILITY REQUIREMENTS.
4. TRENCHES SHALL BE BACKFILLED WITH BEDDING AND MATERIALS APPROVED BY MDEA. ~~UNAPPROVED~~

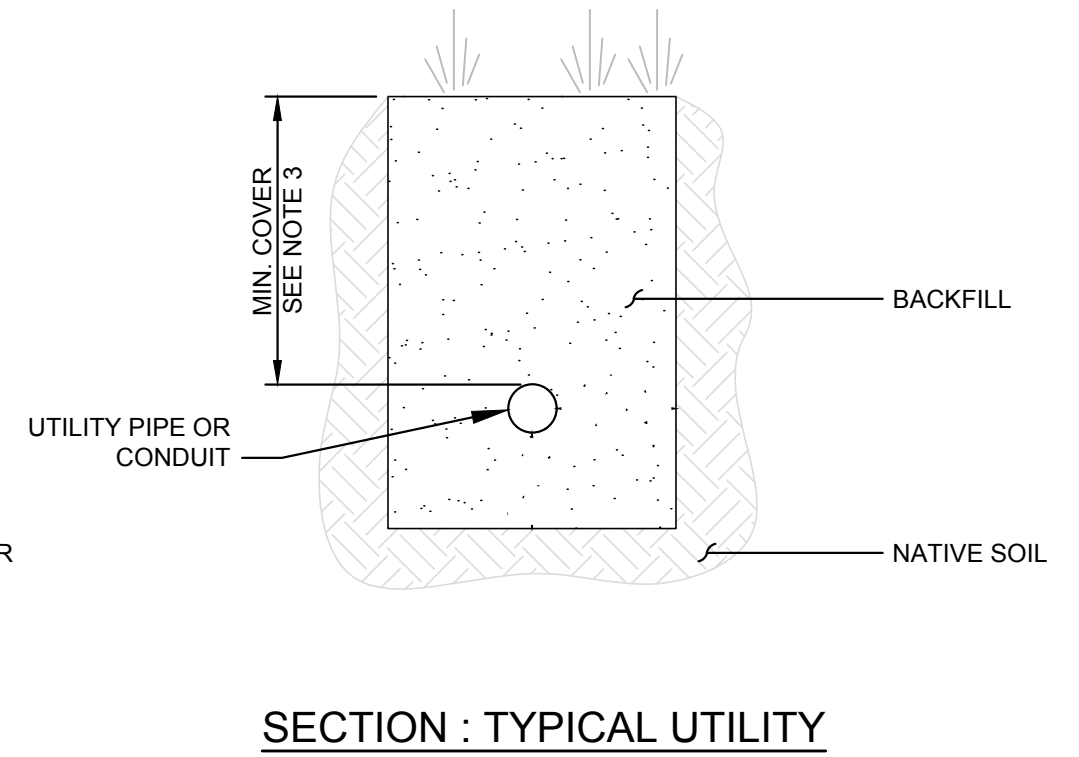
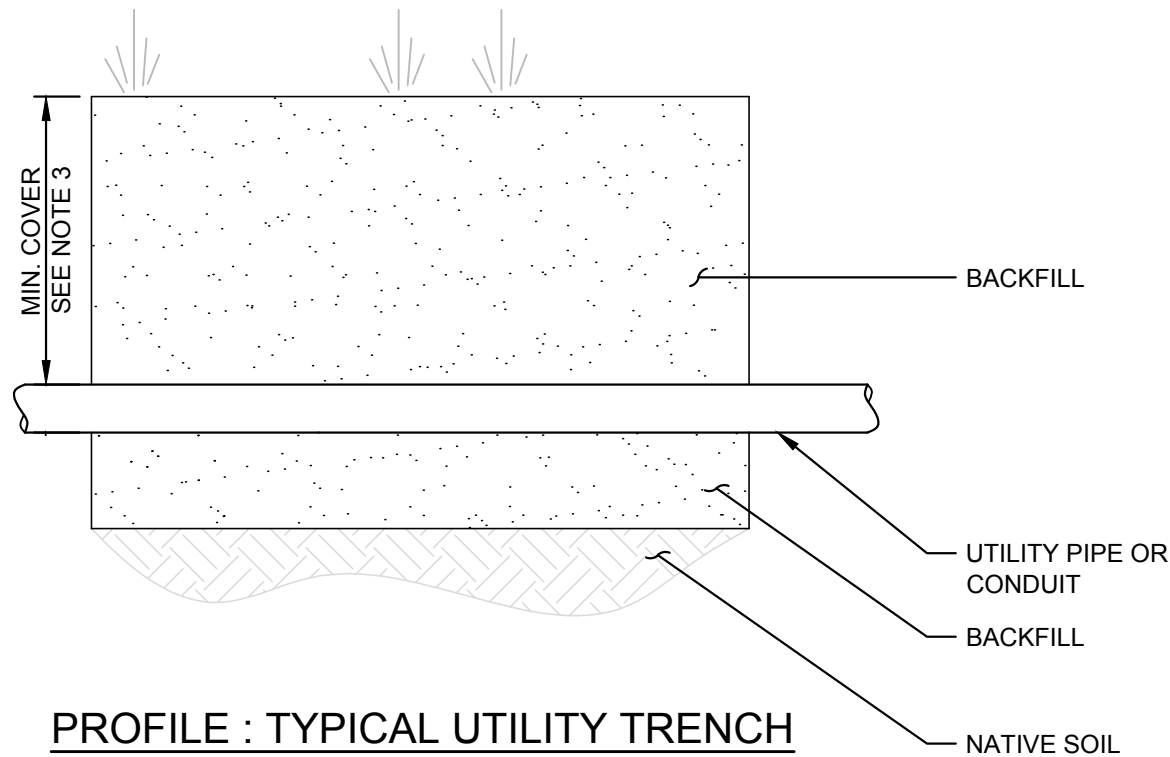

\\armgroup.lcl\CorpData\Projects\EnviroAnalytics\Group\160443M_EAG_TPA_Redevelopment\Drawings\Reference\Utility_Cross_Section_REV.dwg Plotted: January 11, 2018

This drawing, its contents, and each component of this drawing are the property of and proprietary to ARM Group Inc. and shall not be reproduced or used in any manner except for the purpose identified on the Title Block, and only by or on behalf of this client for the identified project unless otherwise authorized by the express, written consent of ARM Group Inc.

 ARM Group Inc. Earth Resource Engineers and Consultants www.armgroup.net	TYPICAL UTILITY CROSS SECTIONS Sparrows Point Site EnviroAnalytics Group, LLC		May 2018	Figure 1
			1/2" = 1'-0"	
			160443M	